

The Wireless World

THE PRACTICAL RADIO JOURNAL
25th Year of Publication

No. 849.

FRIDAY, DECEMBER 6TH, 1935.

VOL. XXXVII.

No. 23.

Proprietors: ILIFFE & SONS LTD.

Editor:
HUGH S. POCKOCK.

Editorial,
Advertising and Publishing Offices:
DORSET HOUSE, STAMFORD STREET,
LONDON, S.E.1.

Telephone: Waterloo 3333 (50 lines).
Telegrams: "Ethaworld, Sedist, London."

COVENTRY: Hertford Street.
Telegrams: "Autocar, Coventry." Telephone: 5210 Coventry.

BIRMINGHAM:
Guildhall Buildings, Navigation Street, 2.
Telegrams: "Autopress, Birmingham." Telephone: 2971 Midland (4 lines).

MANCHESTER: 260, Deansgate, 3.
Telegrams: "Iliffe, Manchester." Telephone: Blackfriars 4412 (4 lines).

GLASGOW: 26B, Renfield Street, C.2.
Telegrams: "Iliffe, Glasgow." Telephone: Central 4857.

PUBLISHED WEEKLY. ENTERED AS SECOND CLASS MATTER AT NEW YORK, N.Y.

Subscription Rates:

Home, £1 1s. 8d.; Canada, £1 1s. 8d.; other countries, £1 3s. 10d. per annum.

As many of the circuits and apparatus described in these pages are covered by patents, readers are advised, before making use of them, to satisfy themselves that they would not be infringing patents.

CONTENTS

	Page
Editorial Comment ..	577
Empire Broadcasting from Within ..	578
Wireless at Christmastime ..	582
Current Topics ..	584
An Introduction to Short Waves ..	585
Unbiased ..	586
H.M.V. "Popular" Radio Gramophone ..	588
Buying a New Receiver ..	590
An Unsung Pioneer ..	591
An Ideal Christmas Gift ..	593
Listeners' Guide for the Week ..	594
Ever Ready Model 5003 ..	596
Mica as a Diaphragm Material ..	598
"This Great Family" Christmas Day Broadcast ..	599
Hints and Tips ..	600
Broadcast Brevities ..	601
Letters to the Editor ..	602
Random Radiations ..	604
Sets for the Home Constructor ..	605
Principal Broadcasting Stations ..	606
Recent Inventions ..	608

Editorial Comment

Wireless for Christmas Presents Unlimited Variety of Choice

AS each Christmas comes round broadcasting plays an increasingly important part in bringing the atmosphere of Christmas into every home and linking together every part of the Empire in closer harmony. Each year we refer especially to the question of wireless in connection with Christmas presents because we feel that there can be no better gift than one which provides such lasting pleasure at so small a maintenance cost. Unquestionably broadcasting to-day is still the cheapest possible entertainment. Wireless has the advantage that as a present it is definitely a family gift of interest equally to everyone in the home. A wireless set can be given as a joint present with the assurance that it will give more pleasure than individual gifts where the sum expended would be divided up. Those who are interested in wireless as a hobby would no doubt prefer the parts for building a set such as the "Variable Selectivity Four" recently described, or they may want to add something to their present set, when there is a wide selection of possible gifts.

Wireless provides a good choice from complete radio gramophones down to a valve or other component, so that something wireless can come within the capacity of every pocket.

Christmas holidays are an occasion when spare time may be very usefully spent on doing the many things which need attention in the wireless set from time to time but have been postponed through lack of opportunity. Aerials and earths may be overhauled, or if the weather is unsuitable for this work the set itself may receive attention or experiments be undertaken with interference suppressors to get rid of unwanted noises.

We take this opportunity to convey to our readers, both at home and in all parts of the world, our sincere wishes for Christmas and the New Year.

Empire Broadcasting

Growing Importance of the Service

THE approach of Christmas naturally directs our thoughts to the broadcast of His Majesty the King, which is now looked forward to as an annual event. Only through Empire Broadcasting has the forging of this link throughout the Empire been made possible, and the importance of the Empire service grows steadily as its efficiency is improved by the efforts of B.B.C. engineers and organisers.

It is interesting to recall that early in 1926 the proposals put forward by *The Wireless World* that an Empire Broadcasting station should be set up received only discouragement from the B.B.C., who took the view that nothing should be done until a reliable service could be guaranteed. If such a policy had been allowed to stand we should probably still be waiting for Empire Broadcasting to-day, since even those who have been responsible for building up the organisation, an account of which we publish in this issue, would not yet claim to have achieved such results, in spite of the tremendous importance of the service they now direct. We have only to consider for a moment how we should feel to-day if no Empire station had been established to realise how important the service is both now and potentially.

Empire Broadcasting

The Truth about the-

By E. C. THOMSON

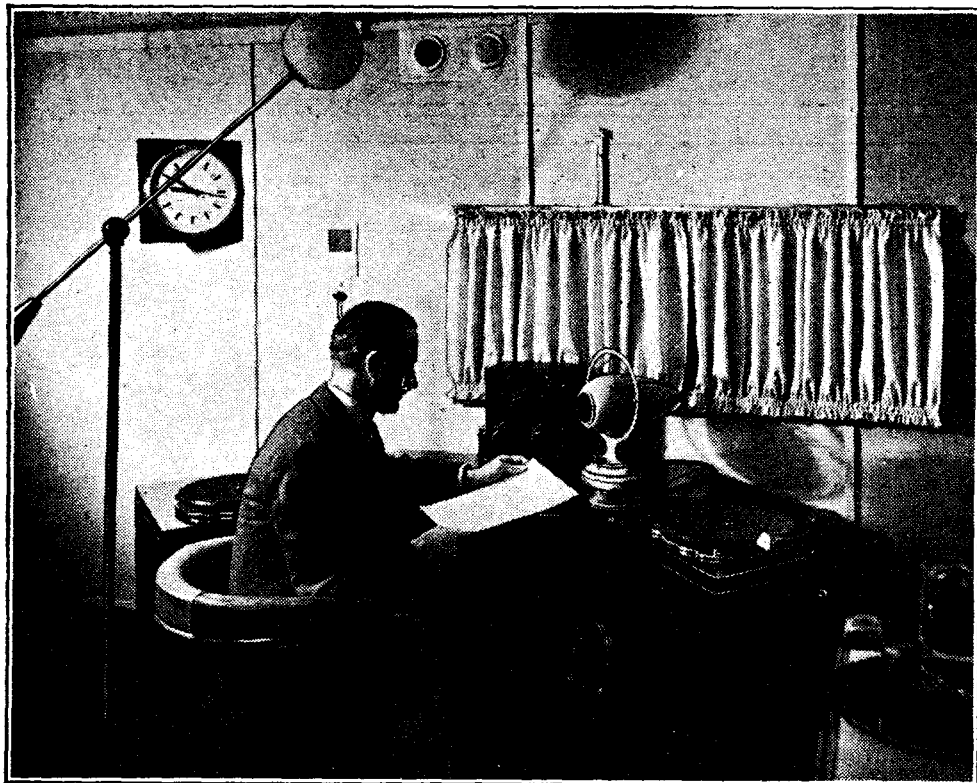

The Empire announcer "eats and sleeps at Broadcasting House—lives there, in fact, for five or six days a week." A picture taken during the reading of a news bulletin.

IF travel broadens the mind it also gives people the courage of their convictions. At least, this is the inference to be drawn from a study of the B.B.C.'s Empire post bag. And when the travellers (or sons of travellers) break into print this downright, straight-from-the-shoulder attitude sometimes grieves the B.B.C.

Matters came to a head one black Friday in July last when *The Wireless World* published an article* by a resident in Singapore who stigmatised the Empire programmes as being "of a low standard and unworthy of British broadcasting." It was clear, he added, that the funds for the provision of "live" programme material "must be very limited" and that "most of the efforts of the Empire programme Department are valiant attempts to make bricks without straw."

The Empire Department bridled at this, not because it is a sin to be poor, but because, having a certain amount of straw, they resented the imputation that the bricks lacked that commodity.

Agitated, they invited me to visit the "brickworks," take notes, and give *Wireless World* readers an unvarnished account of what I saw.

From the outset it was obvious that, to impart all the facts it would be necessary for me to travel from China to Peru—at the B.B.C.'s expense—for it is no

* "This Empire Broadcasting," *The Wireless World*, July 26th, 1935, p. 82.

more possible to judge the final effect of an Empire programme by sitting in the studio than it is to appraise a modern painting with a high-power microscope. "Does Broadcasting Serve the Empire?" then, would have been the title of this article, and on an even grander scale than Mr. Leslie Baily I should have scoured the globe, visiting the mud huts of the Malayan Archipelago and drinking tea in the pavilions of the maharajahs, seeking all the time a civil answer to a civil question. But it was not to be.

I could still, however, enjoy a "close-up" of the machine at work and thus determine in broad outline whether, in my opinion, the B.B.C. was setting about this business of Empire broadcasting in the right manner, so I accepted the invitation to Broadcasting House.

An Empire Tourist

I was welcomed by Mr. Malcolm Frost, who will be remembered as the B.B.C.'s "Ambassador of Empire"; three years ago he toured the world on a special mission, distributing programme records and establishing liaisons between the Corporation and broadcasting organisations overseas. As one of the small squad of B.B.C. men who have actually shared life with Empire listeners, Mr. Frost should know just what is wanted in each of the six zones. ("Zones," by the way, is a forbidden word nowadays, as I shall

explain later, but there is no adequate synonym.)

In company with Mr. Frost I was able to apply the stethoscope to the whole pulsing Empire organism, examining the programmes from day to day, touring the studios and watching the staff at work.

As a High Court Judge might put it, "What is Empire Broadcasting?"

The service now run by that self-contained Empire Department at Broadcasting House has a definite aim, which is to provide every part of the Empire with an evening programme daily. It is important to grasp this aim clearly, otherwise we may find ourselves reproaching the B.B.C. for failing to do that which it never set out to do.

Strait-Jackets for Short Waves

To realise this evening programme ideal the B.B.C. divides the 24-hour day into six sections, or Transmissions, each of which is intended, in some degree, to satisfy a particular portion of the British Empire. Actually there is a considerable amount of overlap, hence the discontinuance of the old "Zone" idea, which worked out admirably on paper but failed to take into account the vagaries of the short waves. It was found, for example, that the entertainment intended for South African listeners during the long balmy evenings in Johannesburg was being audaciously picked up by Western Canadians at breakfast.

This seemed an unpardonable liberty, until even the official "card index" minds came to realise that Hertzian waves could escape from the strait-jacket of the Zone system, and that all time-tables would have to be fairly elastic. Nowadays, frequent changes are made in the transmitting arrangements at Daventry, the object being to provide maximum reception in the countries for which each transmission is primarily intended. A table of call signs, directions and times throughout the year is given on page 581, but Empire listeners are warned that the times are likely to change and that it is advisable to listen carefully to the announcements.

Normally there are two simultaneous transmissions from Daventry, any two of the following waves being available.—

GSA	..	49.59 m.	GSG	..	16.86 m.
GSB	..	31.55 m.	GSH	..	13.97 m.
GSC	..	31.32 m.	GSI	..	19.66 m.
GSD	..	25.53 m.	GSI	..	13.93 m.
GSE	..	25.29 m.	GSL	..	49.10 m.
GSF	..	19.82 m.			

From Within

B.B.C.'s Short-wave Service

PRAISE and criticism rain upon the B.B.C. Empire Broadcasting Department from all parts of the world. This article, based on an impartial investigation at Broadcasting House, explains clearly just how the Empire Department is attempting to reconcile the varying interests of listeners all over the world, and how, on the technical side, the transmissions are designed to give maximum signal strength to as large an audience as possible. Interesting facts are given regarding the B.B.C.'s attitude to propaganda in news bulletins.

Of late three wavelengths have sometimes been used at the same time, the old 5 SW transmitter having been brought to Daventry from Chelmsford; this is another indication that the Zone system has been finally jettisoned and that the B.B.C. wishes to satisfy as many listeners as possible. A three-wavelength transmission is especially useful in the case of Africa. Between Kenya and Sierra Leone—the 3,500-mile stretch from east to west of the African Continent—there is a time difference of four hours. Transmission 4 was originally intended to cover the entire Continent, but it is easy to see that three separate beams can give a much more satisfactory service than one or even two.

It has been pleaded by many Empire listeners that the B.B.C.

would do them a service by making the transmissions more directional, i.e., by the use of reflectors producing a more intense beam. Against this idea the B.B.C. brings the argument that it must work for the greatest good for the greatest number. If, for example, reflectors were fitted on all three aerials in the case of Transmission 4, which relays the main National programme to Africa, Canada would suffer, for the waves travel north as well as south, finding their way over the North Pole.

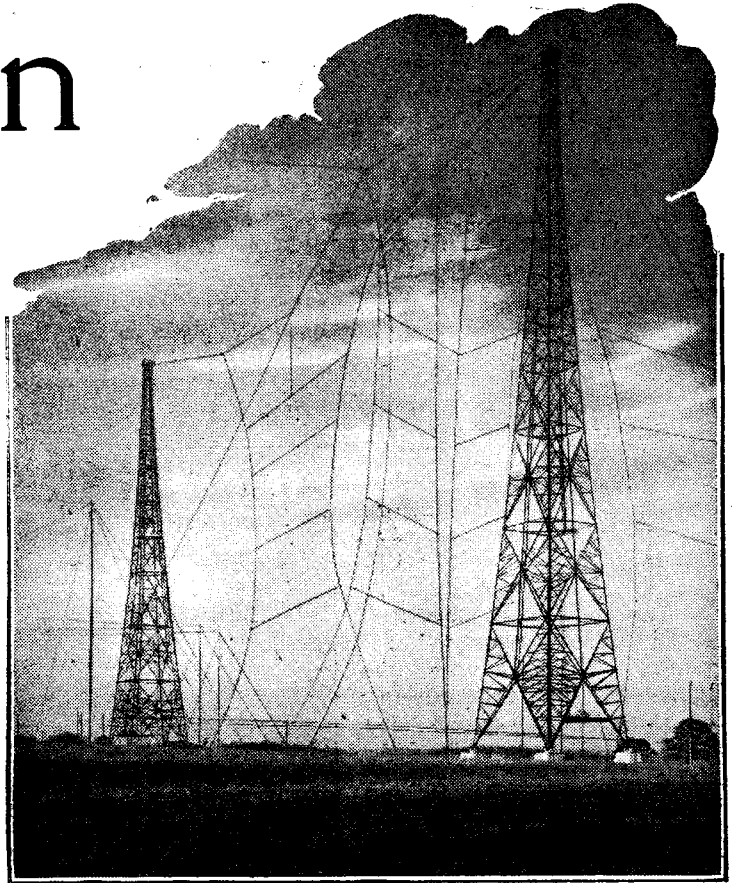

Two 350-ft. towers at Daventry for supporting experimental aerials.

With a third transmitter in use, it is, however, possible to "beam" two of them, leaving the third omni-directional.

The Daventry transmitters are at present using a power of from 10 to 15 kW. When the two new transmitters are put into operation in approximately eighteen months' time, employing a power of 50 kW., a consistently better signal should be available all over the Empire. Nevertheless, on the technical side, the B.B.C. Empire Service has come in for an increasing measure of praise during the past year.

But what of the programmes? Are these being organised in the right way? Or, if obstacles prevent the full realisation of the Programme Department's ideals, is a "bad hand" being played in the best possible manner?

Let us examine a typical day's programmes, working through from Transmissions 1 to 6. All times mentioned will be G.M.T.

The Day Begins

Transmission 1, intended for Australia, New Zealand, the Pacific and Western Canada, begins at 8 a.m. (GSD, 25.53 m.; GSB, 31.55 m.), and the first 30 minutes is usually a "live" broadcast, as distinct from recorded, consisting of variety or a cinema organ recital. Following is an electrically recorded talk from a recent home programme and, at 9 a.m. a "live" performance by the B.B.C. Empire Orchestra, or a small musical combination. News comes at

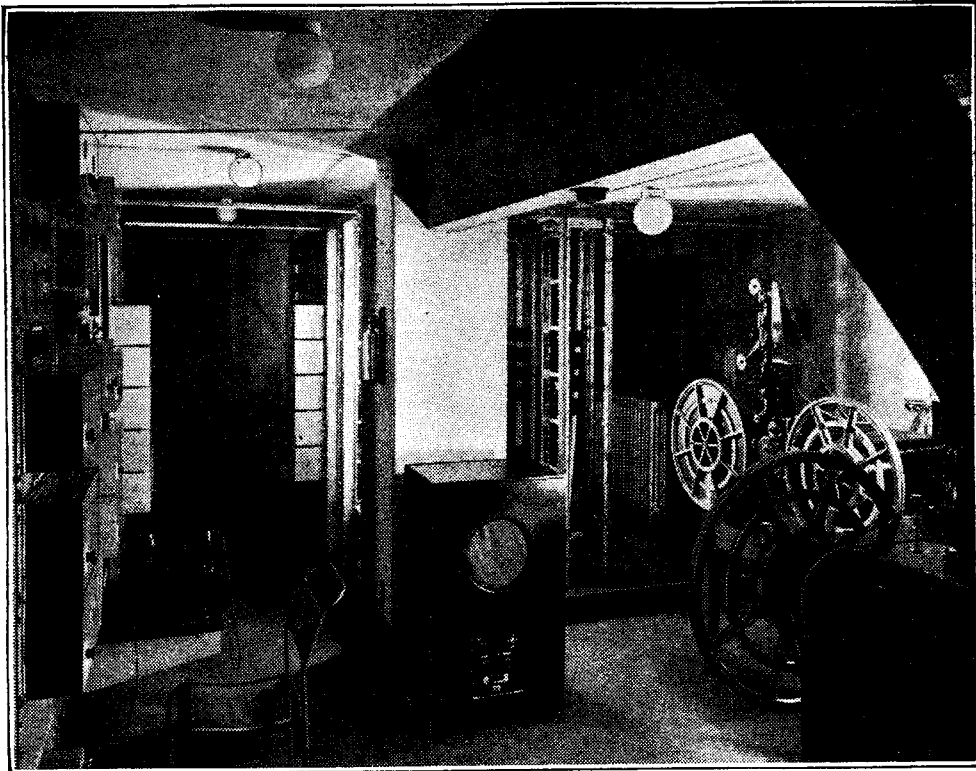

Even recorded programmes cost money; one programme may account for £120 in royalties. This view of No. 1 Steel Tape Recording Room at Maida Vale shows (left to right) tone source and amplifiers, checking loud speaker and two recording machines.

Empire Broadcasting From Within—

9.45, and the close-down is at 10.

Eleven a.m. sees the start of Transmission 2, which is picked up in Western Australia, Malaya, China, and part of India (GSG 16.86 m.; GSF 19.82 m.) A large proportion of this transmission is live, consisting mostly of light music which is being simultaneously radiated in the home programme. At about 12 there is an electrically recorded talk, then more live music, followed by the news at 1 p.m. More light music—orchestral or organ—and the close-down comes at 1.45.

Fifteen minutes later Transmission 3 begins. It is intended for India, Ceylon, and the Near East (GSG, 16.86 m.; GSF, 19.82 m.; GSE, 25.29 m., or GSB, 16.86 m.) Very largely it is made up of the B.B.C. afternoon home programmes, with an occasional tape-recorded talk or variety programme. News is given at 4.30, and the transmission closes down at 5 p.m.

The Best Transmission

The luckiest listeners are those who can tune in Transmission 4, which is mainly a relay of the B.B.C.'s National programme. Part I, from 5.15 to 8.45 p.m., is primarily intended for East and South Africa (GSI, 19.66 m.; GSD, 25.53 m.; GSB, 31.55 m., or GSL, 49.10 m.), and Part II for West Africa (GSC, 31.32 m.; GSB, 31.55 m., and GSA, 49.59 m.). Actually, however, part, or all, of the transmission is picked up at varying strengths in the West Indies and South America, Canada and Northern Australia. The few recorded items are mostly musical interludes. Part II of Transmission 4 closes down at 10.45.

We are now entering the night watches. Big Ben at 11 p.m. announces the start of Transmission 5, which is aimed at Canada, the West Indies, and the American Continent (GSC, 31.32 m.; GSB, 31.55 m.; or GSL, 49.10 m.) On Sundays an entire church service, tape recorded, lasts from 11 to 11.45 p.m.; on weekdays there is live music by a light orchestra. Sometimes a speaker can be induced to give an actual talk at this hour; Sir Walford Davies discussed "Music and the Ordinary Listener" at 11.10 p.m., on November 18th last. After midnight a devoted cinema organist may tickle the keys for half an hour, but usually it is necessary to fall back on electrical recordings of variety or feature programmes. News and announcements are given at 12.45 a.m., and the close-down comes at 1.5.

Now follows the real test of a 24-hour

service—the provision of a bright programme between 3 and 4 a.m. Transmission 6, which was recently added to fill a gap in Western Canada, at present occupies the shortest period of all the Empire programmes, although I understand that it may shortly be extended. (GSD, 25.53 m.; GSC, 31.32 m., or GSL, 49.10 m.) A great effort is made to include at least 50 per cent. of live material, and this is usually supplied by the B.B.C. Empire Orchestra, a string quartet, a dance band, or two or three soloists. Sometimes there is an actuality broadcast (recorded) from some place of interest, such as a railway station or a dockyard.

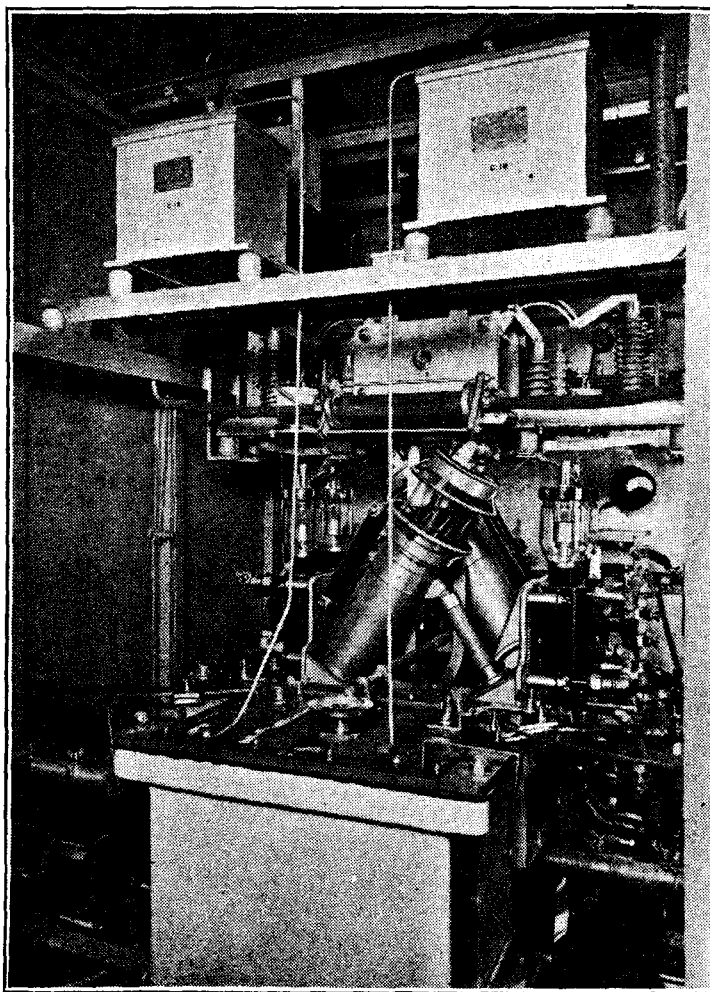

A rear view of the inside of a Power Output stage at the Daventry short-wave station.

News is given at 3.45 a.m., and the transmission closes at 4.5.

Daventry is now silent until Transmission 1 begins at 8 a.m.

The B.B.C. calls this a day.

No one pretends that the service is perfect. Many listeners still kick at the notion of recorded programmes, though they may find some consolation in the fact that these, too, cost money. If a home variety programme involves an expenditure of £500, copyright fees may account for £120, and these must be paid whether the transmission is live or recorded. An important argument in favour of recorded versions is that many home programmes are too long for Empire radiation. Plays especially call

for sustained and concentrated listening, which is often made impossible by atmospheric conditions on the short waves. In such cases good, "snappy" recordings of variety are much to be preferred.

The actual percentage of recorded items is surprisingly small. In a typical day of 19 hours' transmission, only 3 hours and ten minutes consisted of disc or tape records.

The Ullswater Report will doubtlessly recommend the apportionment of a larger sum for Empire Broadcasting, but in the meantime the financial side is a very serious problem to the Department, which has many more hours to fill than the home programme organisation, yet has considerably less money with which to do it. Incidentally most artists demand a higher fee for broadcasting in the small hours of the morning. Home programmes cost £915,000 in 1934, or £2,500 a day—a figure far beyond the wildest dreams of Mr. J. B. Clark, the new Empire Service Director, who discussed his problems with me on the day he took office.

The "Chief" Speaks

"We have been greatly helped," he told me, "by the 45,000 letters which have come to us from listeners. These have enabled us to discriminate between the needs of different parts of the Empire.

Mr. Clark was amused at the idea that he and his staff resent criticism.

"We want it!" he declared. "We welcome suggestions, though there are some that simply can't be complied with. People ask us to give them Dr. Boulton and the B.B.C. Symphony Orchestra in Transmission 5 and 6. Obviously, we can't bring such a 'turn' to the microphone at 3 in the morning. The nearest we get to broadcasting the Symphony Orches-

tra at awkward hours is to relay a final rehearsal in Transmission II. Don't forget, though, that the Regional orchestras are often called upon for 'live' programmes."

I asked Mr. Clark if we might expect big developments in the Empire Service in the near future.

He smiled enigmatically.

"There will be nothing catastrophic," he replied. "We look upon the Empire Service as a complete structure. It is already formed, and what changes come about, will be in the nature of gradual additions to the programmes and improvements in the transmitters.

"In fact, the next landmark will be the opening of the new transmitters at Daventry."

Empire Broadcasting From Within—

There is one very important respect in which Empire broadcasting differs from the home variety. It is competitive, and the staff should avoid any tendency to ignore this fact. While the home stations have a virtual monopoly in their own territory, the Empire transmitters compete for listeners' attention on equal terms with the highly developed short-wave systems of other countries. They must hold their own with the spate of news, propaganda and entertainment radiated from Germany, Holland, France, Italy, Russia—all countries, in fact, which have nothing to lose and everything to gain from making the world continually conscious of their existence.

News—Not Propaganda

The B.B.C. casts no aspersions when it declares that the sole aim of its own Empire news service is accuracy, with a rigorous exclusion of all propaganda. An Empire News Section has been created which selects items likely to interest particular portions of the Empire. For instance, ice hockey commentaries are included in Transmission 5 for the benefit of Canadians; the latest rubber prices are never omitted from Transmission 2, for the Malay States.

Apart from this sub-editing, however, the news is radiated from Daventry without fear or favour, and comment occurs only in running commentaries on sport, never in connection with politics or ticklish questions affecting international relations. All news is in English.

One serious criticism on the technical side may be met by the opening of the new transmitters. Listeners all over the world write to Broadcasting House complaining that the Dutch, German or French transmissions "romp in" at much better strength than the British. It is significant that these complaints come first from one area and then from another—never from all parts simultaneously. The B.B.C. contention is that such wonderful reception of the foreign transmissions is spasmodic, whereas their own transmitters give the best consistently good signal strength all the year round. This is a proud claim which I, personally, am not prepared to substantiate. The question could only be decided by a world plebiscite, perhaps conducted by the International Broadcasting Union.

The B.B.C. certainly have a good case when attacked on the score that their transmissions are lamentably inferior to the Dutch. By a happy dispensation of providence, our friends in Holland are able to use the same beam to cover both the West and the East Indies. Into this beam they can concentrate tremendous signal strength. Perhaps it is not unnatural that British listeners living at points within this beam should draw odious comparisons, but is it fair?

What impresses the visitor to the Empire Department at Broadcasting House is the keenness of every member of the staff. They look upon this business

Transmission.	Optimum Direction.	Times (G.M.T.).
1 GSF GSB	East and West " "	Nov. 10th to Dec. 14th .. 08.00—10.00 Dec. 15th to Jan. 18th .. 08.30—10.30 Jan. 19th to Feb. 15th .. 08.00—10.00
2 GSG GSF	East and West " "	11.00—13.45 (Sundays 12.00—13.45)
3 GSF GSE GSB	East and West " " " "	14.00—15.15 14.00—17.00 15.30—17.00
4a GSD GSB GSI GSL	North and South " " " " North-West and South-East	17.15—21.00 19.15—21.00 Experimental only 17.15—19.15 " " 19.30—21.00
4b GSC GSB	East and West North and South	21.15—22.45
5 GSA GSC	North-West and South-East East and West	23.00—01.00
6 GSC GSL	North-West and South-East " " " "	03.00—04.00

of linking the Empire with the Homeland as an exalted mission, and such it is. For this reason, every Empire broadcaster has been specially picked for his job.

I sat in a tiny box-like studio beside a young announcer who was quietly introducing Reginald New and his organ to listeners in the Malay States. Like his colleagues, this announcer had been chosen for his rather high-pitched voice,

which, so listeners say, pierces the atmospherics more successfully than the heavy and fatherly tones of the home announcers. Like his colleagues, this announcer eats and sleeps at Broadcasting House—lives there, in fact, for five or six days a week—and gets four or five weeks' holiday a year to tone up his nervous system. He needs it.

It is a job on which the sun never sets.

At the Transmitting End

Technical Criticisms of Recent Broadcasts

One can harp on this Balance theme *ad infinitum*, apparently. There seems to be no real control over most of the broadcast material after it leaves the studio microphones, so that if we do get a nicely balanced programme—as is sometimes the case—it is largely a matter of luck, and, conversely, the following evening's listening

involved in the making of a picture from a photographic negative and warrants just as much care. The way in which it is done is, of course, unimportant, so long as it is done; one sure way being to make the producer the final control link in the microphone-aerial chain so that he has complete control over the outgoing programme and can adjust the aural perspective within fairly wide limits.

These remarks are inspired by the Gala Variety (London Regional, November 23rd), in which some correction could have been

usefully employed in giving both Tessa Dean and the two pianists, Rawicz and Landauer, the prominence above the accompaniment which should have been theirs.

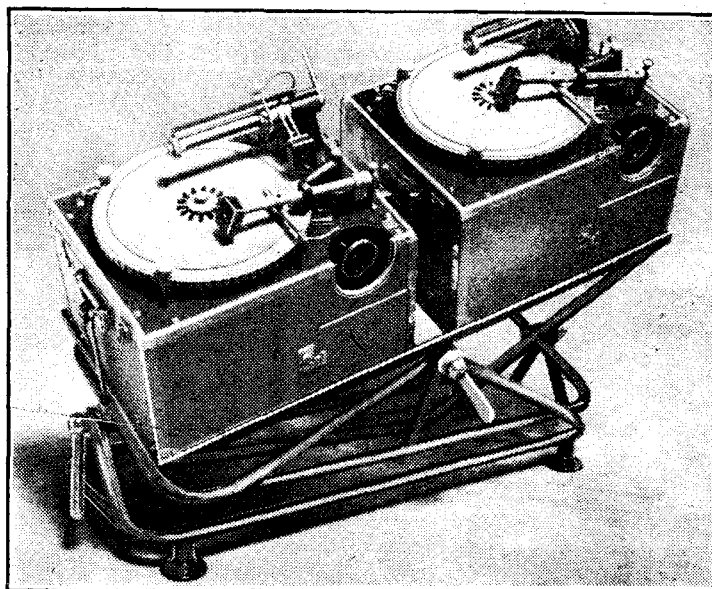

Engineers at Radio-Geneve have devised this "cradle" to enable them to make records when the recording van is standing on a slope.

is just as likely to be exasperating in the extreme.

It is no exaggeration to say that the putting over of any programme in this respect is every bit as important as the processes

The latter artists, in particular, did not get over at all well, for, compared with the announcer's hearty voice, the two pianos sounded as vigorous as an anæmic ukelele.
H. C. H.



Suggestions for the Holiday Season

ALTHOUGH it is too early to talk of New Year resolutions, the Christmas holidays offer an excellent opportunity of making amends for some of our sins of omission. The natural tendency to put off until to-morrow those jobs which are non-essential is every bit as pronounced with regard to our wireless activities as in other spheres; now is the time, of all others, to put into effect those alterations and additions which have often been considered, but always postponed, and which will do so much to increase the pleasure to be derived from a good receiver.

Even the most critical and knowledgeable of wireless users seem to be surprisingly tolerant—or apathetic, or procrastinating?—in their outlook on electrical interference. They know—or if they do not it is through no fault of *The Wireless World*—that it is only in very rare cases that background noises cannot be reduced to a very acceptable extent; more often than not, interference can be rendered entirely innocuous, so far as received signals of any real programme value are concerned. But all who have special opportunities for getting inside information on the conditions under which reception is carried out will agree that it is still a rare experience to find any kind of interference suppressor in use. This in spite of the fact that those well qualified to express an opinion are agreed that the interference

MANY of us can count on a holiday of three or four days at Christmas time. Traditionally, this holiday is spent at home, and how better can the time be used than in improving our facilities for broadcast reception? Further, on the natural assumption that one's wirelessly-minded friends will be of the same mind, the wherewithal to carry out the alterations and additions suggested in this article would surely make acceptable presents

level is high enough to prejudice long-distance reception in about 30 per cent. of the homes with an electric supply.

What is to be done about it? Of all the cures open to the average amateur there is nothing more likely to be productive of the desired results than the simple condenser filter, connected across the incoming mains as close as possible to their point of entry into the building. Most of the interference reaching a receiver installed under ordinary domestic conditions has its source at a considerable distance from the sufferer, and is transferred to his receiver either by radiation from the electrical wiring or by direct injection into the set; trouble from both these sources is satisfactorily overcome by such a filter.

Of course there is no objection to making up one's own filter with a pair of condensers, and, to be on the safe side, a pair of fuses as well. However, it is easier, and generally rather neater, to use one of the ready-

made units, supplied in a bakelite case and with such complete instructions that anyone with the slightest knowledge of electrical practice could hardly fail to fit it properly. A similar condenser filter connected across the mains supply of the set itself is often surprisingly effective, but it can do nothing to stop mains-radiated interference, costs about the same, and is very little easier to fit; it is therefore a device for the very lazy, or where some special conditions exist.

Amateur Sleuths

In those few cases where insufficient improvement is brought about by the methods suggested above, the next step may logically be the fitting of a screened down-lead for the aerial. The method most in favour at the present time calls for matching transformers at each end of the screened line; the effectiveness of commercial components for installations of this kind has greatly increased of late, but it should be emphasised that the user must do his part, and devote careful thought to the positioning of the business (or un-screened) part of the aerial.

Before leaving the subject of interference—which, by the way, is quite a fascinating one, perhaps because it arouses the natural instincts of the chase—it should be pointed out that for the cause of a certain amount of avoidable back-

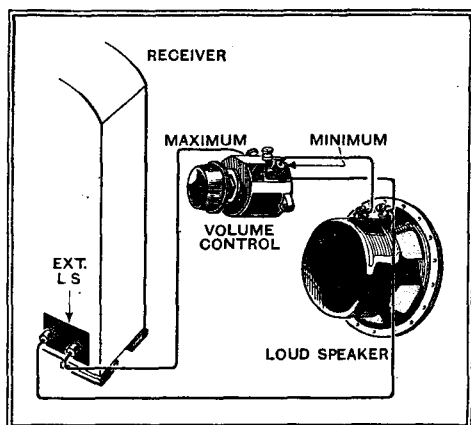

Method of connecting a volume-control potentiometer to an extension speaker.

at Christmastime



ground noise one need look no farther than the domestic electrical wiring. Bad contacts at junction boxes, fuses, switches, and other various appliances can be responsible for a lot of trouble, particularly if the building is near a main road or in any other way subject to vibration.

Before starting work, make sure that the main switch is "off." Incidentally, one needs proper tools for this and other jobs, and it would be wise to lay in a stock; as the mechanical side of our pursuit is completely overshadowed by its electrical aspect, we wireless people are apt to be a bit careless in these matters, and to think that anything can be done well enough with a cheap pair of pliers and a solitary screwdriver. The possession of proper tools removes the excuse for slipshod work.

The question of extension loud speakers can be approached from several angles.



A hint (should there be any spare time for an overhaul): the speaker magnet gap may best be cleaned with the help of vaseline-saturated cotton wool.

The auxiliary reproducer may be regarded as merely of secondary importance, or (more attractively) as a source of better quality reproduction than that included in the set. In view of the natural limitations

existing in the ordinary table model, there is much to be said for adopting this point of view, and installing the best instrument one can afford, in the best (and biggest) baffle or cabinet that can be accommodated.

Wiring Extension Speakers

Practically all sets are fitted with terminals for external speakers, but there is no standardisation in the manner of their connection. Nowadays the majority of receivers (but by a small margin) have the terminals wired across the secondary of the output transformer, which means that the external instrument must be of so-called low resistance (or transformerless) type. The advantages of this plan are that, without any special precautions, the application of HT voltage to the external wiring is avoided, and that the capacity of this wiring will not have any prejudicial effect on quality. It is extremely important, however, that the resistance of the extension speaker leads should be low, and, for long runs, ordinary flex is not really good enough; nothing lighter than "power flex" should be employed.

The speech coil of the external speaker should be of the same resistance as that included in the set.

Extension speakers of the high-resistance type, with built-in transformer, may be connected with light wire, but excessive capacity between the conductors is to be avoided. Precautions to keep HT voltages off the extension lines should always be taken. The questions of coil resistance and matching do not usually arise, as a tapped matching transformer is fitted to most modern speakers.

A volume control at the distant listening point is a desirable refinement, and the method of connecting a controlling potentiometer which overcomes some of the usual objections is shown in the accompanying sketch. For

"high-resistance" speakers fed from a pentode, 50,000 ohms will be about right, while low-resistance instruments will require something in the order of 50 ohms. A more ambitious method of avoiding

frequency distortion was discussed in *The Wireless World* of October 11th, 1935.

Serious work on the receiver can hardly be undertaken without the help of a measuring instrument of some kind, and, so far as mains sets are concerned, a two-range milliammeter is probably the most useful kind to get. On the "high" range, it should be capable of reading the total consumption and also the current taken by the output valve, while the "low" scale should just cover the maximum current taken by any one of the remaining valves. In average circumstances, 0-15 and 0-150 mA. are convenient ranges. It is worth remembering, however, that multi-range instruments nowadays cost little more, and that their usefulness is greatly extended by their voltage and resistance ranges.

The need for a "public address" system (perhaps the expression is rather too pretentious) often arises during the Christmas festivities. The reader may be reminded that every high-output set is a potential public-address amplifier, needing only the addition of a microphone transformer and battery. The only trouble is that the LF portion of the average receiver has barely sufficient amplification to

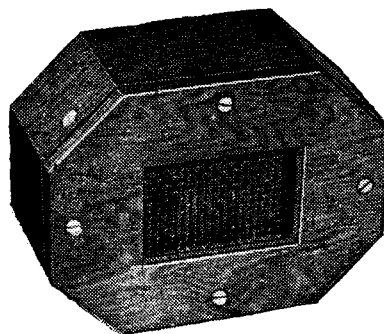

Useful for Christmas festivities: a home-made microphone described in *The Wireless World* of January 11th, 1935.

give full output with most microphones of the better type; when buying one it is wise to make certain of this point, although an extra amplifying stage can usually be improvised quite easily.

There is ample scope for ingenuity in arranging record-playing equipment with the help of the playing desks, record-changers, and improved gramophone pick-ups that are now available. A record storage cabinet should form part of the equipment.

Portable sets may seem out of place at Christmas time, but the latest type of midget or truly portable set is useful all the year round.

Readers who do not know where to obtain the material required for their Christmas activities are reminded that *The Wireless World* Information Bureau is at their service, and that arrangements can be made for catalogues, etc., to be sent by the makers of the gear concerned.

Finally, it should hardly be necessary to remind the reader that the domestic set itself should be in first-class condition for the Christmas broadcasts. There is always the possibility that a spare valve or two, or else an HT battery, will be needed.

CURRENT TOPICS

EVENTS OF THE WEEK IN BRIEF REVIEW

Crystals Again

THE opening of the new high-power stations in France is starting a minor boom in crystal sets.

More Power for U.S.

THE U.S. Federal Communications Commission is holding a conference in March, 1936, in order to plan a "horizontal power increase" by the majority of American broadcasting stations.

Wireless for the Blind

THE Christmas Day broadcast appeal in aid of the British "Wireless for the Blind" Fund will be made this year by Lord Sankey. The Fund aims at providing wireless sets for blind people in Great Britain and Northern Ireland. It was inaugurated in 1929 by the Prince of Wales.

Electrolytic Condensers

A LECTURE on "The Principles on Applications of Electrolytic Condensers" will be given by Mr. Philip R. Coursey, B.Sc., M.I.E.E., at a meeting of the Institution of Electronics to be held on Tuesday next, December 10th, at 7 p.m. at King's College, Strand, London, W.C.2. Invitation cards on written application to the Secretary, 85, Gloucester Place, W.1.

Car Radio Ban ?

AMERICAN set manufacturers are up in arms over a proposed ban upon car radio in St. Louis. An ordinance, sponsored by Major A. J. Lam-

bert, St. Louis' Police Commissioner, would make it unlawful to operate wireless sets on vehicles in public streets, with fines ranging from \$5 to \$500 for violation of the rule.

Mr. Bond Geddes, vice-president of the American R.M.A., declares that car radio is a safety factor on the roads, preventing accidents by keeping drivers more alert and reducing the driving speed.

Last year a similar ordinance was introduced in the Legislature of Connecticut, but was defeated in committee.

Polygot Announcers

FRENCH radio announcers must in future learn the elements of at least four languages, according to an order issued by the P.M.G., M. Mandel. The four languages are English, German, Italian and Spanish.

A Station Clean-up

"HAY-WIRE" broadcasting stations are to be finally banned in America by the Federal Communications Commission. New regulations require that "good engineering practice" shall be observed by all stations, and to this end the Engineering Department of the Federal Communications Commission is to issue periodical specifications.

According to Mr. A. D. Ring, the Commission's assistant chief engineer, investigations have revealed that measures for the protection of life are inadequate at many stations, exposed leads and wires being a constant danger. Many transmitters are almost literally "lashed up."

The new regulations are also designed to ensure maximum efficiency. Stations must not

over- or under-modulate, and an adequate number of meters must be included in the circuits to enable operators to check performance. Other regulations concern the reduction of interference and noise level.



PROFESSIONAL. Miss Natalie Piskor, control room engineer at Warsaw, varies her spells of duty with turns at the microphone.

Signal Officers' Dinner

A GALLIPOLI and E.E.F. Signal Officers' dinner has been arranged, with Major-General Sir Graham Bowman-Manifold, K.B.E., C.B., C.M.G., D.S.O., in the chair, at the Piccadilly Hotel, at 6.30 p.m. for 7 p.m., on Friday, December 13th, 1935. Evening dress, with decorations, will be worn.

A number of the old Signal officers of the Gallipoli and E.E.F. areas have already signified their intention to be present, and it is hoped that as many as possible will attend in order that the dinner may be a real reunion of the Signal officers who served in these campaigns.

Full particulars can be obtained from Major J. J. Munro, Authors' Club, 2, Whitehall Court, S.W.1.

U.S. "Secret" Link With Addis

FOUR U.S. Navy operators are in charge of a portable short-wave station which has been erected in the grounds of the American Legation in Addis Ababa to establish a direct and "secret" link between Wash-

ington and the Abyssinian capital.

Daily contact is maintained for two or three hours during the afternoon, the U.S. receivers being at Arlington and Annapolis. Communications are confined to Government business.

Does Broadcasting Serve Britain ?

MR. LESLIE BAILY's sixth article in the above series will appear in our issue of December 13th. The article will describe the author's journey across Scotland from Glasgow, via Inverness, to Burghead, where the new North Scottish Regional Station is nearing completion.

Cheaper Radio to H.M. Ships

A NEW service of radio telegrams to H.M. ships on foreign stations (except the Mediterranean station) has been introduced by the Post Office, and messages can now be sent via Portishead Radio at an inclusive charge from this country of 7d. per word.

For radiotelegrams to H.M. ships in home waters, via Cleethorpes Radio, the inclusive charge remains at 3d. per word; while the present rates of 6d. and 9d. a word via Rinella Radio and Gibraltar Radio respectively to H.M. ships on the Mediterranean station are also unchanged.

As an alternative to the service via Portishead Radio, radiotelegrams may still be sent via Admiralty coast stations abroad at the present rates. These vary from 1s. 4d. to 3s. a word from this country.

Broadcasting Parliamentary Debates

NEW ZEALAND has taken the plunge. According to an announcement made last week by Mr. M. J. Savage, Leader of the victorious Labour Party, important debates in the House of Representatives are to be broadcast.

It is not stated whether any form of running commentary will be employed to link up the speeches, or even whether a number of microphones will be used, enabling each participating member to remain in his seat while addressing the chair and the world in general. But whatever methods are employed, New Zealand is to be congratulated on having the courage to take a step which has always daunted other nations, not to mention M.P.s themselves.

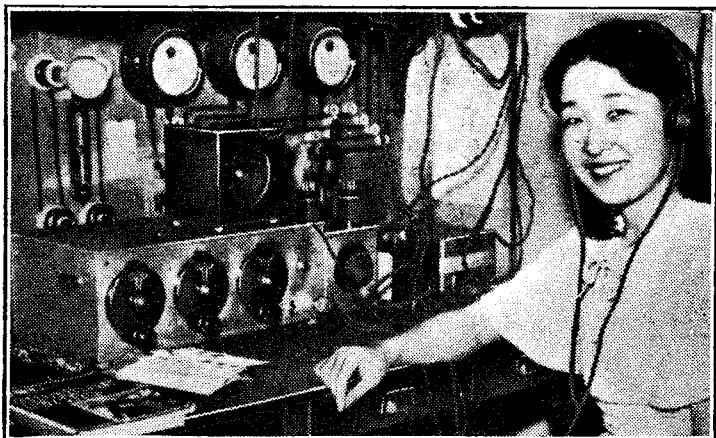

AMATEUR. Miss Chiyono Sugita, who is the only woman radio amateur in Japan, uses this businesslike outfit for regular communication with "hams" in the United States, Australia, China, Russia and the Philippines.

An Introduction to Short Waves

How Best to Receive Broadcast and Amateur Stations

BECAUSE the majority of wireless sets are restricted in their usefulness to receiving over a relatively small band of wavelengths—from 200 to 2,000 metres, to be precise—perhaps it is only natural that many listeners should think there is nothing of real interest to be found outside this band. On the contrary, there are quite as many, if not more, interesting wireless transmissions in that part of the radio spectrum described as the short-wave region, and extending from 10 to about 100 metres.

Within this band are to be found many broadcast stations which, although located in all parts of the world, are easily received in this country; furthermore, elaborate receivers are not essential, and surprisingly good results can be obtained with quite simple and inexpensive sets.

Sandwiched in among commercial and broadcast stations are the wavebands allotted to amateur transmitters, and it may be of some interest to record in passing that it is due largely to their activi-

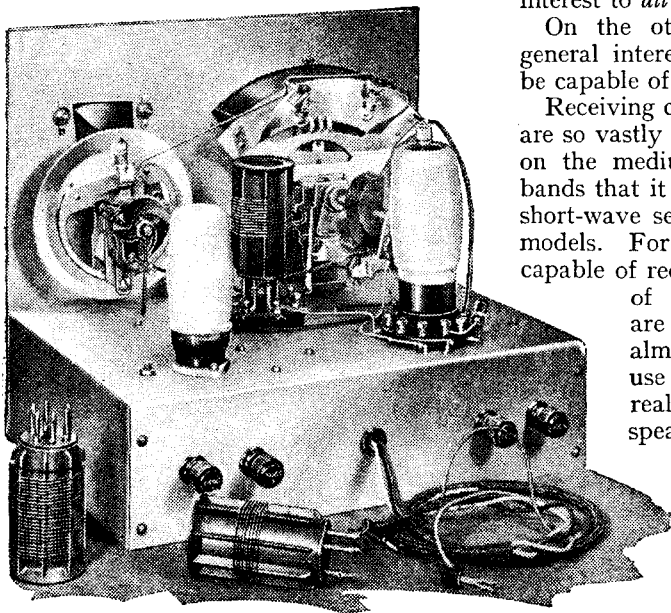

ties in the past that the potentialities of the short waves as a medium for world-wide communication were first made known.

Thus the interest to be derived from short-wave listening might well be considered under two broad headings, viz., broadcasting and amateur activities respectively. Since the majority of amateur stations are now equipped with telephony transmitters, any listener so disposed can easily follow the general trend of their

***T**HERE is no better time of the year to start in on short-wave reception. A short-wave set or components to build one would make a Christmas present of special appeal.*

experiments with any set designed for short-wave broadcast reception. It does not follow, however, that a set designed primarily for the broadcast reception is also the best for use on the amateur wavebands. Very often a headphone set is preferable in the latter case, since it is not unusual for amateur activities to extend far into the night, so precluding the use of a loud speaker to avoid domestic misunderstandings; and, furthermore, these transmissions are not necessarily of interest to *all* members of the household.

On the other hand, broadcast is of general interest, and the receiver should be capable of loud speaker reproduction.

Receiving conditions on the short waves are so vastly different from that obtaining on the medium, or the long, broadcast bands that it is quite impossible to divide short-wave sets into local and long-range models. For even the simplest types are capable of receiving signals from all parts of the world when conditions are favourable, though it would almost certainly be necessary to use headphones. It must be realised, however, that for loud speaker reproduction a far more

A modern short-wave receiver embodying a straight circuit and band-spread tuning described in the "Wireless World" of Nov. 15th last.

powerful set is needed. As a general rule the headphone models are designed on the simplest possible lines, consisting of an aperiodic HF stage, a detector with reaction, and one small power output valve. The more powerful sets are invariably superheterodynes, and it is now not uncommon for these to include all the broadcast wavelengths, being styled all-wave receivers. As a rule broadcast reception on the orthodox wavebands is the primary consideration, but, nevertheless, the short-

wave performance is entirely satisfactory.

The effects of light and darkness on the propagation of the short waves are comparatively well known now, and from the data available radio engineers can ascertain the most suitable wavelength for communication with any part of the world at any period of the day or night.

So far as the ordinary short-wave listeners in this country are concerned, it need only be remembered that in general during the winter evenings it is hardly worth while listening on wavelengths below 20 metres or so after about 6 p.m. For the next two hours good signals may be expected between 20 and 40 metres, while after this wavelengths from 50 metres upwards may be more productive of signals.

The most important factor governing reception from distant countries is the difference in meridian time obtaining throughout the world. It is obviously useless listening for an Australian broadcast station, for example, during the evening, for it will be early morning in the Antipodes, and normally broadcast will not have commenced.

Colonial listeners have their programmes from the Empire stations in this country arranged at the most convenient time for them, and on wavelengths best suited to the conditions.

Amateur experimental transmissions are not definitely restricted to any hours apart from the fact that they are usually more numerous on Sundays, though it is not uncommon to hear European and American amateurs working on the 40- and 20-metre bands on week-days.

Although telephony is used by experimenters whenever possible, many messages are exchanged in the Morse code, so that it behoves the embryo experimenter to lose no time in acquiring a working knowledge of it, and it is a good plan to practise sending as well by keying an LF oscillator and listening to the signals in headphones. Later, when experience has been gained in handling and constructing short-wave apparatus—for much can be learnt by building one's own sets—and in the operating procedure followed by amateurs the world over, the listener should have sufficient confidence in his abilities to undertake original experimental work to justify applying for a transmitting licence.

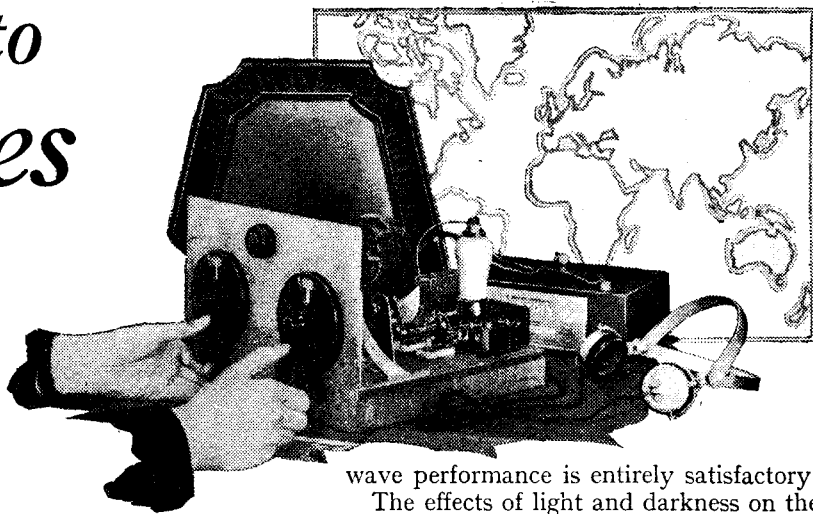

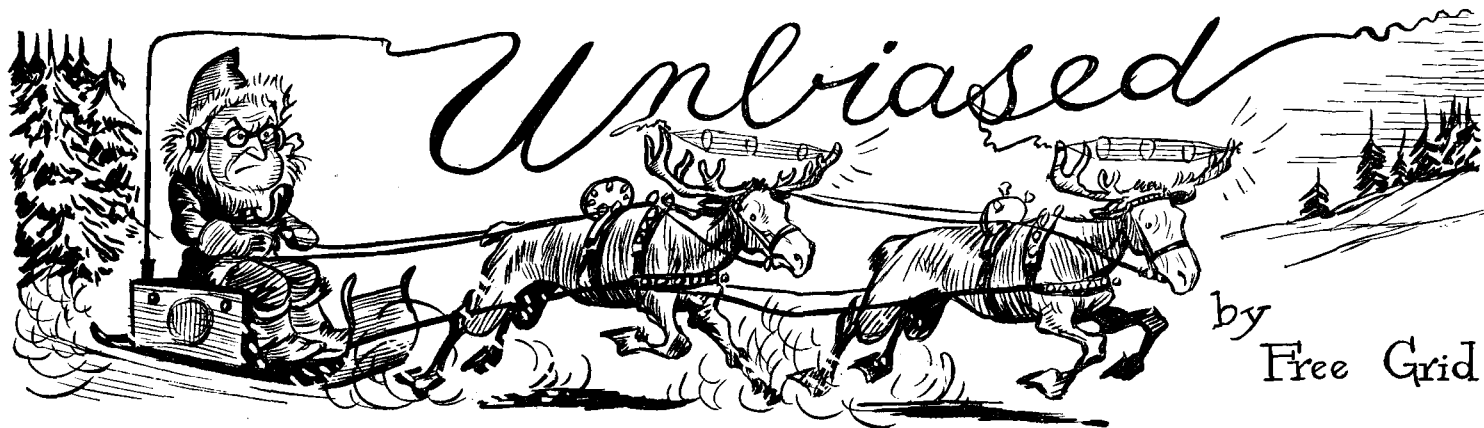

I SUPPOSE that for most of you Christmas is still a matter for glorious anticipation, and that but few of you are, like me, sitting surrounded at this moment by presents galore and all manner of things appertaining to this joyous season. It is, of course, because of my Dutch ancestry that I am thus engaged in premature celebrations, for to-day is St. Nicholas Day, when all good Dutch children—and some that are not so good—get their first taste of Christmas fare.

Fortunately, I have, in addition, some Scottish blood in my veins, having once been the joyful recipient of a pint of the best Scotch blood from a generous donor in the Highlands who offered his services for the transfusion purposes at a time when I was in a very low state after listening to a B.B.C. Chamber concert. Owing, therefore, to the triple nature of my blood, I am able to score over the rest of you in having no fewer than three Christmas celebrations, since, apart from December 6th and 25th, I join all good Scotsmen in the celebration of Hogmanay.

A Backslider

Talking of Scotsmen reminds me of an extremely regrettable occurrence last Christmas when a member of that usually moral and upright race sank so low as to inveigle little children into helping him to find the wherewithal to satisfy his inordinate craving for the national beverage.

Like most of you I had been plagued during the early days of December by hoards of nondescript children who came round chanting the peculiarly melancholy ditties associated with the Christmas season. I had long suspected that these wretched juvenile waits, no less than the importunate Guy-Fawkes-Day mendicants, were not working on their own account, but were really the dupes of some international gang of crooks who lolled back in luxurious ease in their Rolls-Royces, living on the fat of the land secured for them by these unfortunate children just as Fagin did, or attempted to do, in the case of Oliver Twist.

Yuletide Adventures of an Esteemed Contributor

I was more than confirmed in my suspicions by a startling peculiarity which I observed in the singing of these wretched children last Yuletide. I was amazed one evening to hear the full-throated chorus of a great cathedral choir singing the well-known German carol "Stille Nacht" upon my doorstep, and, hastening to my window, I peeped cut through a hole in the curtains, and was simply staggered to find that this tremendous volume of beautiful sound and faultless German pronunciation came from the throats

of a handful of ragged urchins upon the doorstep. I was still more amazed a little later when I observed that the movement of their lips did not synchronise entirely with the words they were singing.

Nevertheless, I was so gratified by the performance that I caused refreshments to be taken out to the children, but even I was scarcely prepared for the discovery that the singing persisted even when they had their mouths full.

My suspicions thoroughly aroused, I made a dive for the nearest child and tore off his apology for an overcoat. It was just as I had thought. Concealed about the person of each child were the component parts of a five-metre receiver, and a special loud speaker with a flat-tish horn which terminated just below their mufflers. They had, of course, an on-and-off switch in their pockets, and it was by the use of this that they cut off the singing while walking from house to house or counting their ill-gotten pennies. Apparently, as in the case of the Army, initiative was not included in their training, so that when they found themselves confronted by unexpected circumstances such as the offer of food, they

had not the gumption to switch off while eating.

Threats of the third degree failed to make them reveal the whereabouts of the gang supplying the music, so I hastily retired to my laboratory and got a very rough bearing with my direction-finder. Grabbing a portable five-metre receiver I went out into the streets to pursue my search, passing numerous other parties of these wretched synthetic waits. By taking several bearings I gradually closed in on my quarry, and at length, after a couple of hours' hard work, espied the transmitter mounted in an old pram in the roadway outside a low-down pub. Through the constantly swinging doorway I perceived a decrepit-looking Scotsman imbibing his national beverage. I had little difficulty in deciding that he was responsible for the whole affair; indeed his features told the tale.

My Own Programme

The carols themselves were being fed to the transmitter *via* a pick-up and an automatic record changer. To my joy I perceived a microphone also, and hastily lifting the pick-up off the record and seizing the mike, I began to provide a programme of my own.

That my efforts were not altogether unsuccessful I speedily had proof, as there was a party of waits on a doorstep a little way up the road. I not not been broadcasting five minutes when the door of the house was flung violently open from

within, and an irate householder commenced a violent assault on the singers' nether regions with the buckle end of a belt. I finally wound up the proceedings by triumphantly wheeling away the transmitter to my laboratory, leaving its rightful owner still engaged in earnest conversation with the barmaid.



Surrounded by presents galore.

Unbiased—

Unfortunately the unexpected possession of a complete five-metre transmitter led to my undoing, since it caused me to put into active operation an old idea of giving the little Grid Leaks and their friends a real he-man television demonstration. This was to be some slight recompense for their disappointment last year, when I was compelled to fall back on a not very convincing synthetic demonstration as a result of my being badly let down by the B.B.C., who failed to give the 30-line transmission which they had promised me.

Television in the Grate

I determined to make myself responsible both for transmission and reception, and to adopt a system developed in my own laboratory.

The reception screen was arranged in the wide, open fireplace of my old Elizabethan dining room; the fire was, of course, first extinguished as I calculated that the emotions which my pictures would arouse in my audience would provide all the heat that was consistent with comfort. My

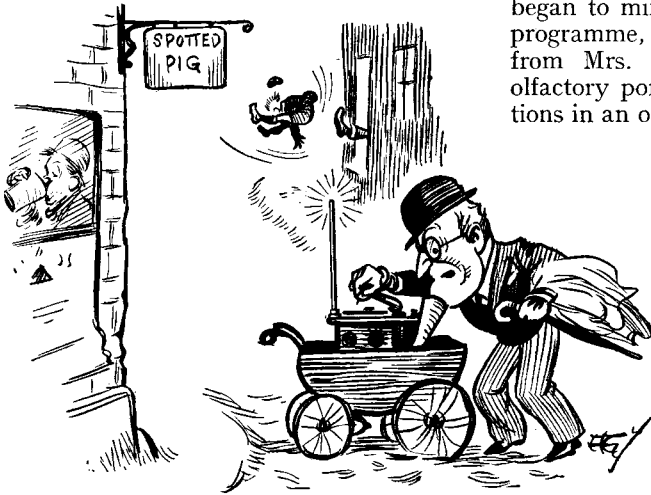

Began to provide a programme of my own.

transmitter was mounted in the fireplace of the adjoining house, which happened to be empty. Using a wavelength of $\frac{1}{1,000,000}$ th metres, I projected my images up the chimney, where they were bent round by means of the double prism arrangement used in high-class field glasses, and so shot down the adjoining chimney-pot, a further right-angled prism directing them on to the back of the receiving screen situated in the fireplace.

In order to make the programme more realistic, I determined to introduce radiolfaction, or to use the language of the vulgar, smellievision. In the fireplace behind the viewing screen I placed a large number of bottles, each containing a different smell in the gaseous state. It was, of course, my intention only to smellievis pleasant smells, just as it was my intention to televise only pleasant scenes, but this did not necessarily mean that each of my bottle gases possessed in itself a pleasant smell. As you are aware

many of the pleasant things of life, such as beer, actually consist of the blending together of highly unpleasant things such as water, malt, etc., and so it is with gases.

The method of releasing any desired gas was borrowed from the experiments in tele-archics conducted by *The Wireless World* in 1926, it being arranged that the release valves fitted to the necks of the various bottles should be operated by ultra-short-waves of various lengths to which the circuits associated with each bottle were respectively tuned.

The days passed by, as they so often do, and eventually Christmas Eve, the chosen day of my party arrived. Having seated my audience comfortably in front of the viewing screen, juveniles in the two front rows and adults at the back, I retired next door to greet the artistes whom I had engaged.

As we warmed to our work I took my place at the control panel and gradually began to mix in the olfactory part of the programme, and, as I learnt afterwards from Mrs. Free Grid, my visual and olfactory portrayals of Christmas celebrations in an old-fashioned country inn were so realistic that several of the male members of the audience grew restless and began anxiously to consult their watches. Smellievision had, in fact, "arrived," and even the all-pervading smell of tangerines emanating from the children in the two front rows was completely overpowered.

All would have gone well had my programme finished five minutes earlier than it did. As it was, the hour of 11 p.m. brought with it the usual stream of cars from the local parking ground. I had, unfortunately, forgotten that the ignition systems of certain cars are strong radiators of ultra-short-waves, and therefore a prolific source of interference to transmissions on those wavelengths.

A Moving Scene

It was unfortunate that the radiation of some of the cars coincided with the resonant frequencies of some of the circuits controlling the release-valves of some of the least desirable of the bottled gases. Soon after the procession of cars commenced passing the house, so I afterwards heard, a feeling of restlessness began to manifest itself among the audience; one or two of the less stalwart, pretending to be overcome by the poignancy of the Dickensian scene I was portraying, hastily left the room with handkerchiefs to their faces, making the excuse that their sobs might disturb the remainder of the

audience. Mrs. Free Grid endeavoured to save the situation by remarking upon the disgraceful pollution of the atmosphere by the petrol fumes of the cars which could be heard passing the house; and thus she

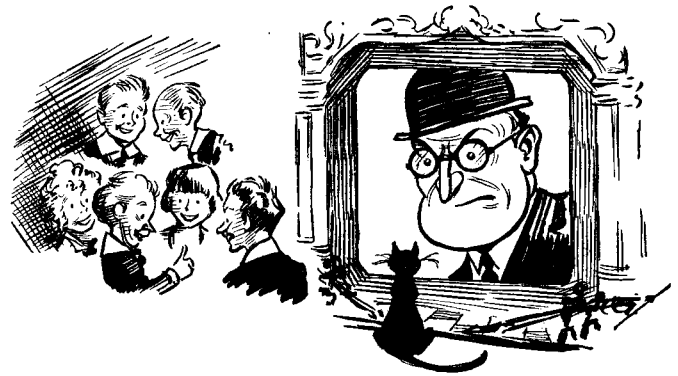

In the fireplace of my old Elizabethan dining room.

all-unwittingly hit the nail on the head. Her presence of mind would probably have saved the situation had I not chosen as my grand finale a portrayal of the arrival of Father Christmas and his reindeer chariot in the old farmyard, and made a great effort to put over the atmosphere of the latter place in an olfactory as well as a psychic sense.

The Last Straw

This was, apparently, the last straw, and the under-current of insubordination and revolt which had been smouldering in the hearts of the little Grid Leaks and their juvenile friends burst into open conflagration. With a yell of execration, the children, thinking that I was behind the screen in person, hurled a volley of tangerines through the screen, thus shattering to fragments all the bottles behind



My grand finale.

it, and thereby, like Æolus, releasing to high heaven the whole of the pent-up gases contained therein.

My attempted explanations were received frigidly, and with muttered comments on the disgraceful state of the drains, my guests departed.



H.M.V. MODEL 370

A "Popular" Radio-gramophone with a "Straight" Receiver Circuit

FEATURES.—*Type.*—All-electric radiogramophone for AC Mains.
Circuit.—Var. mu screen grid HF amplifier—triode grid detector with reaction—pentode out-pul valve. Full-wave valve rectifier. **Controls.**—(1) Tuning. (2) Waverange. (3) Combined radio and gramo. volume control. (4) Sensitivity. (Reaction). (5) On-off switch. **Price.**—16 guineas.
Makers.—The Gramophone Co., Ltd.

been made to fit in with the characteristics of the loud speaker.

The loud speaker itself is interesting, for, although its corrugated diaphragm is small, the energised field magnet is large.

Most of the energy appears to be given off in the middle and upper middle registers, but there is just enough in the bass and extreme top to suggest the full range of musical frequencies and their harmonics. The balance of tone is fixed, and there is no manual tone control. Ample precautions have been taken to suppress hum. There are double hum-bucking coils on the field magnet, and an adjustable hum-control potentiometer is fitted at the back of the set. By these means every trace of mains noise has been eliminated, with the exception of slight modulation hum when the set is tuned to a powerful station which for the moment is not sending any programme.

The chassis is constructed with the customary H.M.V. finish and close attention to detail. The control spindles, for instance, are slotted, so that there can be no question of the knobs working loose after the set has been in service for some

time. The tuning scale is out of the ordinary, and makes use of a disc of light traversed by a shadow line as the tuning pointer. A representative selection of British and European stations is marked on the dial, and it may be mentioned here that in all cases the calibration was found to be accurate.

Simple Circuit

A well-tried type of "straight" circuit has been adopted consisting of the usual arrangement of HF amplifier detector and output valve. A single-tuned circuit is used in the aerial, but close attention has been paid to the design of the aerial coupling to give uniform sensitivity on all wavelengths. An alternative aerial tapping with a high value of series resistance is intended for use close to a powerful station. Subsequent experience with the set suggests that this will not be necessary unless the distance is less than five miles. The HF amplifier, which is of the variable-mu type, has its grid and screen-grid potentials varied by a resistance in the cathode return lead. This constitutes the main volume control, which is supplemented by reaction (sensitivity control)

HITHERTO the radio-gramophones produced by The Gramophone Co. have always been in the "over twenty-guinea" class. These instruments will be continued without price reduction, and the new Model 370 is a special design for those people who are prepared to pay a few guineas more than the cost of a table model radio set in order to have the additional enjoyment of electrical gramophone reproduction. It will be seen from the dimensions of the cabinet, which are approximately 34in. high, 16in. wide, and 14in. deep, that no attempt has been made to make the instrument appear any more than it is, namely, a well-proportioned, if scaled down, example of H.M.V. design. With its figured and straight-grained walnut panels and ebonised legs the cabinet will look well in any surroundings, especially in homes where limited space is available.

Unconventional Layout

That this receiver constitutes a break-away from conventional practice in more directions than one is apparent from the internal layout of the cabinet. To get at the valves, mains voltage adjustment, etc., it is necessary to unscrew and lift the motor board, as the back panel forms an integral part of the cabinet. The loud speaker is attached to the underside of the chassis and passed through a hole in the horizontal platform supporting the chassis into a completely enclosed compartment at the bottom of the cabinet. This expedient overcomes the limitations of the cabinet as a baffle arising from its comparatively small dimensions, but it inevitably raises the question of the possibility of cavity resonance. It is possible to say at once that there is no evidence of this in the reproduction. If it does exist, it has probably

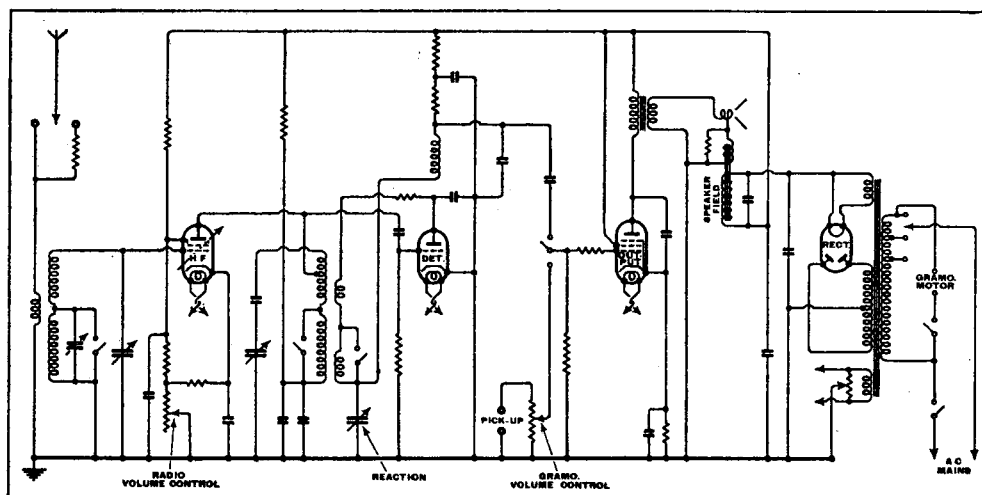

A simple but efficient "straight" three-valve circuit is employed. The radio and gramo. volume controls are ganged and the reaction or sensitivity control is separate.

H.M.V. Model 370—

coupled to the tuned anode circuit. The latter is tapped down to improve selectivity, and the reaction circuit, which is of the throttle-control type, is designed to give uniformity of reaction throughout the wave range.

The coupling between the detector and pentode output valve is resistance-capacity, and a change-over switch in the grid lead enables the output from the gramophone pick-up to be applied directly to the output valve.

The art of obtaining the best performance from the receiver is bound up with the proper manipulation of the volume control on the right and the sensitivity or reaction control on the left. To the uninitiated the provision of two controls apparently producing the same effect when turned up may seem an unnecessary duplication. When their proper function is understood, however, the user should be able to extract a performance which might do credit to many a small super-heterodyne. The principal errors to be avoided are in using too much right-hand volume control and too little reaction, which will result in poor selectivity; or in turning up the left-hand sensitivity control too far and so causing oscillation and distortion. To simplify the process of finding the best setting of controls the designers have hit upon the happy idea of providing a notch in the right-hand volume control at a position which is most favourable for the correct adjustment of the left-hand sensitivity control. The latter having been turned up as far as possible without causing oscillation, the main volume control can then be increased until the requisite volume is obtained.

Range and Selectivity

With the set working under these conditions it was found possible to approach within three channels of the National transmitter and within five channels of the Regional without being inconvenienced by the spread from these stations. In Central London, Fécamp and Cologne are receivable on the medium-wave band in daylight, but, generally speaking, the long waves will have to be relied upon for daytime foreign programmes. After dark,

however, at least twenty medium-wave foreign stations were noted down as of first-class programme value. An aspect of the performance on the medium wave-band which was particularly commendable was the excellent sensitivity at the top end of the range, a point which must always be watched in a receiver of this type.

The gramophone turntable is driven by a silent and solidly made motor. The

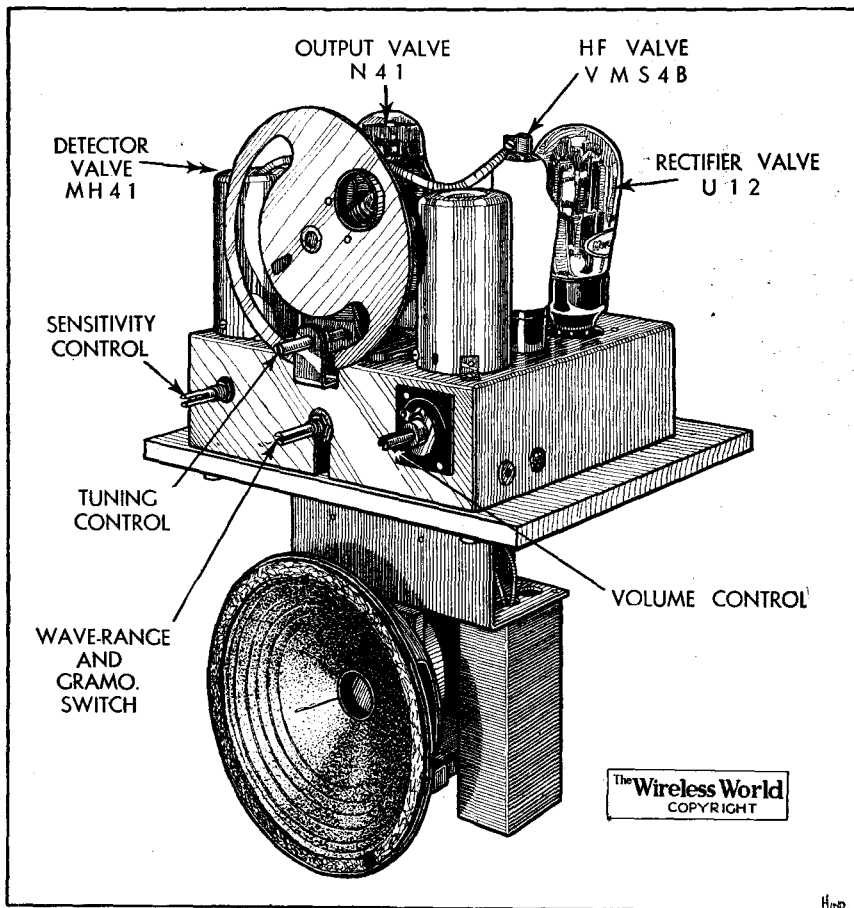

The loud speaker is suspended from the underside of the chassis and occupies a separate compartment of the cabinet. Note the slotted control spindles.

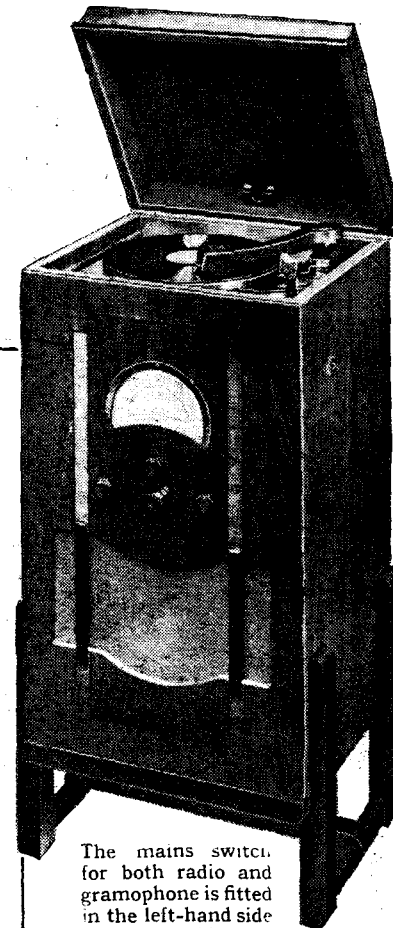

The mains switch for both radio and gramophone is fitted in the left-hand side of the cabinet.

“flock-spraying” process. The pick-up has been specially modified to give an output which is just high enough to feed the output valve of the receiver direct. The pick-up volume control is ganged with the main radio volume control. In a small room it is conceivable that the gramophone control would be required, but the instrument must not be expected to fill a small dance hall as

some of the more expensive sets in the H.M.V. range can do quite comfortably. A special test record is given away with each set, and serves to demonstrate the high standard of modern electrical recordings.

speed is variable, and an automatic brake is fitted which can be put out of action if desired. To minimise the mechanical noise from the needle point, the lid of the cabinet has been lined with sound-absorbing material by what is described as a

Choosing a Milliammeter

Several Ranges Desirable

EVERYONE who takes a serious interest in his receiver needs at least one measuring instrument. For a mains set a milliammeter is admittedly the most useful kind; what current range should be covered?

This sounds simple enough, but actually the matter is hardly one that can be dismissed in a word or two, and it is safe to say that no single-range milliammeter is entirely satisfactory for “vetting” a modern mains set. The guiding principle is simple enough; one chooses an instrument with a maximum scale reading only a little in excess of the maximum current likely to be measured. Unfortunately these currents vary so widely—perhaps from one milliamp.

to over 100 milliamps, in quite a normal receiver—that it is clearly impossible for any single scale to show all values clearly.

We are therefore forced to the conclusion that a multi-range instrument is necessary, and while one is about it it is as well to obtain a three-range instrument; in practice 0-7.5, 0-30, and 0-150 milliamps. seems to be a very satisfactory set of ranges. But, before obtaining an instrument of this type, our readers would be well advised to consider a combination meter, which, in addition to indicating currents, will measure voltages and resistances as well; such an instrument costs very little more and is much more versatile than even a multi-range milliammeter.

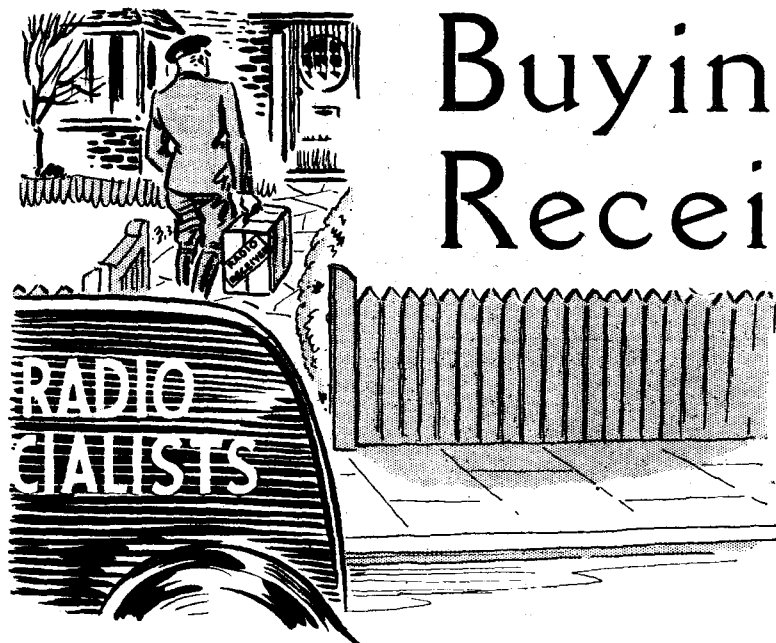

Buying a New Receiver

Hints on Making a Choice

PERHAPS the greatest difficulty which presents itself to anyone who is confronted with the task of choosing a wireless receiver as his own Christmas present is occasioned by the vast number which are now offered for his inspection. He finds it difficult to decide which set to buy, not because of a scarcity of good ones, but because he is bewildered by their numbers. His only hope of obtaining anything approaching his needs, therefore, is to adopt a systematic method of weeding out in order to reduce the number of possibles to a minimum.

Price is usually an important matter, and once a maximum figure has been decided upon a considerable reduction in the number of possible sets has been made. Price is, however, largely bound up with performance and appearance, and there is little point in deciding not to expend more than, say, £10 if what one requires is an all-wave receiver in radio-gramophone form complete with automatic record-changer! Radio-gramophones are naturally more expensive than table models having a similar performance, if only on account of the larger cabinet and the gramophone equipment, and models with an automatic record-changer are more expensive still. It is true that radio-gramophones can be had at the same price as table models, but as one can never get something for nothing it is only reasonable to conclude that they do not give such a good performance on the radio side.

Worth-while Refinements

The vast majority of receivers now offered as table models at prices between £10 and £20 are basically the same, but they are very different in performance, appearance, and ease of handling. Such sets are almost invariably superheterodynes with a degree of sensitivity adequate for good reception of many Continental transmissions with quite a modest aerial,

and they have a degree of selectivity commensurate with their sensitivity. The volume is usually adequate for most domestic purposes and the quality of reproduction, too, is good.

The cheapest receivers can be relied upon to give a standard of performance which would have been considered an unapproachable ideal very few years ago. Higher priced sets may give a better performance or may be virtually the same set in a better cabinet or fitted with refinements, such as a visual tuning indicator. The still more expensive receivers not only have these refinements as a matter of course, but are often considerably more sensitive and selective and give a higher standard of quality. Some models are fitted with variable-selectivity, and this is certainly an important advantage if any stress is placed on the quality of reproduction. Quality and selectivity are mutually conflicting requirements, and one cannot have both to a high degree at the same time. Variable-selectivity thus enables one to obtain the best balance between quality and interference on any and every station. Automatic volume control is another fitting which is very helpful in reducing fading; although it is only of great advantage in distant reception, it is now practically always included in all but the cheapest sets.

The all-wave receiver costs more than its counterpart covering only the medium and long wavebands, but it has a great appeal to those who wish for more than European reception. Signals from all parts of the world can be obtained with such sets, but it must always be remembered that short waves are very variable and one cannot expect the same consistency of reception as on the ordinary broadcast bands. Fading is prevalent and conditions are unreliable, so that although high quality reception at large volume of American stations may often be obtained, the next night programmes from the same station may be unintelligible.

One should not, therefore, choose an

all-wave set if one's chief aim in life is to listen to American broadcasting. No receiver yet made will give *reliable* reception, day after day and night after night, of short-wave signals. If one must listen to Amos an' Andy every day, the only thing to do is to go and live in America.

The chief value to the British listener of the short waves lies in their interest, for one never knows what to expect next. Their very uncertainty can be a source of joy, for whereas the very consistency of medium and long-wave reception tends to make searching the ether a tame business nowadays, this certainly does not apply to the short waves. Hours of careful searching may fail to give anything more exciting than Zeesen, Paris, or Moscow, and then suddenly one may come on Bound Brook, Pittsburg, Rio de Janeiro, Bandoeng, Tokio, or even Sydney.

All-wave, or Medium and Long ?

In the more expensive class of receivers, provision for all-wave reception is gradually becoming a matter of course, but in less expensive sets the number embodying it is comparatively few. One must, therefore, to some extent, choose between all-wave reception or the medium and long wavebands only, with a somewhat better performance over those bands.

Whatever decision one reaches as to the type of receiver, one has eventually to choose a particular make and a particular shop to buy from. These are matters which will not be touched upon here, but it is well always to remember that good firms with a reputation to sustain are likely to prove the most satisfactory in the long run.

TECHNICAL INSTRUCTION

A new prospectus has just been issued by the Technical and Commercial Radio College, Cromwell House, High Holborn, London, W.C.1. Instruction is imparted by correspondence, and the courses are primarily intended for students who wish to qualify for positions in the Service, Testing, or similar technical branches of the broadcast receiver industry. The activities of the College have been endorsed by leading manufacturers.



COSSOR VALVE MANUAL

The B-28 Valve Manual received from A. C. Cossor, Ltd., of Cossor Works, Highbury Grove, London, N.5, is a most useful publication. It contains details of all modern Cossor valves, together with a list of suitable Cossor valves for a very large number of commercial receivers. A section is included containing a number of useful circuit diagrams, and no fewer than twenty-four pages are devoted to brief notes on the different types of valves and their use.

An Unsung Pioneer

A Proposed Television System of a Quarter of a Century Ago

By "CATHODE RAY"



The late A. A. Campbell Swinton, who foretold television developments with almost uncanny accuracy.

SOLOMON would have earned a reputation for wisdom if we had received no other sample from him than the aphorism, "There is no new thing under the sun." The only reason why the mixed benefits of modern civilisation were not enjoyed in past ages is that some part of the material or means for carrying them into effect was wanting. The ideas were always there long before they could be used.

The Iconoscope (the "electrical eye" of the lay Press) has recently been described as "one of those ideas which seem almost too good to be true." It is, of course, a cathode-ray idea, and, therefore, wonderfully up to date, one would think. It is the invention of outstanding interest in one of the two systems of high-definition television which we may enjoy, if we are lucky, some time next year. If we desire a description of how it works we can look up the very recent books and papers on television. Alternatively, of course, we can look up the report of the Presidential Address to the Röntgen Society in 1911.

The chief difference is that, whereas now the Iconoscope is pushed forward prominently as the latest wonder of ultra-modern science, a quarter of a century ago it crept in modestly right at the end of an address dealing mainly with other matters.

A Complete Exposition

You may say, "Oh, yes, the aeroplane—complete with orthodox fatal crash—was revealed in ancient mythology. The steam turbine was demonstrated by Hero of Alexandria about 200 B.C. It is one thing to hit on the general idea, and quite another to work out the scheme in detail." True. All the more remarkable, then, that Mr. A. A. Campbell Swinton should have been able, in a corner of his 1911 address, to give a clearer and more complete account of what is, to all intents and purposes, the present-day Iconoscope than some of the publications on that very subject put forward in 1935.

The only differences between Swinton's proposal and the modern system are minor details as a result of the improvement in electronic technique; for instance, as the

hot cathode had not then been invented it would have been necessary to have used an anode voltage of about 100,000—now we can get what we want with about 2,000.

This does not mean that the modern system is a pure crib. Far from it. The "minor details" of any invention usually present more difficulty than the main principles. There are also problems of television, not peculiar to those making use of the Iconoscope, that Swinton did not tackle—one is the superimposing of synchronising signals on the vision channel. But it is astounding to consider that in 1911 even the triode valve was only in embryo form and practically unobtainable. So Swinton cannot show valve oscillators for line and frame deflection; the deflecting coils are there, as now, but the source of the oscillation is given as an alternating dynamo.

The fundamental difficulty of television is that in reproducing a picture that is not hopelessly coarse (in definition—not subject-matter) it is necessary to transmit

moving image, as in the cinema. The difficulties of dealing with such enormously rapid signal frequencies are largely evaded if one is content with low-definition pictures such as the B.B.C. has ceased to transmit. But Campbell Swinton, with more foresight than many subsequent television pioneers, realised, in the words of the Television Committee's 1935 Report, that "a service of this type would fail to secure the sustained interest of the public generally." He therefore short-circuited low-definition, with its whirling discs and drums, and went straight on to cathode-ray transmitters and receivers for high-definition, as now officially recommended.

His original diagram is reproduced here, and these are a few extracts from his description:—

"D and E are two electro-magnets placed at right angles to one another; which, when energised by alternating current, will deflect the cathode rays in a vertical and in a horizontal direction respectively . . .

"D' and E' are two electro magnets placed at right angles, similar to those in the transmitter, the two magnets D and D' which control the vertical motions of the cathode-ray beam being energised from the same alternating dynamo, F, which has a frequency, say, of 10 complete alternations per second, while the other two magnets E and E' which control the

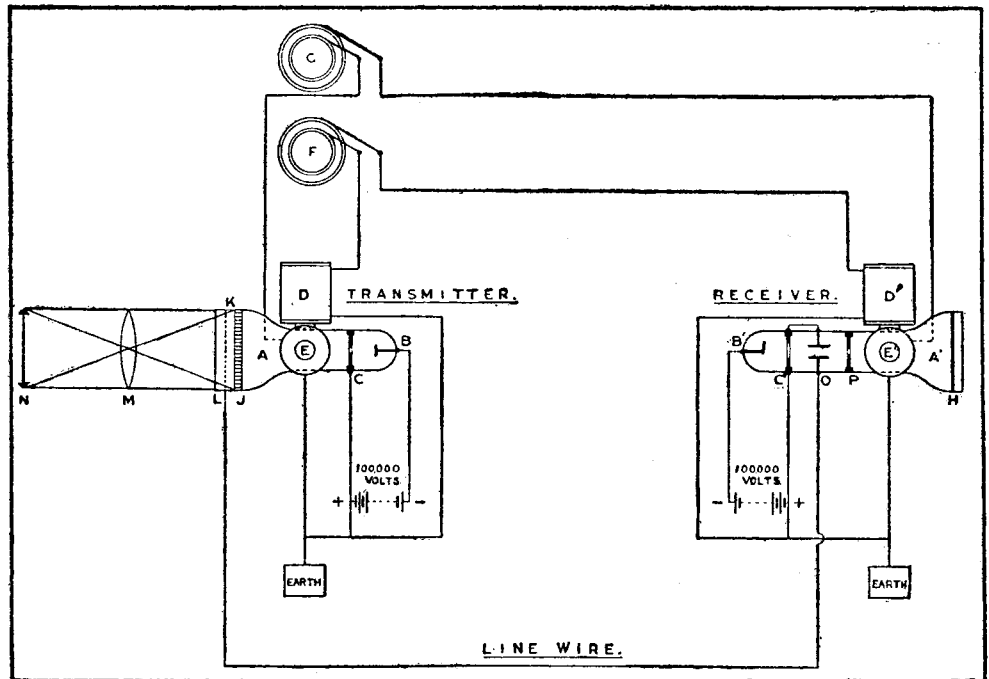

The original diagram shown by Campbell Swinton in his address to the Röntgen Society in 1911. G and F are symbols for any sort of alternating generators (saw-tooth valve oscillators are the present-day type), which, by means of deflecting coils D and E, control the cathode-ray beam emitted from B. The scene N is focused by lens M on the screen J, which is composed of minute photo cells, and the signals are conveyed by line to the receiver, where the ray is deflected over the screen H in unison with that at the transmitter.

thousands of details in a fraction of a second, in order that another picture may follow it in such rapid succession that the eye is deceived into seeing a continuous

horizontal movements of the cathode-ray beam, are energised by a second alternating dynamo G having a frequency of, say, 1,000 complete alternations per

An Unsung Pioneer—

second." (You see he has in mind a 100-line picture—very much better than the late lamented 30-line Baird system, but not so ambitious as the eagerly awaited 240-line Baird system; while his picture frequency of 10 per second is now considered too low to be at all satisfactory. Actually these numbers were chosen more for simplicity of argument than from technical considerations.)

Continuing:—" . . . as the two magnets D and D' and the two magnets E and E' are energised by the same currents, the movements of the two beams of cathode rays will be exactly synchronous and the cathode rays will always fall on the two screens H and J on each corresponding spot simultaneously.

"The screen J . . . is formed of a number of small metallic cubes insulated from one another . . . The metallic cubes which compose J are made of some metal, such as rubidium, which is strongly active photo-electrically in readily discharging negative electricity under the influence of light."

Here is his description of how the system should work:—

"Assume a uniform beam of cathode rays to be passing in the Crookes tubes A and A', and the magnets D and E and D' and E' to be energised with alternating current, as mentioned. Assume, further, that the image that is desired to be transmitted is strongly projected by the lens M through the gauze screen L on to the screen J. Then, as the cathode rays in A oscillate and search out the surface of J they will impart a negative charge in turn to all the metallic cubes of which J is composed. In the case of cubes on which no light is projected, nothing further will happen, the charge dissipating itself in the tube; but in the case of such of those cubes as are brightly illuminated by the projected image, the negative charge imparted to them by the cathode rays will pass away through the ionised gas along the line of the illuminating beam until it reaches the screen L, whence the charge will travel by means of the line wire to the plate O of the receiver. This plate will thereby be charged; will slightly repel the cathode rays in the receiver; will enable these rays to pass through the diaphragm P, and, impinging on the fluorescent screen H, will make a spot of light. This will occur in the case of each metallic cube of the screen J which is illuminated, while each bright spot on the screen H will have relatively exactly the same position as that of the illuminated cube of J. Consequently, as the cathode-ray beam in the transmitter passes over in turn each of the metallic cubes of the screen J, it will indicate by a corresponding bright spot on H whether the cube in J is or is not illuminated, with the result that H, within one-tenth of a second, will be covered with a number of luminous spots exactly corresponding to the luminous image thrown on J by the lens M, to the extent that this image can be reconstructed in a mosaic fashion. By making

the beams of cathode rays very thin, by employing a very large number of very small metallic cubes in the screen J, and by employing a very high rate of alternation in the dynamo G, it is obvious that the luminous spots on H, of which the image is constituted, can be made very small and numerous, with the result that the more these conditions are observed the more distinct and accurate will be the received image."

In other terms—high-definition. All this was written before many engineers now working on television were born!

'It is further to be noted that as each of the metallic cubes in the screen J acts as an independent photo-electric cell, and is only called upon to act once in a tenth of a second, the arrangement has obvious advantages over other arrangements that have been suggested, in which a single photo-electric cell is called upon to produce the many thousands of separate impulses that are required to be transmitted through the line wire per second, a condition which no known form of photo-electric cell will admit of."

This is the crux of the matter. Instead of making a poor photo-electric cell yield perhaps a million harvests a second, it is reaped only 10, or 25, times. Needless to say, the crop is vastly riper. All the time that the other cells are being scanned, each individual is accumulating a nice fat signal; for the light from the scene is acting continuously, not just at the instant when the ray is crossing a cell. When the cell is touched by the scanning ray it yields up the result of its thrift, in the form of an electrical charge, which can be passed on to the distant receiver in one of the known ways of electrical communication.

Soon we shall be seeing the results of this process in our homes. One wishes that Campbell Swinton, who died in 1930, could have done so.

A New Book

Television Really Explained. By P. J. Risdon. Pp. 94. W. Foulsham and Co., Ltd., 10-11, Red Lion Court, London, E.C.4. Price 1s.

THIS is a handy pocket-size volume, treating the subject of television in a particularly simple fashion. The author,

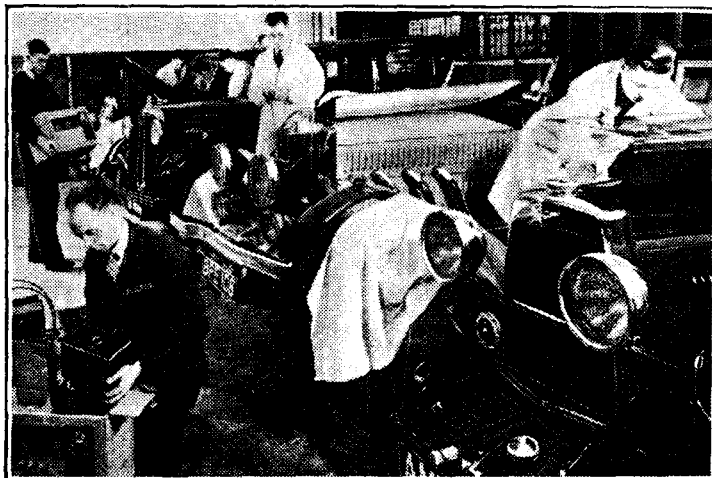

A Marconiphone car radio fitting station has been set up by E.M.I. Service, Ltd., at the Winter Garden Garage, 179, Tottenham Court Road, London, W.1. The installation of Marconiphone car sets in all types of vehicles is undertaken at the new station on behalf of dealers.

CAR RADIO INSTALLATION.—Work in progress at the new Marconiphone fitting station; the mechanics have received training in car electrical practice as well as radio technique.

who has written a number of popular technical books, assumes in his preface that the reader probably has some acquaintance with the rudiments of wireless, such as are contained in his companion volume. He has not rested too heavily on this assumption; on the contrary, he takes trouble to explain even the most elementary principles from the start, so the uninitiated need have no fear of being baulked by technicalities. Added to this, the writer has an entertaining style, with many homely analogies.

Some of the less familiar aspects, such as stereoscopic and colour television and fog penetration are dealt with; and most of the Television Committee's Report is reproduced.

In view of the fact that the book is so up to date as to include reference to interlaced scanning and the Alexandra Palace, one wishes that some of the space occupied by the now defunct 30-line work had been devoted instead to at least an outline of the Farnsworth methods and the Iconoscope. But undoubtedly the novice is put in the position of being able to take advantage of more advanced reading.

M. G. S.

The Radio Industry

UNDER the chairmanship of Captain R. Gambier-Parry, more than fifty employees at the Philco factory, Perivale, have formed their own branch of the British Legion. The new contingent was inspected by Admiral Sir Henry Bruce, K.C.B., M.V.O., Metropolitan Area Chairman of the Legion.

Brown Bros., Ltd., the well-known wholesale firm, are opening a new branch at 671, Christchurch Road, Boscombe.

An informative leaflet, just issued by Voigt Patents, Ltd., The Courts, Silverdale, London, S.E.26, describes the Voigt Domestic Reflector loud speaker from both the theoretical and practical points of view.

Reproducers and Amplifiers, Ltd., of Frederick Street, Wolverhampton, have now issued a leaflet describing R and A Sound Projection Equipment. A feature of the apparatus is that a handy directional adjustment for the loud speakers is provided.

Change of address: British Television Supplies, Ltd., to Faraday House, 8-10, Charing Cross Road, London, W.C.2. Telephone number: Temple Bar 0134.

The biennial dinner and dance given by the directors of the Ever Ready Co., Ltd., to the staff of the company took place recently. Mr. Magnus Goodfellow presided, and the function was attended by 340 people.

An Ideal Christmas Gift

Small Superhet Receiver for the Home Constructor

stations and low selectivity and high fidelity for local reception are instantly available.

The receiver is completely AC-operated and free from mains hum. The whole apparatus can be built for about £12, including valves, cabinet, and loud speaker, and it consequently affords an ideal Christmas present, for not only is it inexpensive, but it is simple to construct and to adjust and its performance is outstanding. Provision is made for the use of a gramophone pick-up, and electrical reproduction of gramophone records is easily secured by adding a pick-up to the mechanical gramophone. Alternatively, the chassis and loud speaker can form the basis of an excellent radio-gramophone by the simple expedient of housing them together with the pick-up and turntable in a suitable form of cabinet.

Some weeks have elapsed since constructional details of the receiver appeared and there should

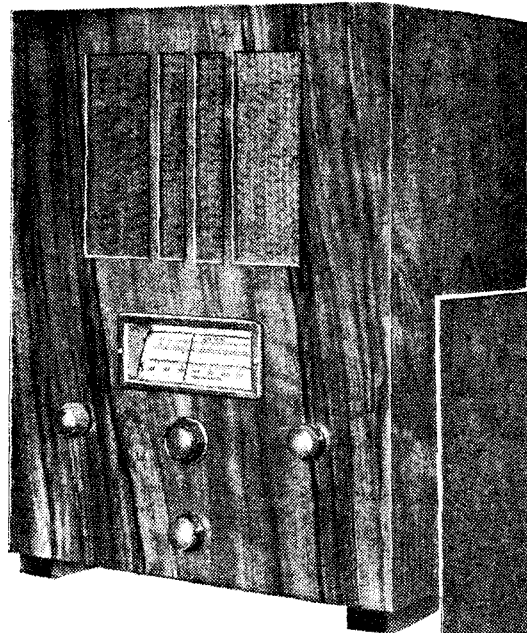

THE VARIABLE-SELECTIVITY FOUR

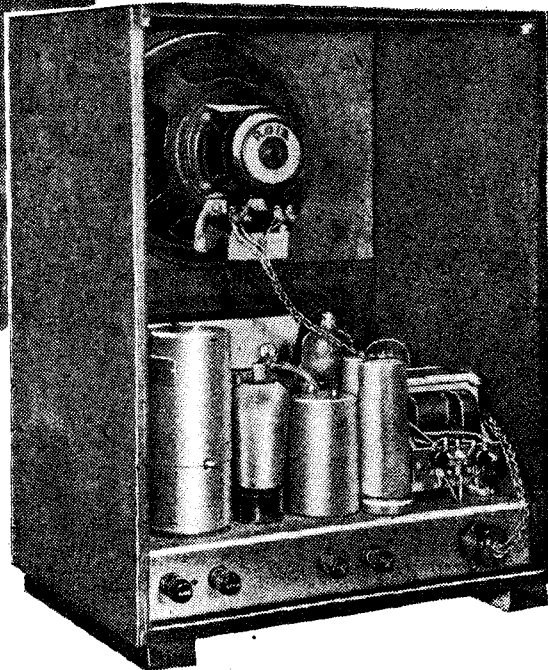

THE small superheterodyne represents one of the most useful receivers available to-day, for it is inexpensive, and when correctly designed it gives a very satisfying performance. This is not always realised, and in some quarters the impression may still persist that such a receiver is incapable of giving good results—an impression brought about by early attempts at limiting the number of valves employed. The position to-day is that a superheterodyne embodying no more than three multiple valves in receiving positions will give all the sensitivity and selectivity needed for general reception; it will provide a standard of reproduction, moreover, which can be excelled only by really elaborate equipment, and an automatic volume control system which truly functions.

The Circuit Details

Constructors of the Variable-Selectivity IV, which was described in *The Wireless World* for November 1st and 8th, 1935, have not been slow to realise its merits nor to appreciate its unique features—features which have made it outstanding in its class. The three valves are arranged as a triode-hexode frequency-changer, an HF pentode IF stage, and a duo-diode-output pentode which not only provides a large output, but gives detection and delayed AVC. A fourth valve is not in the receiving chain, but provides the HT supply. Only one signal-frequency tuned circuit is used, but in conjunction with a special aerial coupling system which enables high efficiency to be secured with freedom from second-channel interference.

Four IF tuned circuits are employed, however, to give the necessary adjacent channel selectivity, and one of the IF transformers is of the variable-selectivity type. To a large extent, this is the secret of the high standard of reproduction obtainable. Normally, high selectivity necessarily means that quality has been

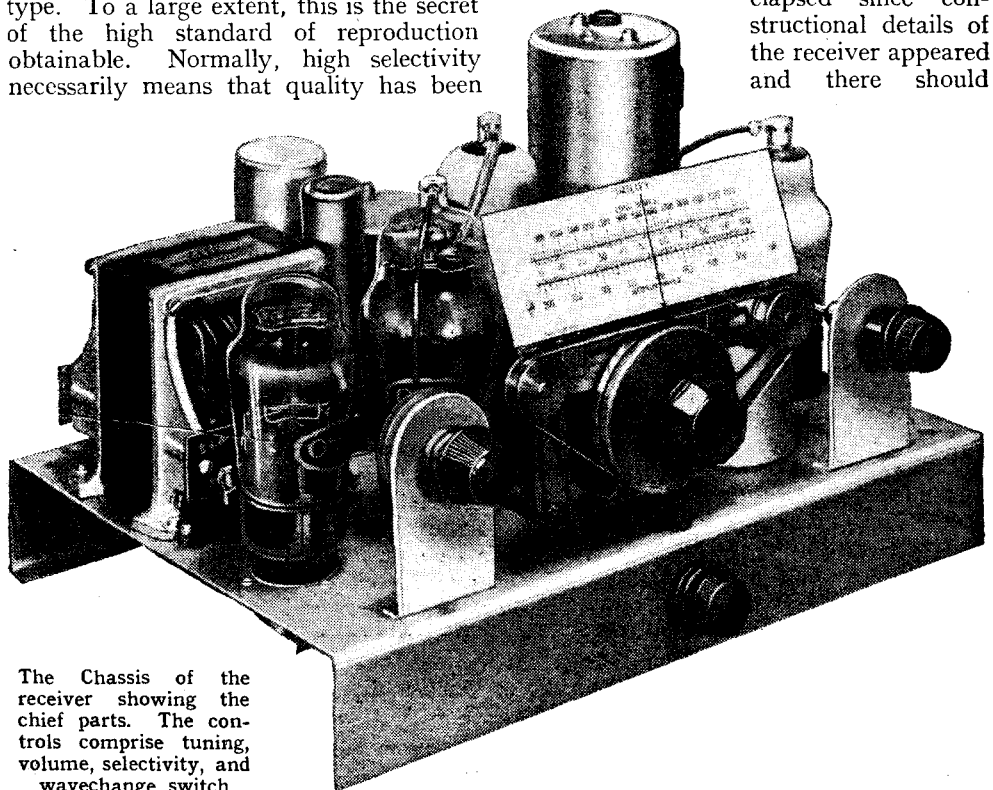

The Chassis of the receiver showing the chief parts. The controls comprise tuning, volume, selectivity, and wavechange switch

sacrificed, but when the selectivity can be controlled at will by the user, it is always possible to obtain the best reproduction that the interference conditions will permit. High selectivity for distant

consequently be no delay in obtaining parts. A full-size blueprint is available at the price of 1s. 6d., and the construction is so readily carried out that it is perfectly feasible to complete the set in time for the Christmas holiday.



EDGAR WALLACE'S GREATEST THRILLER

"ON the Spot" claims the spotlight in next week's programmes. This thrilling gangster play by that master of desperate situations and complicated plots—Edgar Wallace—will be heard in a broadcast version by Howard Rose, Regionally on Monday at 8.15 and Nationally on Tuesday at 8.15.

The part of Tony Pirelli, the gang leader, will be played by Arthur Gomez, who understudied Charles Laughton in the London production and played the part on tour. Because of his brilliant acting he received a glowing letter of congratulation from Edgar Wallace himself.

The cast will also include Florence McHugh as Min Lee, the tragic half-Chinese girl who, at the cost of her own life, brings Pirelli to the electric chair; Wilfred Essex as Kelly, chief detective commissioner and the sworn foe of all gangsters; George Pughe as O'Hara, Joan Miller as Maria Ponleski, and Cyril Gardiner as Jimmy McGrath.

"KING ARTHUR" IN EVENING DRESS

THE listener sometimes has an advantage over the concert-goer. It is difficult, in the

refined and superheated atmosphere of the Queen's Hall, to envisage scenes necessary for a full appreciation of a musical drama such as "King Arthur," words by the poet Dryden, music by Purcell, first produced in 1691.

Next week the disembodied voices of such famous artistes as Noel Eadie, Kate Winter, Enid Cruickshank, and Parry Jones will conjure up for National listeners the days of real chivalry; in the Queen's Hall, however, the audience will need keen imagination, as they gaze at the artistes in their evening dress, to envisage "marshy land near a battlefield," "a place of heathen worship," and "prospect of winter in frozen countries."

For next Wednesday's broadcast (National, 8) the B.B.C. Music Department has collated all the orchestral parts from a number of original MSS. The B.B.C. Chorus and B.B.C. Symphony Orchestra will be conducted by Dr. Adrian Boult.

IN A DILEMMA

A MAN on the horns of a dilemma is always an interesting spectacle. George Scott Moncrieff assumes the rôle in a talk in the "Decision" series on Thursday next (Reg.),

Listeners' C

Outstanding Broadcasts at Home and Abroad

"ON THE SPOT," Edgar Wallace's Chicago gangster play, will be heard in a radio version by Howard Rose on Monday and Tuesday. The play lives up to its title in the exciting episode depicted in the photograph.

He has won the professional championship every time he has entered and is a demon pottier. Horace Lindrum, however, is a worthy challenger who so far has defeated all the leading players except Davis.

The commentator's box will be in one corner of the hall, and the microphone will be placed so as to pick up the click of the balls, the applause, and the marker calling the score.

FAY COMPTON IN "CYMBELINE"

By coincidence, the week that sees a performance of Dryden's "King Arthur" also includes a broadcast of Shakespeare's "Cymbeline," dealing with the fortunes of another king of Britain. Fay Compton appears as Imogen in Peter Cresswell's broadcast version at 5.20 on Sunday (Nat.). The part of Iachimo will be taken by Leon Quartermaine. A large cast also includes Norman Shelley as Cymbeline and Carleton Hobbs as Cloten. This tragi-comedy, lasting two hours, will probably include two-thirds of the play as Shakespeare wrote it.

when, as an alleged rich industrialist who has made his money in the South of England, he will reason whether he should spend his last days in rural Sussex or retire to the Highlands to

devote his money to the resettlement of his native glen.

What would you do?

SNOOKER BROADCAST

BROADCAST history will be made at 8 on Tuesday next (Reg.). The first running commentary of a snooker match—from Thurston's famous hall in Leicester Square—will be given by Willie Smith, watch-

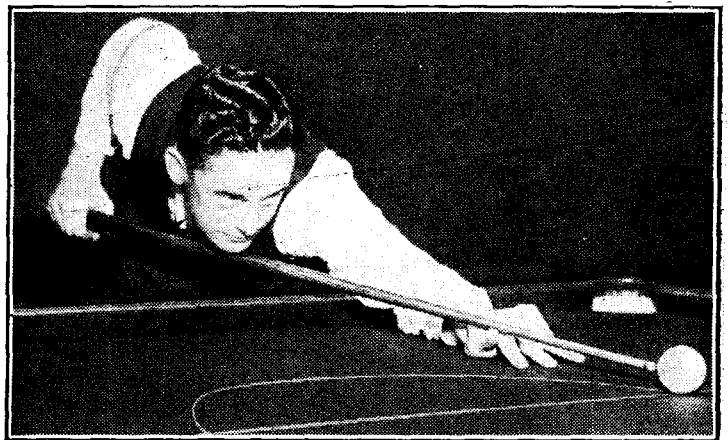

FIRST SNOOKER BROADCAST. Horace Lindrum, nephew of the world's billiards champion, takes part in an exhibition snooker match with Davis at Thurston's Hall on Tuesday. A running commentary will be given by Willie Smith.

ing Joe Davis in an exhibition game with Horace Lindrum, nephew of Walter Lindrum, the world's billiards champion.

Davis is considered to be the king of snooker players.

RUGGER AND SOCCER:

INTER-VARSITY MATCHES

THE Inter-Varsity Rugger and Soccer matches will both be broadcast next week. At 2.5 on Tuesday (Reg.) Capt.

Guide for the Week



EFFIE ATHERTON in full cry during an Air-do-Wells programme. This popular concert party comes to the "mike" on Wednesday (Reg. 7.45) and Thursday (Nat. 8.30).

H. B. T. Wakelam gives a running commentary on the Oxford v. Cambridge Annual Rugby Union match at Twickenham. Of the fifty-nine matches already played, Oxford has won twenty-seven and Cambridge twenty-two; ten have been drawn.

George F. Allison will describe the second half of the annual Association match between the two Universities to be played at Highbury on Wednesday (Reg., 3.15). Oxford has won twenty-five of the fifty-seven already played and Cambridge twenty-four, eight having been drawn.

OPERA ABROAD

NOT all operas are renowned for their orchestration, but this is the main characteristic of Planquette's "Rip Van Winkle," which Budapest is relaying from the Royal Opera at 6.30 this evening.

Rome is giving Verdi's lesser-known opera, "Don Carlos," at 8 to-morrow, while Brussels No. 2 offers a programme at 6 which, although not an opera in itself, will greatly interest opera lovers. The occasion is a lecture-recital on the Evolution of Opera, dealing especially with grand opera and opera-comique; Bizet's "Carmen" has been chosen for analysis. "Carmen" itself is Monday's programme on Warsaw at 8.30.

HIGHLIGHTS OF THE WEEK

FRIDAY, DECEMBER 6th.
Nat., 8, B.B.C. Orchestra, with Miriam Licette (soprano). Conductor: Desiré Defauw. 10, Samuel Butler, by Desmond McCarthy. 10.20, The Little Show.

Reg., 8.15, "The Waltz Dream." 9.20, Pianoforte Recital by York Bowen.

Abroad.
Warsaw, 7.10, Jacques Thibaud (violin) and Station Symphony Orchestra.

SATURDAY, DECEMBER 7th.
Nat., 2.5, Ruggier: Ireland v. "All Flacks." 8.30, Music Hall. B.B.C. Theatre Orchestra.

Reg., Band of H.M. Grenadier Guards. Boyd Neel String Orchestra. Troise and his Mandoliers. 11, Henry Hall's Hour.

Abroad.
Radio-Paris, 8.45, Operas: "La Légende du Pont d'Argentan" (Fourdrain) and "Susanna's Secret" (Wolf-Ferrari).

SUNDAY, DECEMBER 8th.
Nat., Eugene Pini and his Tango Orchestra. 5.20, "Cymbeline" (Shakespeare). Two piano recital: Ethel Bartlett and Rae Robertson. 9, Callender's Senior Band.

Reg., Commodore Grand Orchestra. 9.20, Sunday Orchestral Concert. Conductor: Ernest Ansermet.

Abroad.
Vienna, 6.45, Sibelius Birthday Concert.

MONDAY, DECEMBER 9th.
Nat., 8.30, Harry Welchman and B.B.C. Theatre Orchestra.

Reg., B.B.C. Dance Orchestra. 8.15, "On the Spot" (Edgar Wallace). Medvedeff's Balaika Orchestra.

Abroad.
Frankfurt, 9.15, St. Nicolas pays a visit to the Taunus mountains.

TUESDAY, DECEMBER 10th.
Nat., 8.15, "On the Spot." B.B.C. Theatre Orchestra.

Reg., 7, Relay of "Twenty-to-One" (Coliseum). Commentary on Snooker Match. B.B.C. Orchestra.

Abroad.
Brussels I, 8, International Congress of Sacred Music.

WEDNESDAY, DECEMBER 11th.
Nat., 8, "King Arthur" (Dryden): B.B.C. Orchestra, conducted by Adrian Boult. Leslie Bridge-water's Quintet.

Reg., 7.45, The Air-do-Wells. B.B.C. Military Band.

Abroad.
Deutschlandsender, 6, "Good Evening, dear Listener"—humorous musical programme.

THURSDAY, DECEMBER 12th.
Nat., 8.30, The - Air - do - Wells. B.B.C. Orchestra.

Reg., 7.45, "The Table Under the Tree," with Walford Hyden's Band. Organ Recital by Sir Walter G. Alcock.

Abroad.
Munich, 7.10, Opera: "The Musician" (Bittner).

OPERETTA

LECOQ, the ever-tuneful, opens the operetta programmes this week with his "Petite Mariée" and "Les Pres Saint-Gervaise" forming the 8.45 programme from Radio-Paris. The same composer is represented in the Warsaw programme at 7 to-morrow with a concert version of his "Le Jour et la Nuit."

The strange fascination which gypsies have for musicians is reflected in Knopf's three-act operetta, "De Blonde Zigeuner," which fills the bill at the Flemish Theatre Royal, Ghent, at 8 on Sunday and is to be relayed by Brussels No. 2.

SIBELIUS

SUNDAY next is the seventieth birthday of the great Finnish composer Sibelius, and not a few broadcasting stations are commemorat-

sander with augmented Station Orchestra. Königsberg (Heilsberg) gives its Sibelius concert to-morrow evening at 7.50, the Station Symphony Orchestra being conducted by Brückner.

CONCERTS

NOTABLE concerts this week include Respighi conducting his own music at Milan at 8 this evening, the programme including an arrangement of this modern master of Monteverdi's opera, "Orfeo"; in the Vienna programme at 8 this evening is Mozart's seldom-heard E flat Concerto for two pianofortes and orchestra, the brothers Hans and Heinz Scholz being the soloists. There are two other Mozart concerts on Thursday, December 12th: from Strasbourg at 8.10, and from all German stations at 7.10.

A RAILWAY BROADCAST

BRESLAU offers an exciting item at 6 on Thursday, when listeners will be taken on a train journey from Breslau to



SIBELIUS AT HOME. The 70th birthday of the great Finnish composer occurs on Sunday, and the event is being celebrated by a large number of Continental stations.

ing the event in worthy fashion. Vienna has a Sibelius birthday concert by the Symphony Orchestra at 6.45 on Sunday, which is competing with Munich's celebration at 6, consisting of the Sibelius Violin Concerto played by Karin Ros-

Berlin. The programme, which was recorded during an actual night journey, will describe the intricate arrangements of the railway company to provide for the safety and comfort of travellers.

THE AUDITOR.

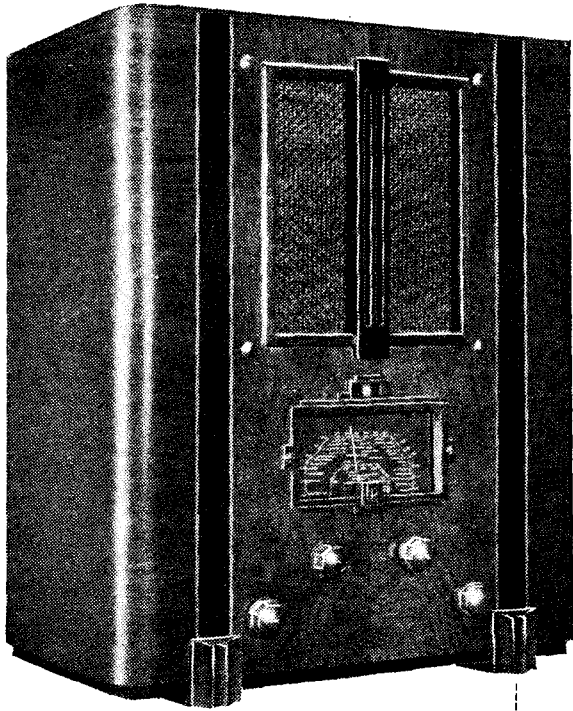

Ever Ready

MODEL 5003

A Sensitive and Selective Superheterodyne with Efficient Interstation Noise Suppression

As far as appearance, finish and value for money are concerned this receiver may be taken as representative of the range of sets with which Ever Ready sprang fully armed into the field of set manufacture this season. It is a four-valve superheterodyne designed for operation from AC mains only, and while it is not inferior to other receivers in the same class in any of the essential qualities of range, selectivity and tone, there are many features which distinguish the performance and invest the set with individuality.

Of these the QAVC control must be given first place. The clean cut-off is in every way equal to the performance one usually expects from sets employing a separate valve for this purpose in conjunction with a mechanical relay. Yet

FEATURES. — *Type.* — Table-model superheterodyne for AC mains. *Circuit.*—Octode frequency-changer—var-mu pentode IF amplifier—double-diode-triode second detector—triode output valve. *Full-wave valve rectifier.* **Controls.**— (1) Tuning. (2) Volume and on-off switch. (3) Tone. (4) Waverange. **Price.**—14 guineas. **Makers.**—Ever Ready Radio Ltd.

these results have been obtained with no more complication than the addition of a few judiciously placed resistances in the second detector stage.

In second place we would put the freedom from background noise and complete absence of second channel and self-generated whistles on both wavebands.

We refer, of course, to the behaviour of the set at full sensitivity and with the QAVC control out of action.

Thirdly, the quality of reproduction is to be specially commended on account of the unusual quality of the bass response and the general clarity of reproduction. The Magnavox loud speaker is of a new design incorporating one of the exponentially curved diaphragms. Its fundamental resonance is extremely low, yet the motion is sufficiently well damped for this to be kept well under control. As a result the bass response seems to be exactly right at all positions of the volume control, and we are at a loss to understand why the makers have included a pull-out switch in conjunction with the tone control in order that the bass can be eliminated. Perhaps this feature of the chassis has been retained from a time when some other type of loud speaker unit was contemplated.

Tuning Indicator

While on the subject of controls the tuning indicator is deserving of special mention. It is of the type in which the filament current of a pilot lamp is reduced as the result of an increase in the strength of the incoming signal. With the special type of lamp employed the action is quite free from time lag and the position of exact tune can be judged with surprising ease and certainty.

The first valve in the circuit is an octode frequency-changer which is preceded by a band-pass filter with direct magnetic

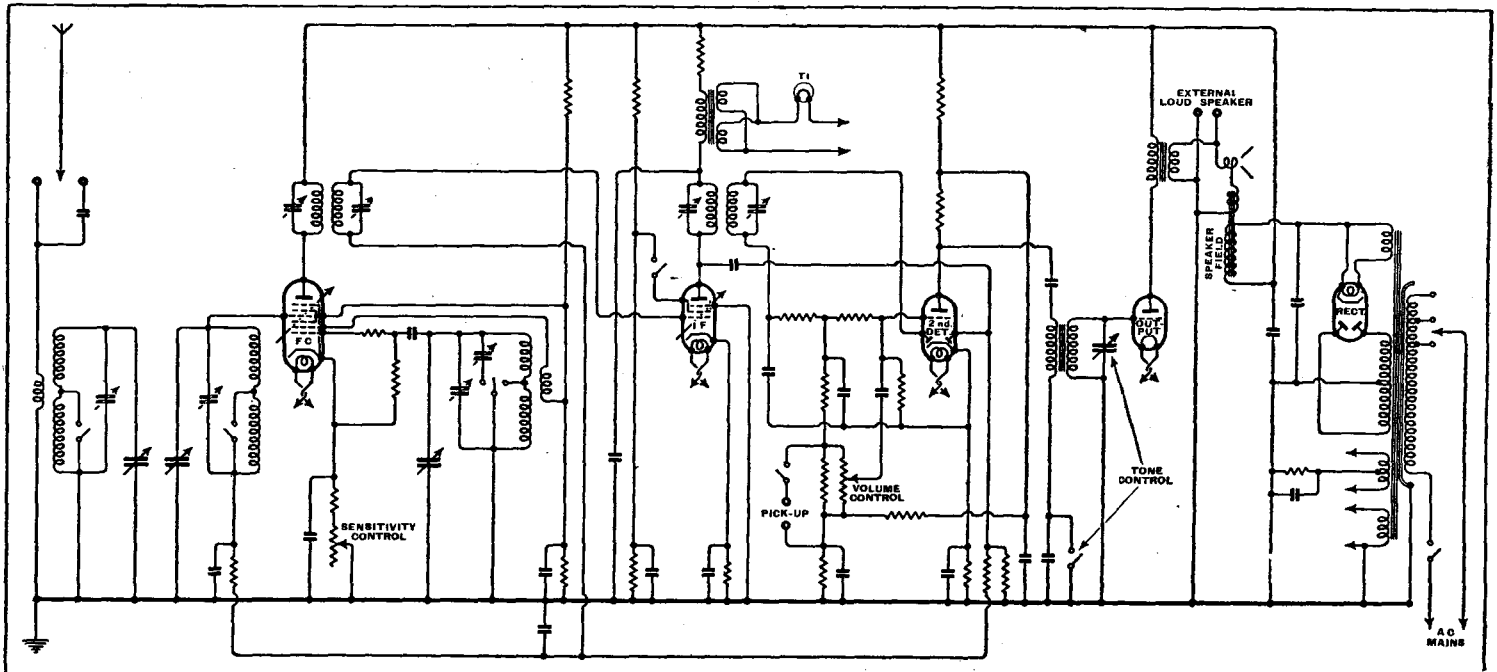

Complete circuit diagram. The current in the tuning indicator lamp is controlled indirectly by the IF amplifier anode current, which alters the inductance of the chokes in series with the lamp.

Ever Ready Model 5003—

coupling between the two elements. An alternative aerial tapping which introduces a small series condenser is available for use when the receiver is operated close to a powerful transmitter. Normally, however, the universal aerial coupling may be used without fear of overloading, and with this arrangement an equally high efficiency is obtained on both wavebands without any evidence of break-through of medium wave stations on the long waveband.

signals only slightly below the critical value and the background is completely silent.

The second detector is coupled to the triode output valve through a specially designed low-frequency transformer, in which the effect of a variable condenser across the secondary produces a sharp variable cut-off which is the best form of tone control. The reduction of extreme bass previously mentioned is effected by introducing a small condenser between

Taken as a whole, the Model 5003 gives the impression that it is a finished production in which no loose ends have been left which require clearing up. It gives clean reception with the minimum of distraction from incidental noises.

DISTANT RECEPTION NOTES

IF there is any truth in a rumour that Russia contemplates the erection in the near future of a broadcasting station with a power rating of 2,500 kilowatts it must be giving the International Broadcasting Union furiously to think. So far as I know, there are only two broadcasting stations in the world now which are rated at as much as 500 kilowatts. These are WLW of Cincinnati, Ohio, U.S.A., and Moscow No. 1. Next below them in order of power come Luxembourg, Droitwich and Brasov with a mere 150 kilowatts.

Gigantic as the country is, Russia must be pretty well served already by the multiplicity of stations which she possesses. Many of these are in the high-power class with outputs ranging from 20 to 100 kilowatts; there are numbers of 10-kilowatt stations, and so far as I know only one (the 2-kilowatt Ukhta on 309.9 metres) of lower power than this. Further, the Russians have managed to acquire an extraordinarily good selection of wavelengths. They have nine stations in operation on the long waves between 1,071.4 and 1,724 metres; five on the intermediate band between 688 and 845 metres; eight in the upper part of the medium-wave band between 307.1 and 463 metres, and only five below 300 metres, the lowest wavelength used being 253.2 metres.

The probable explanation of the rumour is a proposal for linking several stations for the same programme, the total power radiated being the combined power of several stations and reaching the figure of 2,500 kilowatts.

It seems to me that whatever the projected Russian plan is it must be intended mainly for propaganda broadcasts to other countries.

At the same time, it has been said with some truth that if you want to ensure interference-free reception for your own people the only way is to erect stations so powerful that they can shout down others by sheer force of kilowatts. Other countries in Europe are building stations of higher and higher power, whilst many of the newest plants are so designed that the output can be increased greatly when required. You may have heard the new Government station at Toulouse testing on 386.6 metres after eleven o'clock at night. At present this station is using 60 kilowatts. Its kilowatt quota under the Lucerne Plan is 120, and it will shortly work up to this figure when it takes over the full programme service. The plant, however, is so arranged that the output can be extended, if required, to 200 kilowatts with a minimum of alterations.

Radio-Cité, which has lately been taken over by one of the biggest French newspapers, is shortly to transfer its plant to Argenteuil. The station is now working on 280.9 metres.

The latest French Ferrié station, Marseilles P.T.T., is now testing after 11.0 p.m. on 400.5 metres with a power of 100 kilowatts. Though it is next door to the 100-kilowatt Munich, it is providing good reception on a receiving set of high selectivity.

D. EXER.

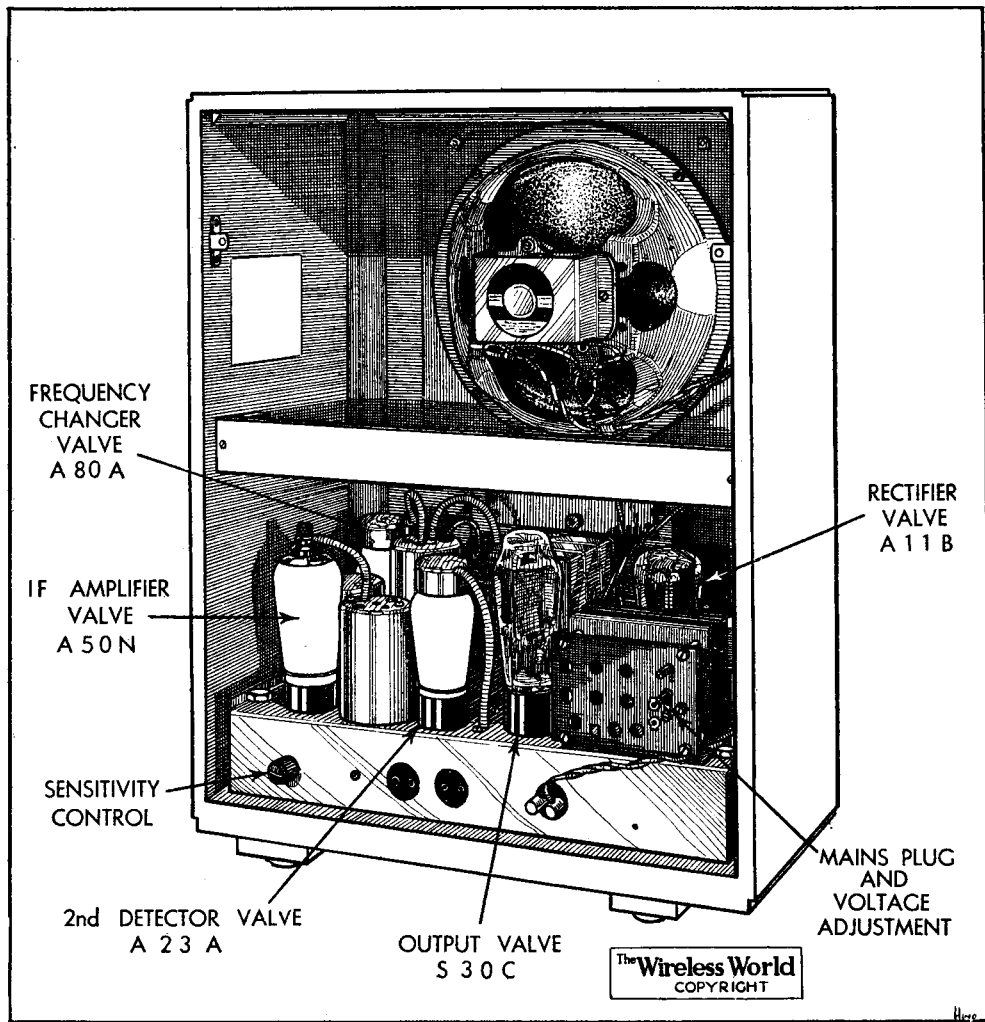

The loud speaker is equipped with the latest type of curved cone. Note the stiffening bar to prevent cabinet resonance.

Both the octode frequency-changer and the variable-mu pentode used in the IF stage are controlled by AVC, for which a diode in the second detector stage has been set apart. The other diode is used for signal rectification and with it is associated the resistance network designed to give inter-station noise suppression with a sharp cut-off and without distortion on heavily modulated passages. Space does not permit a detailed account of the variation of potentials at different points in this circuit throughout the full range of input signals, but the general principle is that the initial bias on the diode and also the bias on the grid of the amplifying portion of the valve are both controlled by the signal. The effect is cumulative, and in consequence the negative bias on the diode is reduced to zero with quite a small input signal. On the other hand, the valve remains completely shut to

the primary and earth so that it is effectively in series with the normal feed condenser.

The set can easily hold its own with other four-valve superheterodynes as far as range is concerned, and the performance in this respect is equally good on both wavebands. An apparent increase above the usual number of stations of good programme value is to be noted, and while this impression is to some extent due to the effective inter-station noise suppression, it could not be achieved without a high intrinsic overall sensitivity.

The selectivity is quite adequate, and if the Deutschlandsender can only be received when at least one of its neighbours is not modulating, the medium-wave selectivity enables the two Brookmans Park transmitters to be approached within one and a half channels before any interference is experienced.

Mica as a Diaphragm Material

HINTS ON CUTTING AND MANIPULATION

By NORMAN ROLLASON

THE following notes are given at the request of many readers who have asked for further constructional details of the wide-range single-cone loud speaker, described in the November 15th issue.

The mica is obtainable from ironmongers in the form of relatively thick sheets, the size required for the speaker being six inches square. It is then necessary to split from this a piece of even thickness in the region of 0.001 inch.

The best implement for the purpose is a sharp-pointed darning needle. This is carefully pushed into the edge of the thick sheet until a thin piece commences to flake off. Experiment and experience are required before this can be done without the mica flaking off into three or more pieces instead of one, but having once started a split the steady advancement of the needle broadside round the sheet will separate the thin sheet without difficulty.

A watch must be kept for little flakes of mica in the wake of the needle, and also lines showing where the mica has torn. If either of these appear, the splitting must be recommenced, otherwise the finished sheet may be uneven. Those with no measuring instruments (micrometer gauges) can, in splitting the mica, concentrate upon obtaining the thinnest sheet which will bear handling and cementing. If the mica is too thin it will break too readily when bent. Should the sheet be thicker than 0.001 inch, up to, say, 0.003 or 0.004 inch, the high note output will not be very much affected, though a peakiness may tend to appear, and the general level will be reduced.

The Cutting Tool

The ubiquitous razor blade is the best tool to use in the cutting of the mica, the mica being laid on a suitable piece of hard wood and the blade pressed through it. If the blade is dragged along, as when cutting paper, the mica will tear.

The speech coil former is wound from thin mica strip on a tubular former which is built up, if necessary, by means of paper to the desired internal diameter of the mica former. The mica strip is then wrapped tightly round the former, which has been smeared with grease of some kind, and cemented together as the wrapping proceeds. Mica is admittedly awkward stuff to handle, but if the thick parts are built up in this way from thinner sheets, the trouble which it gives is minimised.

The paper disc having been cut for the cone, two circles are marked thereon, one a shade less than six inches in diameter for locating the position of the mica, and

the other five and a half inches in diameter. This smaller circle is cut out after the curved seam lines have been marked out as indicated in the sketch. The radius of the seam lines is not criti-

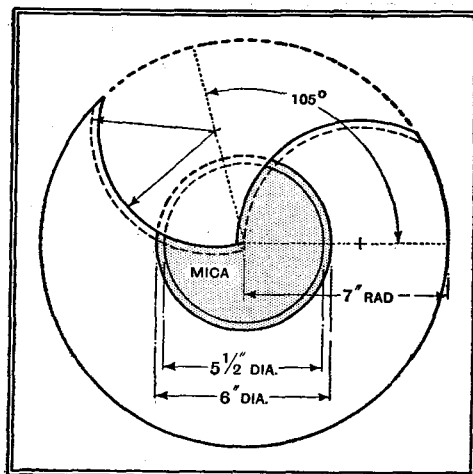

Plan view showing development of the cone ready for cementing the main seam.

cal provided that it is a little more than $3\frac{1}{2}$ inches. So long as the centres lie on the 105-degree lines, a true 90-degree cone will be formed.

The mica disc is next cemented on to the paper and left for five to six hours to set under pressure. When the joint is thoroughly set the lines for the seam can

be cut along with the razor blade, and the seam cemented.

Whilst the seam is setting under pressure, the celluloid "spider" may be cut out. The best way of "cutting" this is to scratch it deeply as required, and then bend sharply in both directions along the lines. The spider may then be cemented to the mica speech-coil former with cement made from acetone and celluloid. This is used here instead of the rather more adhesive amy! acetate—celluloid mixture because it is a more rapid drier. Since the spider must be held whilst the cement sets to a certain extent, the reason for the change is obvious. In other parts the amy! acetate—celluloid mixture is used. Care should be taken to avoid smearing the acetone mixture over more of the spider than is necessary. If the spider is too well cemented it will be distorted on drying out.

The cone should next be placed base downwards on a perfectly even, level surface, and the apex coated with cement in the place which the mica former will occupy. The former is then pressed firmly into position, and the cement brushed evenly round it, inside and out. The former must be absolutely parallel with the axis of the cone, and in this position it should be left under pressure for six to eight hours. When the joint is hard the apex of the cone as far as the edge of the coil former should be cut away, leaving just enough overhang to give strength to the joint. It only remains to solder very flexible connecting wires to the speech coil, and attach the front spider.

NEWS FROM THE CLUBS

The Trousers Test

Two pairs of flannel trousers were sacrificed by Mr. J. A. Delves-Broughton, of the Croydon Radio Society, before he discovered the best kind of cloth for holding the outer edge of the cone to his new loud speaker. In a recent lecture before the Society Mr. Delves-Broughton described his experiments in designing a cone in which no "spider" or centring device was necessary. The cone was held by its outer edge, and it was important that the surround material should be concentrically woven, giving the same tension all round, hence the trousers tests. Hon. Publicity Secretary, Mr. E. L. Cumbers, 14, Campden Road, South Croydon.

A Visit to Droitwich

Members of Slade Radio (Birmingham) visited the B.B.C. station at Droitwich on a recent Saturday and were escorted over the entire plant in small parties by a number of guides.

The Society's winter programme is now in full swing. Applications and enquiries regarding membership should be addressed to the Hon. Secretary, Mr. C. Game, 40, West Drive, Heathfield Park, Handsworth, Birmingham.

Micro Waves

Transmission on micro waves, using an early "R" type valve with a thorated Tungstram filament were carried out by Dr. Lemon and

Mr. Hobbs (G2QG) at a recent meeting of the Radio Physical and Television Society.

The Society, which is anxious to increase its membership, is planning the installation of a club transmitter. Hon. Secretary, Mr. E. Arnold, 12, Nassau Road, Barnes, S.W.13.

New Peterborough Society

A radio club is being formed in Peterborough. Full particulars can be obtained from Mr. C. Smith (G2UQ), "Kenec House," New Road, Whittlesey.

Ealing Society

A Wireless Society is being formed in the Ealing district. Full particulars can be obtained from Mr. H. Williamson, 22, Camborne Avenue, West Ealing, W.13.

Dartford Society

Messrs. Voigt, Ltd., gave an interesting demonstration of their speakers before members of the Dartford and District Wireless and Television Society on November 18th. Hon. Secretary, Mr. D. G. Preston, 67, The Brent, Dartford.

Exchange of Ideas

An American group of amateurs interested in the interchange of ideas and radio designs would like to correspond with a similar group in England. British amateurs are requested to address enquiries to Mr. C. Zwanzig, 3rd, 1404, W. Madison Street, Ottawa, Illinois, U.S.A.

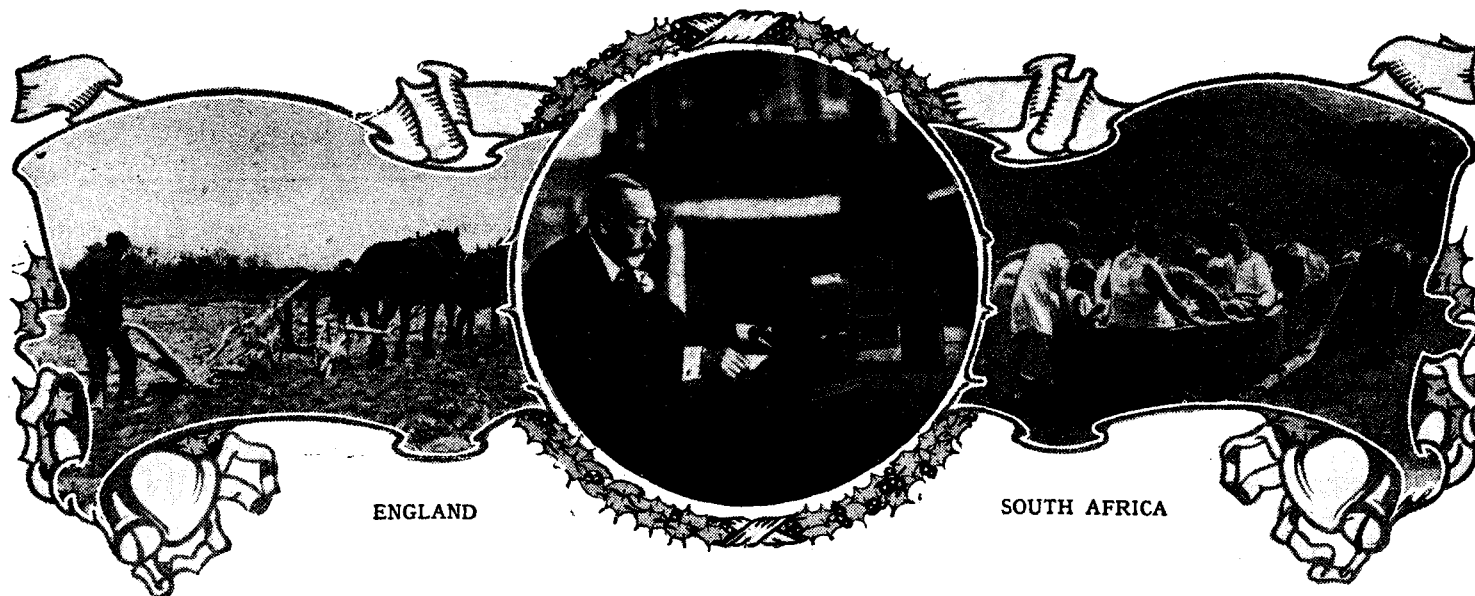

ENGLAND

SOUTH AFRICA

"This Great Family"

ROUND THE EMPIRE
ON CHRISTMAS DAY

UNTHOUGHT of ten years ago, the "Round the Empire" broadcast on Christmas afternoon has now become an institution, culminating as it does each year in the gracious family message of His Majesty the King.

Under present arrangements the King will again address his subjects this Christmas, speaking from his study at Sandringham to a "great and widespread family"—to quote His Majesty's own words on a previous occasion—literally spread throughout the length and breadth of the earth.

Preceding the Royal greeting at 3 p.m. will be a feature programme, the Empire joining in, in which sound pictures will come from Canada, South Africa, India, Australia, and New Zealand, interspersed with corresponding "vignettes" from the English towns and countryside.

The programme will open in London at 2.30 with the singing of the carol "God Bless the ruler of this House." Then will follow the Canadian contribution, consisting of a brief relay from a family party in Ottawa. South Africa will participate with the festive sounds of a Christmas party in Cape Town, while, if present

arrangements hold good, India will contribute a realistic sound picture from a shooting camp.

Both Australia and New Zealand will take the microphone to typical family parties—the former in Sydney and the latter in Wellington.

Greetings in Gaelic?

The British contributions will come from the North, the South, Scotland, Wales and Ireland. Possibly the Scottish party will be a Gaelic one in Aberdeenshire. Another novelty will be a message from a New Zealand grandfather to his grandchildren in England who will be taking part in the programme.

Production of this elaborate feature is in the hands of Felix Felton, who is already busy on an intricate time-table devised to include the entire broadcast, "live" and recorded, in the space of thirty minutes.

Musical interludes will link up the relays, and will be contributed by the Wireless Chorus, the B.B.C. Military Band, and the organ in the Concert Hall, Broadcasting House.

Many technical difficulties have to be overcome, not the least of these being the time problem. For example, the Sydney contribution originates on Boxing Day in the Antipodes, and the family there will be describing the pleasurable experiences of yesterday.

As in previous years, the hub of this vast broadcast network will be at Faraday House, Queen Victoria Street, London, where the Post Office main telephone exchange is situated. The beam messages received here will be passed on to the Control Room at Broadcasting House.

The Empire always evinces the greatest enthusiasm in these world broadcasts. The B.B.C. is working in close co-operation with the Australia Broadcasting Commission; the New Zealand Broadcasting Board; the African Broadcasting Company, Limited; the Controller of Broadcasting, Government of India; and the Canadian Radio Broadcasting Commission.

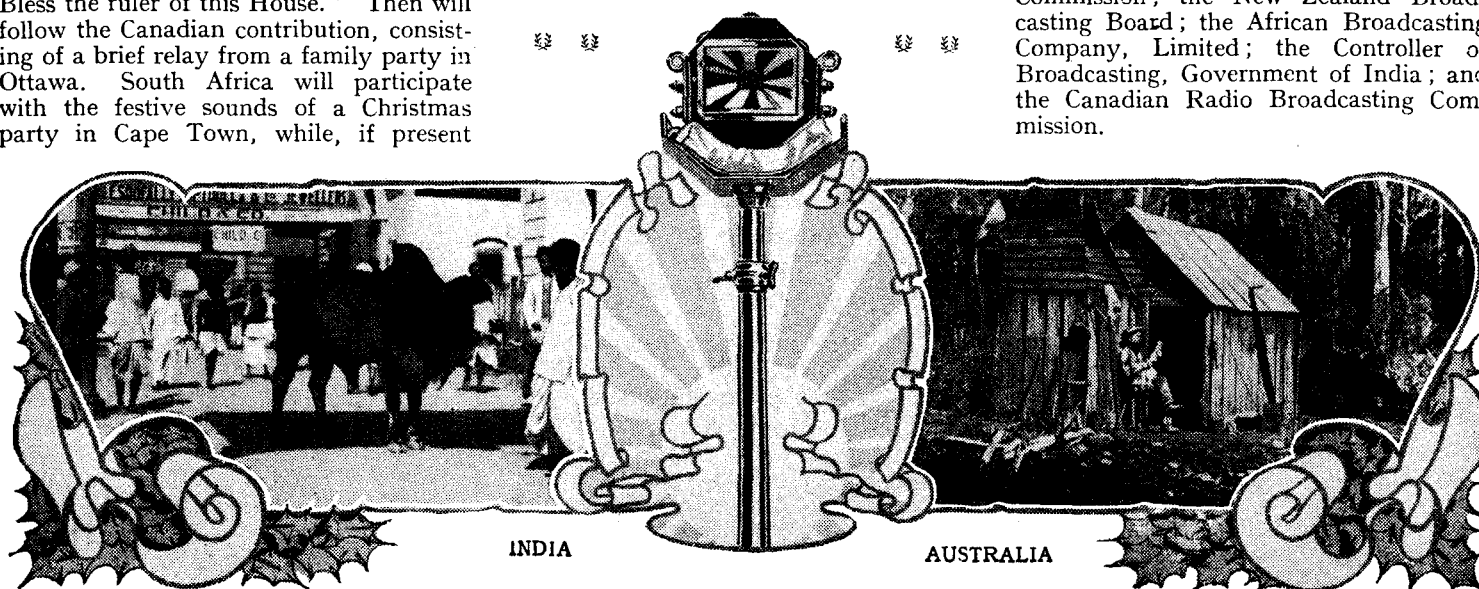

INDIA

AUSTRALIA

HINTS and TIPS

Practical Aids

HESITATION to interfere with the trimming adjustments of a receiver is sometimes due to the fear that the wavelength (or station-name) calibration will be interfered with. It is worth while pointing out that in dealing with super-

Ganging and Calibration

In practically every case the oscillator circuit is by far the most sharply tuned of all those in the receiver, and so it will take charge of the tuning as a whole.

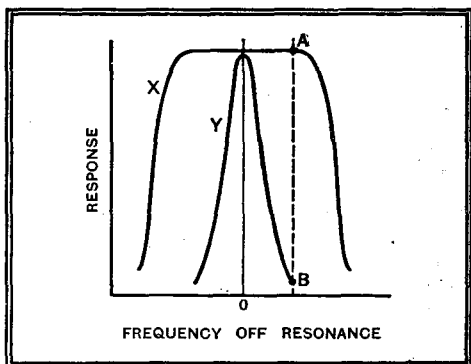

Fig. 1.—Illustrating the rule that a variable-selectivity receiver should always be tuned with the control adjusted for maximum selectivity.

OPERATION of the perfect selectivity control should introduce no variation in tuning; in fact, the resonance curve should contract or expand symmetrically about a fixed point corresponding precisely to resonance with the desired signal.

Variable Selectivity: An Operating Hint

It is pleasing to record that something closely approaching this desirable state of affairs has already been reached, but it is the purpose of this note to point out that immunity from apparent "tuning shift" can only be attained if the operator himself does his part; the normal action is not purely automatic and fool-proof.

The safe rule to remember in all circumstances is that the desired station should always be tuned in with the control adjusted for maximum selectivity.

The reason for this will be apparent from a consideration of Fig. 1, which shows the resonance curves, perhaps slightly idealised, of a receiver with its control at minimum (X) and maximum (Y) selectivity. Now imagine a station to be tuned in with the control incorrectly set at minimum selectivity: judging either by ear or with a tuning indicator it will be impossible to determine the precise point of resonance, as signal strength will be equal over an appreciable range of rotation of the tuning knob. Unless one is lucky, or

to Better Reception

has a good enough ear to appreciate distortion due to mistuning, the point finally arrived at may well correspond to A.

If the control be now turned to maximum selectivity the wanted signals will entirely disappear, as the tuning in this position will correspond to point B on curve Y, and the signals will only reappear after retuning. But the responsibility for this apparent detuning is clearly to be ascribed to the operator, and not to the set.

IN a recent article it was pointed out that anyone choosing a receiver as a result of personal tests should constantly be on his guard against allowing local conditions to influence his mind unduly. Even experts who are constantly handling sets of

Making Comparisons

different kinds are often at a loss to know precisely what allowance should be made for exceptionally good or exceptionally bad local conditions.

When comparisons are to be made between two sets of approximately the same performance, it is extremely helpful if matters can be so arranged that a quick-change-over from one to the other can be effected. Both receivers can be joined simultaneously to the same mains and earth connections, and it is an excellent plan to arrange a temporary change-over switch for transferring the aerial rapidly from one to the other so that the behaviour of the two when receiving the same station may be directly compared without waiting for the valves to warm up each time.

It is well to remember, however, when dealing with superheterodynes, that complications are apt to arise due to the fact that radiation takes place from the oscillator circuits of each set. It is sometimes worth while going to the trouble of providing means for short-circuiting one of the oscillator coils of each set in order that one may be temporarily "silenced" while the other is under test.

WHEN revalving an old set of the AC mains type, even though the original rectifier may still be capable of giving an adequate high-tension output, it is often worth while substituting a new valve of the indirectly heated type. Firstly, apart

Rectifiers and Reliability

from the "newness" of the valve alone, the efficiency of the IHC type is slightly higher than that of the older patterns, and so quite a useful increase in HT voltage is likely to result. Secondly, the smoothing condensers in the receiver

will be entirely relieved of an enormous amount of high-voltage strain while the receiving valves are warming up from cold and consequently taking no anode current. Experience shows that condenser insulation is inclined to deteriorate with damp, dirt, heat and, above all, with the passage of time, and it is an unfortunate fact that condenser breakdowns are comparatively common where an attempt has been made to economise by using doubtful makes or condensers of inadequate voltage rating. By fitting an indirectly-heated rectifier, which warms up at the same rate as the other valves, overworked condensers are given an extra margin of safety, for they are not then required to withstand any voltage higher than their normal working value. The reliability of the receiver as a whole is therefore obviously improved, and in many cases probably to an extent that entirely justifies the outlay on the extra valve.

IF one is unfortunate enough to break off the top cap of a valve, it does not automatically follow that irreparable harm has been done. But, as often as not, it will be found that the leading-out wire, through which connection to the underside

Valve Cap Repair

of the terminal was originally made, has broken off flush with the surface of the glass. This means that exceptional care must be taken in joining on a length of wire for external connection, either to the original terminal or in some other manner.

As a rule, though it will just be possible to solder on a length of fine wire, the joint will have little mechanical strength.

A small quantity of "plastic wood" moulded round a re-soldered anode connection provides a secure anchorage for the joint.

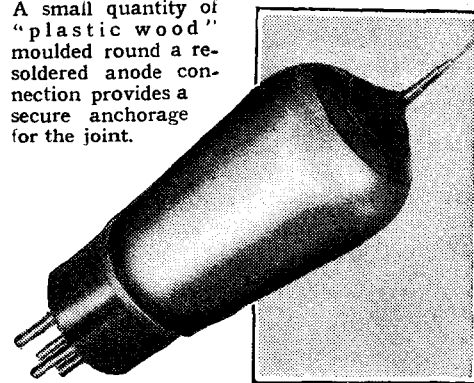

In such circumstances the necessary strength may be provided by means of some suitable plastic material; ordinary "plastic wood" serves the purpose extremely well, and a small quantity can easily be moulded around the wire in the manner shown in the accompanying photograph. Here the extemporised "lead out" is a short length of wire.

Broadcast Brevities

Burghead Testing

NO prizes can be offered, so it must be for "amusement only"—as the automatic fortune-telling machines put it—that we must try to discover the "secret" wavelength on which North Scottish is now testing.

I understand that the mobile transmitter has been very successfully hitched up to the new 500ft. aerial and that the engineers have been operating it for an hour or two at a time.

Defying the Lucerne Plan?

According to the *complete* Lucerne Plan, published only in *The Wireless World* (June 23rd, 1933), Burghead must work on 267.4 metres, and Sir Noel Ashbridge and his assistants will have to adduce fairly cogent reasons if they wish to depart from the considered decisions of the International Broadcasting Union.

Actually, a campaign is seething below the surface to secure a much higher wavelength, which would help Burghead to project its signals over the mountains which lie between the little Morayshire town and a large area of the Highlands which the station is intended to serve.

Radio "Sanctions"

The fact that the Broadcasting Union is powerless to enforce its rules deters some countries from breaking faith, while it encourages others. I imagine that Britain belongs to the former category of nations, and that the B.B.C. would only run counter to the Lucerne Plan after consultation and agreement with the Union.

Has anyone ever considered the possibility that the International Broadcasting Union might organise "sanctions" against countries guilty of flagrant wavelength wobbling?

Bringing Offenders to Book

While it is difficult to say what form these sanctions might take, there are one or two directions in which the Union might bring quite a chastening force to bear upon an offender. For example, all broadcast programmes from the country in question could be boycotted, i.e., relays over the European network would be stopped and, so far as possible, all mention of the country's broadcasting activities omitted from the radio Press.

Healthy Heterodynes

If such a boycott had no effect resort might be had to disciplined jamming, each member-country of the Union undertaking to saddle the offender with a healthy heterodyne on a particular night, according to a specially prepared time-table.

The country that could withstand treatment of this sort for more than a month would deserve to have the ether to itself.

Studios Galore

Charles Brewer, who produces the "Scrapbooks," tells me that the last—"1911"—was the most complicated of all in production. These programmes do not *sound* self-consciously complicated, in the way that some "experimental" radio plays do, but they are necessarily so owing to the fact that they draw upon almost every branch of the B.B.C.'s resources; there is speech, music, records old and new, and effects.

EMPEROR OF
ABYSSINIA in
happy mood
when he broad-
cast a few days
ago to listeners
on the American
Columbia
Broadcasting
network.

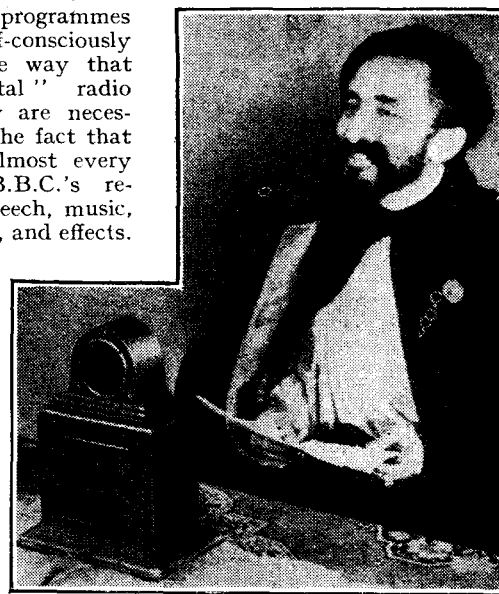

141 "Flicks"

For "1911" two speech studios, a large orchestral studio, two effects studios, and echo rooms were used. These were connected to the dramatic control panel, which was operated by Mr. Brewer and Mr. Rex Howarth.

During the hour's transmission they had to carry out 129 "fades," and they gave 141 cue lights, or "flicks," in B.B.C. parlance, to the studios.

And the Next

Will this record be beaten in the next "Scrapbook"? The year will be 1901—the earliest so far dealt with.

Christmas Broadcasting

A MAN with a wireless set could spend his Christmas alone and still have a good time. This is the inevitable reflection after a dazzled glimpse through the B.B.C. programme lists for the week ending December 28th.

From Sunday to Saturday the ether will be crowded with reminders of the festive season.

All the Best

I suppose the Festival really begins, wirelessly speaking, on Monday, December 23rd, when Stanford Robinson and the B.B.C. Theatre Orchestra share a programme with Henry Hall and the B.B.C. Dance Band featuring "Tunes of the Year"—all the best melodies of 1935, from "hot" to the other extreme.

Miracle Play

There are two interesting "O.B.'s" on the same day.

The first is the Rev. Bernard Walke's new miracle play, "The Stranger of St. Hilary," relayed from the Cornish village of Marazion. The second relay is of the forty-second annual banquet given to little Londoners by the Lord Mayor in the Guildhall.

Carols

Listeners who can appreciate the magnificent acoustics of King's College Chapel, Cambridge, will revel in the carol singing relayed from the Chapel on Christmas Eve afternoon; later there will be the customary carol broadcast from St. Mary's Church, Whitechapel.

Bransby Williams

Another first-class broadcast of its kind should be Bransby Williams' character studies in a feature programme, "A Christmas Eve Fancy," also on December 24th.

Nor must I forget to mention a second "All Girls Together"

By OUR SPECIAL CORRESPONDENT

programme which Max Kester is producing on Christmas Eve. The first was not, perhaps, the success that was hoped for, as the ladies appeared to be too self-conscious without male support.

Christmas Day

The chief event of Christmas Day is, of course, the annual broadcast by H.M. The King, which is fully referred to on another page of this issue.

An innovation will be the broadcasting of the Boar's Head ceremony from Queen's College, Oxford—a picturesque survival of an age-old banquet in which a real boar's head—complete with orange in mouth—is consumed.

Biblical Background

A unique religious programme is to be given in the evening of Christmas Day. At 6.10 Robin Whitworth will introduce a feature built up from extracts from the great poets and musicians set in a framework from the Bible, leading from the Old Testament story of the Creation to the Nativity.

Gracie Fields Relay from Johannesburg

Later on Christmas evening comes the annual party, from St. George's Hall. Besides musical games, chatter, songs and Christmas stories, a charade will be staged. Clapham and Dwyer, Stainless Stephen, Tommy Handley and many other favourites will join in the fun. It is hoped that Gracie Fields may contribute to the programme from Johannesburg, where she is spending Christmas.

Boxing Day

"No Ordinary Kentucky Minstrel Show" is being staged by Harry Pepper on Boxing Day. It is to be a really old-fashioned coloured folks' Christmas party; the troupe will just sit around wearing paper hats and, I imagine, behave as they would at home.

Robert Loraine as Scrooge

A splendid round-off to the Christmas broadcasts should be Robert Loraine's production, on Boxing Day and December 27th, of Dickens's "Christmas Carol" in which the popular actor—just back from Broadway, New York, will impersonate Scrooge.

Letters to the Editor

The Editor does not hold himself responsible for the opinions of his correspondents

The Valve

From Sir Ambrose Fleming, Kt., F.R.S.

I HAVE been looking at your Valve Number of November 22nd. It may be of interest to your readers to know that on the date of your following issue, November 29th, I was eighty-six years old. And the first valve invented by me was patented in Great Britain on November 16th, 1904, just thirty-one years ago.

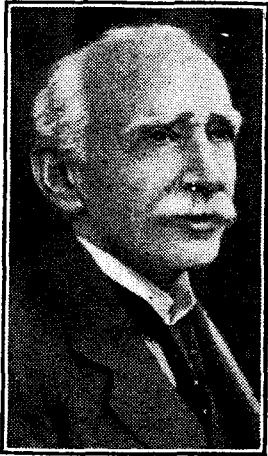

AMBROSE
FLEMING.
S. Devon.

What is All-wave?

MR. F. W. DEWHURST'S letter in your issue of November 1st raises the question of the designation of all-wave receivers. While agreeing with his views on the name "all-wave" being applied to broadcast receivers with a short waveband incorporated, I think the suggested way of describing such receivers is inadequate to the non-technical public.

A three-wave band receiver could have any of the following wave ranges: (a) 12.5-25m., 250-550m., 1,000-2,000m.; (b) 15-60m., 250-600m., 800-2,000m.; (c) 12.5-25m., 24-50m., 250-550m.; (d) 20-60m., 58-100m., 250-580m.

I hope these figures show how misleading such a description would be. It appears that the old way of giving the wave ranges of the various bands covered is still the best method of describing all-wave receivers.

It should be understood that the American all-wave receiver usually covers 15-550 metres without a break, and therefore can be termed all-wave over the maker's stated gamut of frequencies. In this country an all-wave receiver should cover 2.5 to 30,000 metres to deserve such a title.

Lichfield. D. R. PARSONS.

Deaf Aids

I HAVE read Dr. McLachlan's articles on deaf aids with great interest, but as a user and technician I disagree with the assertion that a bone conduction aid is only suitable for the very deaf. A bone conduction aid is beneficial provided that:—

(a) The auditory nerve is sound.

(b) The sensitivity of the aid is greater than that of the patient, i.e., that the aid will amplify sounds which are not heard by the patient. The terms "sounds" used here covers the various softly spoken syllables, consonants, etc., that go to make speech intelligible.

Under (a) will appear deaf persons who normally hear better in trams, buses, etc. Figure 6 in the article dated October 11th for low-tone deafness is typical for outer or

middle ear deafness—not nerve deafness—and therefore is a suitable case for a bone conduction aid.

With regard to (b), the lower the sensitivity of the aid, the more deaf the patient has to be before any advantage is experienced by using the aid. A really sensitive aid is of definite value to anyone, such as myself, whose air conduction has an average value on or near the bone conduction threshold, as given in Fig. 2 of the article under discussion.

There are not many sensitive aids on the market, and before contemplating purchase it is advisable to consult the National Institute for the Deaf, who publish a list of reliable hearing aid manufacturers and dealers.

H. W. FISHLOCK,
B.Sc. (Electrical Engineering).

Records and Recording

CONGRATULATIONS on your efforts for better tone in radio reproduction. Would it be possible, as most sets are now designed for gramophone work, to provide a space in *The Wireless World* weekly for "Notes on Records"?

My point is not so much for current issues but reviews on the merits of different recordings. I find that many vocal records, especially those called vocal gems, are good on solo parts, but in some cases are almost unpleasant in the chorus parts. Are these defects—and they occur in the best of records—due to the original cutting of the master record, or can it be attributed to the reproduction side.

I might add that I have tried several different pick-ups and sets, but the reproduction faults are constant. I should like to hear other readers' experiences and views.

Devon. F. S. THOMAS.

The 1936 Monodial

ALTHOUGH *The Wireless World* is used to hearing praise for their work, I cannot help adding to their number; especially in respect of the 1936 Monodial, as being the most outstanding quality receiver I have yet handled.

Any reader contemplating building this for use in the difficult South Coast district can do so with every confidence. I use the Quality Amplifier; a slight hum experienced was removed by earthing the amplifier instead of the receiver.

Hove, 3. L. B. FRANCIS.

Dance Band Quality

IN the Technical Criticisms of Recent Broadcasts of a recent number of *The Wireless World* your critic commented on the quality of the transmission of the Rhythm Brothers Dance Band, stating that it sounded "very flat and uninteresting." I take it that by "flat" he was not speaking in a strictly musical sense, but that he referred to the lack of life and sparkle in the transmission.

Now, sir, heresy though it may sound to many, I would venture to suggest that the majority of broadcasts of dance bands by the B.B.C. are "flat" in the sense I assume your critic to have used the word, and this applies both to outside and studio broadcasts. One has only to hear the occasional broadcasts of bands from a large dance hall

to realise how dull and lifeless other dance band transmissions sound. The German broadcasting authorities seem far more successful than the B.B.C. in such broadcasts; though, to my mind, the German stations tend somewhat to over-accentuate the bass.

R. H. FLEMING.

Letchworth, Herts.

Electron-coupled Oscillator

THOSE readers who have constructed *The Wireless World* modulated oscillator and find frequency shift due to attenuator adjustments to be a disadvantage, may care to try the modification shown in the accompanying diagram. I find this arrangement is quite satisfactory.

The operating potentials are adjusted for maximum stability at all settings of the attenuator. This is conveniently done (in the absence of a stable wavemeter) by tuning the oscillator to "zero beat" with a broadcast station, using an ordinary broadcast receiver as the detector, then varying the attenuator and observing the difference in the beat note. Screen and plate voltages are adjusted to give minimum shift.

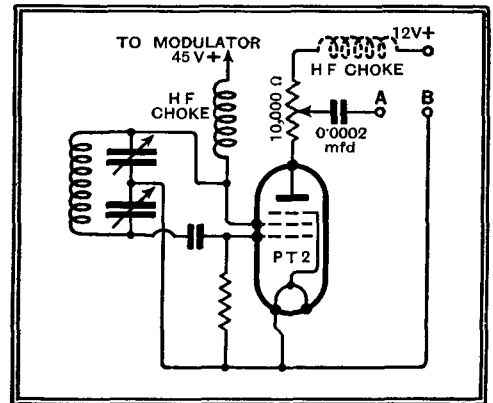

Suggested modification to *The Wireless World* Modulated Oscillator.

Using a Marconi PT2 I found voltages as marked on the diagram to be satisfactory.

It may be sometimes desirable to include an HF choke in series with the attenuator as shown by dotted lines in the diagram.

R. E. BLAKEY, D.Sc. (Eng.).

London, N.W.9.

Uses for P.A. Equipment

IT often happens in a big college that senior students are at times confined to their rooms or even to bed for a few days on account of illness or a small accident. It may happen that an important or very interesting lecture may be missed during this time. I see here a very interesting and useful application for a small P.A.E.

My idea is to have all the lecture halls wired and fitted with wall sockets into which a microphone (that described some months ago in *The Wireless World* seems to me suitable) placed before the professor, may be plugged. One or two rooms in the sick ward or infirmary are connected to this wiring. A small amplifier, with power equipment taken from a mains socket in the room, has its input plugged into the microphone wiring system, and the amplifier feeds one or more loud speakers.

I am anxious to know if such an equipment could be so simplified as to have all

the amplifying and power parts of the system concentrated at the receiving end, leaving nothing but the microphone and its leads at the transmitting end. The maximum distance from any lecture hall to receiving rooms being up to about 100 yards.

Would it also be possible to dispense entirely with accumulators or batteries for the polarising current of the microphone and substitute a metal rectifier with an efficient smoothing filter circuit?

This last point, although not essential, would be a great boon, as the apparatus would always be ready for use at a minute's notice, and no technical knowledge would be required to put the system into immediate operation.

Jersey. (REV.) G. H. J. HORANS.

HT Supply

WITH regard to the recent correspondence on HT supply for battery sets, I should like to mention one method which offers potentialities as yet insufficiently explored by our manufacturers. I refer to the vibratory generator, which is now being used extensively by car radio manufacturers, especially in America.

If anyone doubts the ability of this type of unit to give sufficient power, let him try (say) one of the latest model Philco car equipments, and I think he will be speedily convinced that he is wrong.

Surely this type of unit is the solution for the "battery man" who complains that he cannot get life-like quality because of the prohibitive cost of power from HT dry batteries.

I don't doubt the efficiency of HT accumulators (of either the lead-acid or the Milnes type), but why have two batteries when one will do equally well? Merely an additional necessary source of supply to give out when one wants to hear that *particular* programme!

I see no reason why the vibratory generator should not be made for 2-volt input. An output of about four watts should give ample supply for a reasonable quality set.

"Jumping" a figure of 60 per cent. efficiency for the generator gives an input of approximately 7 watts, which with 2 watts for filaments of the radio gives a discharge of $4\frac{1}{2}$ amps. from the 2-volt battery—well within the capacity of a 60 ampere-hour accumulator.

Let us hear what the research departments of our radio manufacturers have to say on the matter. B. MACQUILLAN.

Dublin.

Land Lines

MAY I make a modest rejoinder to Mr. Hartley's exuberant outburst in the issue of November 8th anent "land lines"?

As one whose business is connected with the installation of programme circuit carrying cables and their associated loading coils, it is a little mortifying to find our efforts (and in bad weather they *are* efforts, Mr. Hartley!) relegated to ignominious oblivion with the resounding epithet of "lousy."

The overall performance of cable *plus* repeaters will, I am reasonably led to believe, bear inspection up to about 7,000 c/s. Requirements in the matter of crosstalk level are very stringent, necessitating thorough screening throughout.

However, research has produced the "co-axial cable," and it is not improbable that this type will afford the perfect solution of the land-line problem.

Ferrybridge, J. L. GREATOREX.
Yorks.

Below 100 Metres

How Stations Come In

RECEPTION conditions during November have generally been good, especially during daylight. Even during the late evenings conditions have not drifted so noticeably in favour of the *long* short waves (50-70 metres) as was the case about this time last year.

This change is undoubtedly connected with a change in solar activity, and up to the time of writing at least one group of sunspots has been visible on any day since the beginning of October. This condition certainly did not hold last winter, when they were conspicuous by their absence.

There is also little doubt that the extraordinary activity on the 10- and 5-metre amateur wavebands is also partly attributable to this increase in sunspot activity.

Whilst on this point I should like to sound a note of warning to a few over-enthusiastic amateurs and others who, because of the present success of 10-metre transmissions, not realising that they may be very temporary in nature, appear to feel that the commercial and broadcasting stations should immediately make full use of these short waves for day-to-day services.

The fact is, the shortest practical wave is generally not the optimum wave for general communication, and what we shall probably see is the commercial station forsaking the 17-metre daylight waves and coming down to 12-14-metres for daylight working as we approach the sunspot maximum years of 1938-39.

Returning to an actual survey of conditions during November, we find that W8XX on 13.93 metres was audible practically every day up to November 23rd, reception

generally peaking between 13.00 and 14.00 G.M.T., at which latter time this station goes off the air.

W3XAL on 16.87 metres has also been a consistently good, though not a very strong, signal most afternoons, but, on the other hand, W2XE, the Columbia system station at Wayne, which has recently commenced operation on 16.89 metres, between 16.00 and 18.00 G.M.T., has not yet been identified. Zeesen, DJE, also uses this channel until 16.30 G.M.T., which is apt to complicate matters.

Longer Waves

Conditions in the 19-metre band have been fair, too; W2XAD, who has been good during the recent "Five Hours Back" programmes, as well as during the relay of the "Yale-Harvard" match on Saturday, November 23rd, is closely followed in merit by W8XX and W2XE.

During daylight, DJB, Zeesen, has been his usual local station signal in this band, accompanied on occasions by DJL, an experimental transmitter on the next channel to the Vatican HVJ (19.80 metres, 15,110 kc/s.). Sometimes DJL suffered from Morse interference from EPB, Teheran.

VQ7LO, Nairobi, on 49.31 metres, was a good signal, too, on Saturday, November 23rd, at 18.00 G.M.T. onwards, and on Sunday evening, November 24th, PMN, Java, on 29.25 metres was also at local station strength, relaying the NIROM (Dutch East Indies Broadcasting Company) physical jerks programme, followed by an excellent gramophone recital with English records. The strength of this station is remarkable considering that the power is only 3 kW. It is understood that Bandoeng will start a regular service in 1936.

On the 31-metre band W2XAF, on 31.48 metres, has been the best distant signal. The Europeans, LKJI, DJA, DJN, have been local station signals in daylight.

On 31.28 metres VK2ME has been very good most Sunday afternoons, during which period it uses an array directional on England. Sometimes this reception has been worried by a harmonic from Poste Parisien.

Relatively weak stations have been W3XAU, VK3LR, Lyndhurst (at breakfast time), and W1XAZ.

Rio de Janeiro, PR5F, has been generally good, but not of great programme value. Havana, COCH, has also been heard at weak strength but very well modulated on 31.8 metres. Rome, like the poor, is always with us on 31.13 metres.

Whilst very strong signals have been obtained from the U.S. commercials in the neighbourhood of 40-50 metres, the 49-metre band has been relatively poor from the programme value point of view. The best signals, apart from VQ7LO and locals, having been CRCX, Bowmanville.

Vienna, OER2, on 49.42 metres, has been responsible for some good-quality good-programme-value transmissions, whilst about the strongest dx signal is the "noise" which occupies the 6,060 kc/s channel, 49.5 metres, round about 23.00 G.M.T. onwards.

Many South American stations have been heard weakly, and are still a delight to the dx enthusiast—but not to those who aim at programme value! More will be said about these next time.

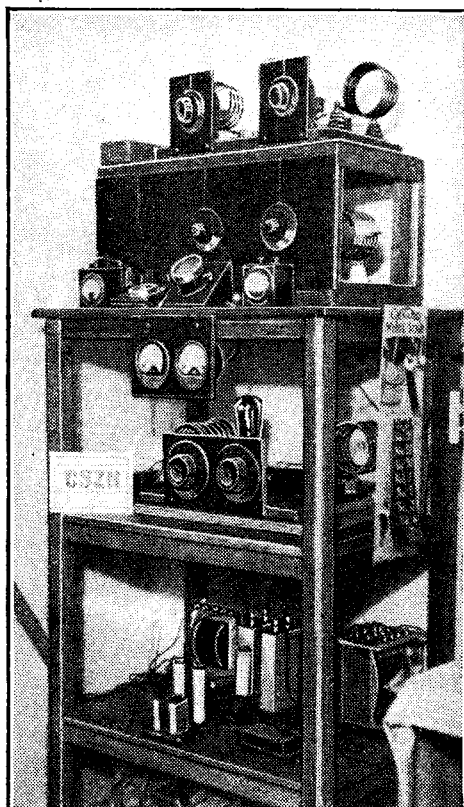

The receiver and monitor-wavemeter at G5ZN, owned by Mr. P. Nicoll, "Clints," 35, Reedley Road, Burnley, Lancs. testing regularly on the 84, 42 and 21-metre bands.

Random Radiations

By "DIALLIST"

Wireless Sets and Railways

IN my note under this title in the issue of November 15th I am afraid I was rather misleading, as I may have given readers the idea that a concession had been made by the railways in respect of returned sets, whereas the true position is that it has been made clear that in the case of trade despatches wireless receiving sets in approved packing are accepted for carriage by the railways at company's risk

- (1) When sent from manufacturers.
- (2) When sent from factors or dealers in the original packing, not having been unpacked.
- (3) When new and, although having been unpacked, are forwarded by factors or dealers provided a declaration is given on the consignment note or (in the case of passenger train traffic) on the label that the receiver is repacked in the original packing in good condition.

It is an arrangement which the railways are applying to any manufacturers and their agents whose method of packing is approved by the Railway Clearing House, and is not confined to the goods of particular radio manufacturers.

My comments on damage occurring in transit referred to the cases where sets are returned to manufacturers by rail without proper packing, or where the approved containers have been used but the sets have not been correctly packed in them, which is, of course, inviting risk of damage.

A Listeners' Association

THERE is a suggestion being put forward that there should be some kind of "Listeners' Association" to act as a connecting link between the broadcaster and the broadcastee. The B.B.C. was recently approached on the subject, but did not display any remarkable enthusiasm. Those who brought forward the proposal for a listeners' association made, I think, one big mistake in suggesting that the expenses in connection with it should be met by a grant from the licence revenue. This proposal the B.B.C. flatly declined to accept—and no wonder!

If such an association were worth forming, its members would surely not object to a small annual subscription to defray the costs of running it. There are already too many calls on the revenue from receiving licences, and the B.B.C.'s share must be increased rather than reduced.

Would It Work?

If a listeners' association were widely supported by listeners of all kinds it might do some very good work by keeping those responsible for programme-building closely in touch with the likes and dislikes of the public. It is probable, too, that it would have valuable suggestions to make from time to time for new features in the programmes. But there is always the danger that, however big its membership, the actual running of an association of this kind may get into the hands of a small coterie of cranks, and that sort of thing is fatal. For its labours to be of any real value the association as a whole, and its working committee in particular, would have to be

thoroughly representative of listeners at large—and then there is the danger that we might get programmes always in keeping with the wishes of the majority.

Aerials and Interference

DESPITE all that has been written about the anti-interference aerial, I find that very few ordinary listeners have ever heard of it. I came across a rather interesting case the other day. A friend had bought one of the most expensive radiograms going which had been installed in his flat, one of a large block. Interference turned out to be so bad that the apparatus proved practically useless for reception even of the local station. Then someone told him about the possibilities of the anti-interference aerial and the disturbance suppressor. He had an A.-I. aerial fitted, and to his complete surprise found that interference had simply vanished.

Such aerials are now being fitted as a matter of course to many of the latest blocks of flats and they are proving most satisfactory. From a common aerial a considerable number of interference-free transmission lines are taken and the users neither suffer from noisy reception nor interference at all with the working of one another's sets.

Shorter Waves for Empire Broadcasts

THE B.B.C. intends to make experimental Empire transmissions quite soon on wavelengths as short as 11.49 metres. At present the lowest wavelength in use at Daventry is that of GSG, which works on 16.86 metres. So great, however, has been the success of amateurs in long-distance transmissions on wavelengths between 10 and 12 metres that the B.B.C. anticipates remarkable results from the shorter wavelength. When the meeting of the Technical Commission of the International Broadcasting Union, which will take place in Paris next February, was first mooted it was probably not realised that the experts concerned might be called upon to allocate channels on wavelengths right down to 10 metres; but our own country is by no means the only one in which broadcasting authorities have lately seen the possibilities of these very short waves, and it is certain that others will put in claims for exclusive channels. The International Telecommunication Conference will be held at Cairo in 1938; the whole question of short-wave broadcasting will be thoroughly discussed, and the Conference should be particularly interesting, for the very short waves should then be at their best, since 1938-1939 should see the sunspot maximum period.

A Question of Names

In the preceding paragraph I have used the term "very short waves" for those between 10 and 16 metres for lack of anything better. The ultra-short waves are usually taken as extending from 10 metres downwards, but the band between 10 metres and 16 metres has characteristics of its own, and certainly seems to demand an official name. Perhaps the

February Conference will manage to coin one. Meantime the man in the street is somewhat confused over the terms ultra-short, short, medium and long waves. Many people, I find, refer to wavelengths below 100 metres as ultra-short. This confusion has arisen owing to the action of some manufacturers, who a year or two ago labelled the two positions of their wave-change switch Long and Short instead of Long and Medium. Non-technical people who have used such sets have got into the habit of thinking of the medium waveband as the short waves; when, therefore, they purchase all-wave sets they are apt to speak of the real short waves as the ultra-shorts. I do hope that manufacturers won't further complicate the position by labelling the lowest range of all-wave sets which cover the short waves in two or more bands the ultra-shorts. I am afraid, though, that something of the kind may happen, for I have already found this term applied to the band between 16 and 25 metres in the "book of words" accompanying one set. Pretty hard on the unfortunate man in the street when television arrives on the genuine ultra-shorts!

Would You Believe It?

YOU really can't wonder that some wireless sets develop defects when you consider the way in which some of them are treated. An almost incredible instance of ill-usage came my way a week or two ago, though I have no doubt other sets are mishandled in much the same way. From a correspondent I heard that a set of well-known make had started to give trouble within a week of its purchase. He had called in the service man, who, after examining the apparatus, said that the speech coil of the loud speaker had gone wrong and must be replaced. This work was carried out, and, to my correspondent's astonishment and disgust, the trouble recurred almost at once. He was most indignant about it. Couldn't think how the makers had the impudence to continue advertising a set that was so utterly unreliable, and so on, and so on.

When the complaint was investigated it was found that the set lived permanently on a table which was right in front of a large fire and less than six feet from it! The heat to which it was subjected for many hours every day was quite sufficient to account for the warping of the coil. I must say, though, that I am surprised that the service man didn't spot the cause of the trouble when he first saw the set in this quaint position.

Mystery Ray Claims

YET another claim has recently appeared of success with a ray that will stop the engines of aeroplanes or motor cars at quite a considerable distance. This time it is Mr. L. G. Anderson, an Australian, who intimates that the United States Navy Department tells him that they have tested out his invention and found it so promising that they have offered him a post in the Navy's Experimental Laboratory at Lakehurst. There certainly was a report from the United States that in the course of experiments internal-combustion engines had been stopped by means of a radiation at ranges up to ten miles. At the same time, I must say that I view all such claims with a certain amount of scepticism, for metal shielding should protect engines effectively against any kind of "death ray."

SETS FOR THE HOME CONSTRUCTOR

Full Descriptions and Building Instructions in Back Numbers of the "Wireless World"

Blue Prints Available, Price 1/6 Each

THE PUSH-PULL QUALITY AMPLIFIER.—Four-valve resistance-coupled circuit for high quality distortionless reproduction of both broadcasting and gramophone records. Full description and constructional notes reprinted from three issues of the WIRELESS WORLD. Price 6d.

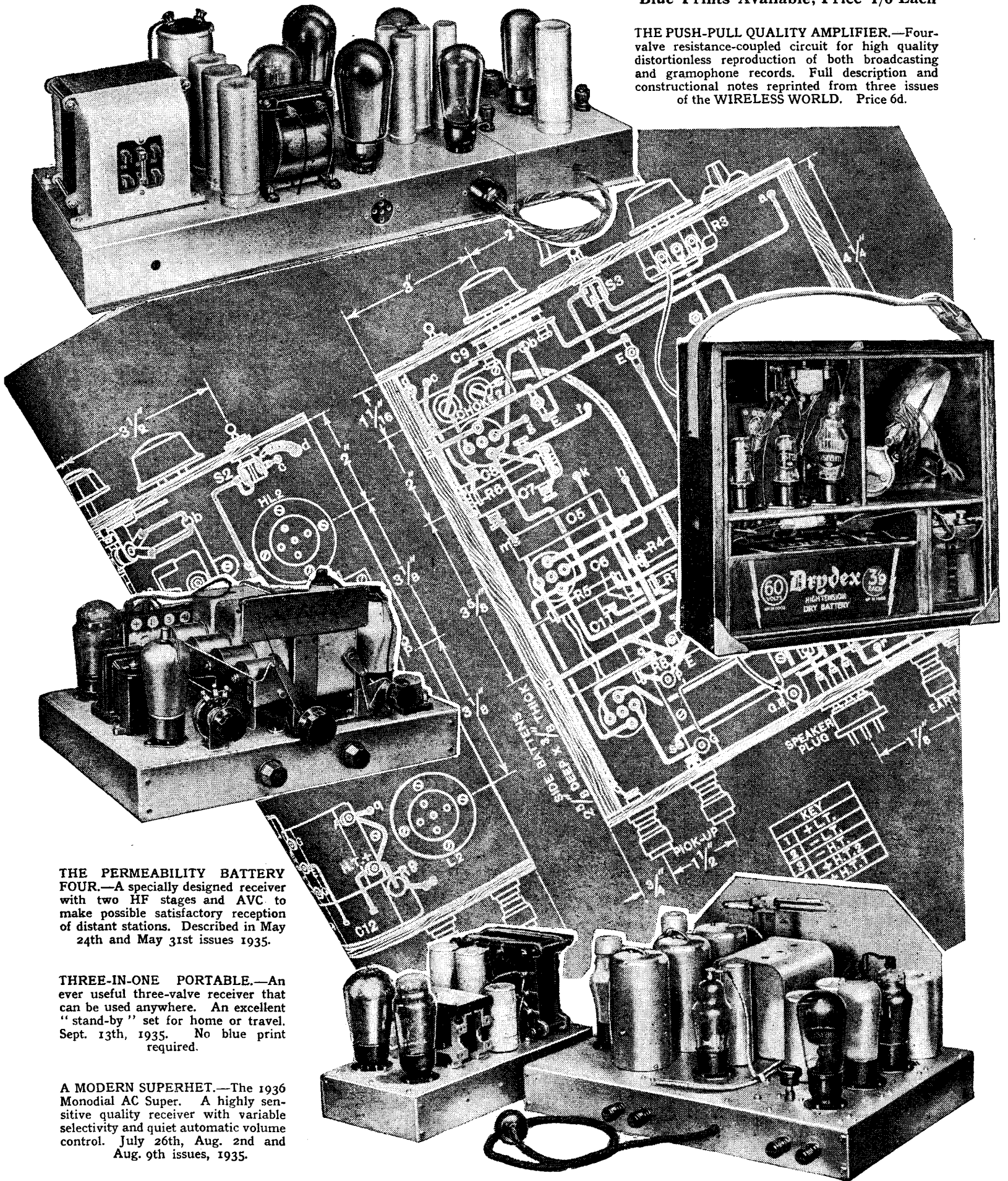

THE PERMEABILITY BATTERY FOUR.—A specially designed receiver with two HF stages and AVC to make possible satisfactory reception of distant stations. Described in May 24th and May 31st issues 1935.

THREE-IN-ONE PORTABLE.—An ever useful three-valve receiver that can be used anywhere. An excellent "stand-by" set for home or travel. Sept. 13th, 1935. No blue print required.

A MODERN SUPERHET.—The 1936 Monodial AC Super. A highly sensitive quality receiver with variable selectivity and quiet automatic volume control. July 26th, Aug. 2nd and Aug. 9th issues, 1935.

PRINCIPAL BROADCASTING STATIONS OF EUROPE

Arranged in Order of Frequency and Wavelength

(This list is included in the first issue of each month. Stations with an aerial power of 50 kW. and above in heavy type)

Station.	kc/s.	Tuning Positions.	Metres.	kW.	Station.	kc/s.	Tuning Positions.	Metres.	kW.
Kaunas (Lithuania)	155		1935	7	Graz (Austria). (<i>Relays Vienna</i>)	886		338.6	7
Brazov (Romania)	160		1875	150	Helsinki (Finland)	895		335.2	10
Kootwijk (Holland) (<i>Relays Hilversum</i>) (10 kW. till 2.40 p.m.)	160		1875	100	Hamburg (Germany)	904		331.9	100
Lahti (Finland)	166		1807	40	Toulouse (Radio Toulouse) (France)	913		328.6	60
Moscow, No. 1, RW1 (Komintern) (U.S.S.R.)	174		1724	500	Brno (Czechoslovakia)	922		325.4	32
Paris (Radio Paris) (France)	182		1648	80	Brussels, No. 2 (Belgium). (<i>Flemish Prog'mme</i>)	932		321.9	15
Istanbul (Turkey)	187.5		1600	5	Algiers, P.T.T. (Radio Alger) (Algeria)	941		318.8	12
Berlin (Deutschlandsender Zeesen) (Germany)	191		1571	60	Göteborg (Sweden). (<i>Relays Stockholm</i>)	941		318.8	10
Droitwich	200		1500	150	Breslau (Germany)	950		315.8	100
Minsk, RW10 (U.S.S.R.)	208		1442	35	Paris (Poste Parisien) (France)	959		312.8	60
Reykjavik (Iceland)	208		1442	16	Odessa (U.S.S.R.)	968		309.9	10
Motala (Sweden). (<i>Relays Stockholm</i>)	216		1389	150	Belfast	977		307.1	1
Novosibirsk, RW76 (U.S.S.R.)	217.5		1379	100	Genoa (Italy). (<i>Relays Milan</i>)	986		304.3	10
Warsaw, No. 1 (Raszyn) (Poland)	224		1339	120	Torun (Poland)	986		304.3	24
Luxembourg	230		1304	150	Hilversum (Holland). (15 kW. till 4.40 p.m.)	995		301.5	60
Ankara (Turkey)	230		1304	7	Bratislava (Czechoslovakia)	1004		298.8	13.5
Kharkov, RW20 (U.S.S.R.)	232		1293	20	Midland Regional (Droitwich)	1013		296.2	50
Kalundborg (Denmark)	238		1261	60	Barcelona, EAJ15 (Radio Asociación) (Spain)	1022		293.5	3
Leningrad, RW53 (Kolpino) (U.S.S.R.)	245		1224	100	Cracow (Poland)	1022		293.5	2
Tashkent, RW11 (U.S.S.R.)	256.4		1170	25	Heilsberg (Königsberg Ermland) (Germany)	1031		291	100
Oslo (Norway)	260		1153.8	60	Pareda (Radio Club Português) (Portugal)	1031		291	5
Moscow, No. 2, RW49 (Stchekovo) (U.S.S.R.)	271		1107	100	Leningrad, No. 2, RW70 (U.S.S.R.)	1040		288.5	10
Tiflis, RW7 (U.S.S.R.)	280		1071.4	35	Rennes-Bretagne, P.T.T. (Thourle) (France)	1040		288.5	120
Finmark (Norway)	355		845.1	10	Scottish National (Falkirk)	1050		285.7	50
Rostov-on-Don, RW12 (U.S.S.R.)	355		845.1	20	Bari (Italy)	1059		283.3	20
Budapest, No. 2 (Hungary)	359.5		834.5	20	Paris (Radio Cité) (France)	1068		280.9	0.8
Sverdlovsk, RW5 (U.S.S.R.)	375		800	50	Tiraspol, RW57 (U.S.S.R.)	1068		280.9	4
Geneva (Switzerland). (<i>Relays Sottens</i>)	401		748	1.3	Bordeaux, P.T.T. (Lafayette) (France)	1077		278.6	50
Moscow, No. 3 (RCZ) (U.S.S.R.)	401		748	100	Zagreb (Yugoslavia)	1086		276.2	0.7
Voroneje, RW25 (U.S.S.R.)	413.5		726	10	Falun (Sweden)	1086		276.2	2
Oulu (Finland)	431		696	1.2	Madrid, EAJ7 (Union Radio) (Spain)	1095		274	10
Ufa, RW22 (U.S.S.R.)	436		688	10	Madona (Latvia)	1104		271.7	50
Hamar (Norway). (<i>Relays Oslo</i>)	519		578	0.7	Naples (Italy). (<i>Relays Rome</i>)	1104		271.7	1.5
Innsbruck (Austria). (<i>Relays Vienna</i>)	519		578	1	Moravska-Ostrava (Czechoslovakia)	1113		269.5	11.2
Ljubljana (Yugoslavia)	527		569.3	5	Fécamp (Radio Normandie) (France)	1113		269.5	5
Viipuri (Finland)	527		569.3	10	Alexandria (Egypt)	1122		267.4	0.25
Bolzano (Italy)	536		559.7	1	Newcastle	1122		267.4	1
Wilno (Poland)	536		559.7	16	Nyiregyhaza (Hungary)	1122		267.4	6.2
Budapest, No. 1 (Hungary)	546		549.5	120	Hörby (Sweden). (<i>Relays Stockholm</i>)	1131		265.3	10
Beromünster (Switzerland)	556		539.6	100	Turin, No. 1 (Italy). (<i>Relays Milan</i>)	1140		263.2	7
Athlone (Irish Free State)	565		531	60	London National (Brookmans Park)	1149		261.1	20
Palermo (Italy)	565		531	4	North National (Slaitwaite)	1149		261.1	20
Stuttgart (Mühlacker) (Germany)	574		522.6	100	West National (Washford Cross)	1149		261.1	20
Grenoble, P.T.T. (France)	583		514.6	15	Kosice (Czechoslovakia). (<i>Relays Prague</i>)	1158		259.1	2.6
Riga (Latvia)	583		514.6	15	Monte Ceneri (Switzerland)	1167		257.1	15
Vienna (Bisamberg) (Austria)	592		506.8	100	Copenhagen (Denmark). (<i>Relays Kalundborg</i>)	1176		255.1	10
Rabat (Radio Maroc) (Morocco)	601		499.2	25	Kharkov, No. 2, RW4 (U.S.S.R.)	1185		253.2	10
Sundsvall (Sweden). (<i>Relays Stockholm</i>)	601		499.2	10	Nice (La Brague) (France)	1185		253.2	60
Florence (Italy). (<i>Relays Milan</i>)	610		491.8	20	Frankfurt (Germany)	1195		251	25
Cairo (Abu Zabal) (Egypt)	620		483.9	20	Prague, No. 2 (Czechoslovakia)	1204		249.2	5
Brussels, No. 1 (Belgium). (<i>French Programme</i>)	620		483.9	15	Lille, P.T.T. (Camphin) (France)	1213		247.3	60
Lisbon (Bacarena) (Portugal)	629		476.9	20	Trieste (Italy)	1222		245.0	10
Trøndelag (Norway)	629		476.9	20	Gleititz (Germany). (<i>Relays Breslau</i>)	1231		243.7	5
Prague, No. 1 (Czechoslovakia)	638		470.2	120	Cork (Irish Free State). (<i>Relays Athlone</i>)	1240		241.9	1
Lyons, P.T.T. (La Doua Tramoyes) (France)	648		463	90	Swedish Relay Stations	1240		241.9	1
Cologne (Langenberg) (Germany)	658		455.9	100	Juan-les-Pins (Radio Côte d'Azur) (France)	1249		240.2	0.8
North Regional (Slaitwaite)	668		449.1	50	Kuldiga (Latvia)	1258		238.5	10
Sottens (Radio Suisse Romande) (Switzerland)	677		443.1	25	Rome, No. 3 (Italy)	1258		238.5	1
Belgrade (Yugoslavia)	686		437.3	2.5	San Sebastian (Spain)	1258		238.5	1
Paris, P.T.T. (Palaiseau Villebon) (France)	695		431.7	120	Nürnberg and Augsburg (Germany). (<i>Relays Munich</i>)	1267		236.8	2
Stockholm (Sweden)	704		426.1	55	Christiansand and Stavanger (Norway)	1276		235.1	0.5
Rome, No. 1 (Italy)	713		420.8	50	Dresden (Germany). (<i>Relays Leipzig</i>)	1285		233.5	0.25
Kiev, RW9 (U.S.S.R.)	722		415.5	36	Aberdeen	1285		233.5	1
Tallinn (Esthonia)	731		410.4	20	Austrian Relay Stations	1294		231.8	0.5
Madrid, EAJ2 (Radio España) (Spain)	731		410.4	3	Danzig. (<i>Relays Königsberg</i>)	1303		230.2	0.5
Seville (Spain)	731		410.4	5.5	Swedish Relay Stations	1312		228.7	1.25
Munich (Germany)	740		405.4	100	Magyarovar (Hungary)	1321		227.1	1.25
Marseilles, P.T.T. (Reator) (France)	749		400.5	90	German Relay Stations	1330		225.6	2
Katowice (Poland)	758		395.8	12	Montpellier, P.T.T. (France)	1339		224	0.8
Scottish Regional (Falkirk)	767		391.1	50	Lodz (Poland)	1339		224	1.7
Toulouse, P.T.T. (Muret) (France)	776		386.6	120	Dublin (Irish Free State). (<i>Relays Athlone</i>)	1348		222.6	0.5
Leipzig (Germany)	785		382.2	120	Milan, No. 2 (Italy). (<i>Relays Rome</i>)	1357		221.1	4
Barcelona, EAJ1 (Spain)	795		377.4	7.5	Turin, No. 2 (Italy). (<i>Relays Rome</i>)	1357		221.1	0.2
Lwow (Poland)	795		377.4	16	Basle and Berne (Switzerland)	1375		218.2	0.5
West Regional (Washford Cross)	804		373.1	50	Warsaw, No. 2 (Poland)	1384		216.8	2
Milan (Italy)	814		368.6	50	Lyons (Radio Lyons) (France)	1393		215.4	25
Bucharest (Romania)	823		364.5	12	Tampere (Finland)	1420		211.3	0.7
Moscow, No. 4, RW39 (Stalina) (U.S.S.R.)	832		360.6	100	Miskolc (Hungary)	1438		208.6	1.25
Berlin (Funkstunde Tegel) (Germany)	841		356.7	100	Paris (Eiffel Tower) (France)	1456		206	20
Bergen (Norway)	850		352.9	1	Pecs (Hungary)	1465		204.8	1.25
Sofia (Bulgaria)	850		352.9	50	Bournemouth	1474		203.5	1
Valencia (Spain)	850		352.9	3	Plymouth	1474		203.5	0.3
Simferopol, RW52 (U.S.S.R.)	859		349.2	10	International Common Wave	1492		201.1	0.5
Strasbourg, P.T.T. (France)	859		349.2	100	International Common Wave	1500		200	0.25
Poznan (Poland)	868		345.6	16	Liepāja (Latvia)	1737		173	0.1
London Regional (Brookmans Park)	877		342.1	50					

NOTE.—Since the publication of the previous list alterations have been made to the following stations: Lyons (France), Paris, Radio Cité (France), Fécamp (France), Juan-les-Pins (France), Montpellier (France), Milan (Italy).

SHORT-WAVE STATIONS OF THE WORLD

Arranged in Order of Wavelength and Frequency

(N.B.—Times of Transmission given in parentheses are approximate only and represent G.M.T.)

Table with columns: Metres, kc/s, Call Sign, Station, Tuning Positions, Metres, kc/s, Call Sign, Station, Tuning Positions. Lists various short-wave stations worldwide with their frequencies and call signs.

Recent Inventions

Brief descriptions of the more interesting radio devices and improvements issued as patents will be included in this section

PIEZO-ELECTRIC SPEAKER

A PIEZO-ELECTRIC drive for a loud speaker consists of four crystal units secured together along their edges. Each unit is formed of a pair of superposed plates of Rochelle salt cut normal to the electrical axis of the mother crystal. Electrodes are inserted between adjacent faces, and at each of the outer faces, and are connected in parallel.

Patent issued to *Boonton Research Corporation*. Convention date (U.S.A.) 12th December, 1933, No. 430025.

DIRECTIONAL WIRELESS

IT is usual in short-wave directional systems to use a parabolic or hyperbolic screen to focus the waves into a beam. According to the invention a reflector having a focal length which is small by comparison with the working wave length is used, and the cusp portion of it, i.e. the part having the largest curvature, is cut away and replaced by an auxiliary curved surface which is so shaped that the reflected waves fall on to the oscillating circuit in correct phase. The auxiliary surface may, for instance, be part of the glass wall of the transmitting or receiving valve, the part in question being coated on the inner or outer surface with a metallic reflecting layer.

Patent issued to *J. Pintsch, Akt.* Convention date (Germany) 9th March, 1934, No. 430646.

MODULATING SYSTEM

IN ordinary methods of modulation, the amplitude and power of the carrier-wave are usually unnecessarily large in comparison

it is possible to modulate the carrier-wave substantially up to 100 per cent. throughout the transmission.

Patent issued to *J. J. Pohjanpalo*. Application date 20th August, 1934, No. 430210.

PHOTO-ELECTRIC CATHODES

A SENSITIVE-OXIDE layer for a photo-electric cell is formed by using an alkaline-earth metal, such as calcium, as a cathode placed some distance away from the surface to be coated, and then passing a discharge current from it to that surface through an atmosphere of oxygen. The operation is carried out in a glass bulb containing oxygen at a pressure of about 0.01 mm.

Patent issued to *N. V. Philips' Gloeilampenfabrieken*. Convention date (Germany) 26th March, 1934, No. 430224.

TUNING

THE tuning circuits are arranged so as to select and pass on the signal carrier-wave together with only one or other of the associated side-bands, thus cutting down the frequency-band to approximately half that usually required. This in turn serves to eliminate undesired signals and so minimises interference. The particular side-band to be received can be selected at will, so that if one side-band happens to coincide with an interfering signal a slight adjustment changes the tuning to the other side-band. In operation the signal-selecting circuits are adjusted to a point where the desired signal carrier is located at one edge or other of the band permitted to pass through. In

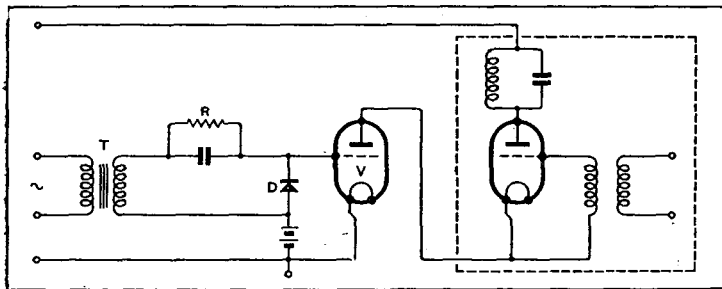

A new modulating circuit.

with the radiated side-bands. To overcome this a rectifier *D* is used to rectify the signal, and both the rectified signal-voltage across the resistance *R* and the original signal-voltage from the transformer *T* are applied to the grid of the modulator valve *V*, which, as shown, is in series with the carrier-wave amplifier *V1*. The carrier-wave is thus modulated, and simultaneously is varied in amplitude according to the applied signal intensity. In this way it

other words, instead of being tuned symmetrically to the carrier, as usual, the input circuits are tuned to the mid-frequency of the side-band being utilised. As a further feature, the audible response of the receiver is increased to a sharp maximum at the correct setting, at which a positive indication is given.

Patent issued to *Hazeltine Corporation*. Convention date (U.S.A.) 3rd October, 1933, No. 430787.

COMBINED TRANSMITTER AND RECEIVER

THE circuit is shown in the Figure, the chief features of interest being the coupling-circuit to the dipole aerial *A* and the change-over switch *S*. The latter is thrown on the centre contacts for transmission, so that the anode of the carrier-wave generator *V* is connected to the anode of valve *V1*, whilst the grid-leak *R* is earthed. The microphone *M* then feeds the grid circuit of valve *V1*, which acts as a modulator valve. The headphones *P* serve for monitoring, and also as a modulating choke. On the other side of switch *S* the circuits are set for reception. The valve *V* then acts

which is advanced two frames at a time by the usual Maltese-cross drive. The "doubled" film is then developed and projected at normal speed for observation.

Patent issued to *J. L. Baird and Baird Television, Ltd.* Application date 25th September, 1933, No. 430900.

TUNING CONTROL

IN an ordinary superhet set, the local-oscillator and tuned-input or preselector circuits are ganged together so as to produce a fixed intermediary frequency. When the set is slightly out of tune with the incoming signal it produces a beat frequency with the local oscillator which is different from

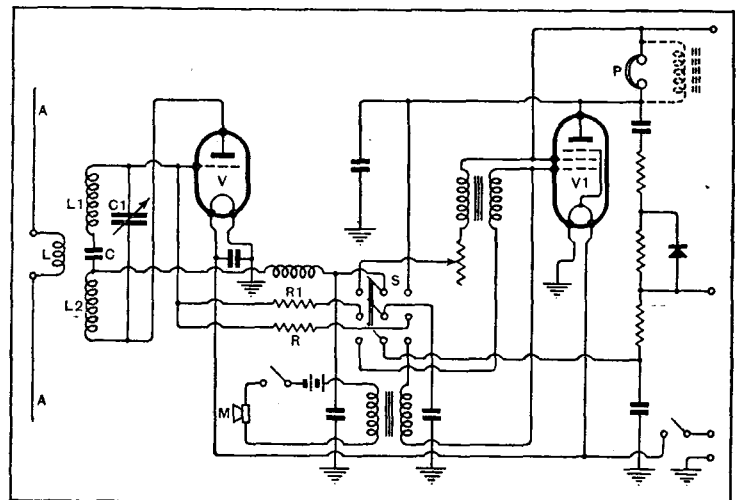

Theoretical circuit of the Hermes transceiver.

as a super-regenerative detector, the grid-leak *R1* being substituted for the resistance *R*, whilst the valve *V1* becomes a low-frequency amplifier. The aerial coil *L* is coupled to the input through coils *L1*, *L2* in series with a condenser *C*, the circuit as a whole being tuned by the condenser *C1*.

Patent issued to *L. W. Hermes and L. Hermes*. Application date 23rd March, 1935, No. 430408.

TELEVISION

THE practice of transmitting high-definition television pictures at the rate of 25 per second is based upon the necessity of avoiding "flicker." An apparent continuity of quite rapid motion in the received picture can be maintained by using only half this repetition frequency, or 12½ frames a second. According to the invention, this lower frame frequency is used in transmission, so as to reduce the side-band spread in the ether, and provision is made at the receiving end to duplicate each picture as it comes in, so as to double the number actually thrown on the receiving screen, thus avoiding the flicker effect.

The incoming picture signals are applied to a light-valve, as usual, but the emergency ray is split into two and thrown by the scanning-disc over two adjacent "frames" on a cinema film,

the required IF frequency. This second frequency is utilised, according to the invention, as a "lock control" to ensure that no signal can get through to the loud-speaker unless the circuits are accurately in tune. A second local oscillator is coupled to the last IF stage, and is utilised to produce a low-frequency beat so long as the set is off-tune. The resulting rectified current is used to throw the second detector out of action, so that no signals can pass through.

Patent issued to *E. K. Cole, Ltd.; A. W. Martin and H. Hunt*. Application date 3rd February, 1934, No. 431006.

SCREEN-GRID AMPLIFIER

WHEN amplifying very high frequencies there is a residual capacity coupling from anode to control grid even in the case of a screen-grid valve. In order to eliminate it a direct connection is taken from an intermediate point along the length of the screening grid inside the glass bulb, to a point at cathode potential outside the bulb. The tapping point on the screening grid is so chosen that electrostatic and magnetic coupling between the two grids is substantially balanced out.

Patent issued to *N. V. Philips, Gloeilampenfabrieken*. Convention date (Germany) 7th April, 1933, No. 431180.



No. 850.

FRIDAY, DECEMBER 13TH, 1935.

VOL. XXXVII.

No. 24.

Proprietors : ILIFFE & SONS LTD.

Editor :
HUGH S. POCOCK.

Editorial,
Advertising and Publishing Offices :
DORSET HOUSE, STAMFORD STREET,
LONDON, S.E.1.

Telephone: Waterloo 3333 (50 lines).
Telegrams: "Ethaworld, Sedist, London."

COVENTRY: Hertford Street.
Telegrams: "Autocar, Coventry." Telephone: 5210 Coventry.

BIRMINGHAM:
Guildhall Buildings, Navigation Street, 2.
Telegrams: "Autopress, Birmingham." Telephone: 2971 Midland (4 lines).

MANCHESTER: 260, Deansgate, 3.
Telegrams: "Iliffe, Manchester." Telephone: Blackfriars 4412 (4 lines).

GLASGOW: 26B, Renfield Street, C.2.
Telegrams: "Iliffe, Glasgow." Telephone: Central 4857.

PUBLISHED WEEKLY. ENTERED AS SECOND
CLASS MATTER AT NEW YORK, N.Y.

Subscription Rates :
Home, £1 rs. 8d. ; Canada, £1 rs. 8d. ; other
countries, £1 3s. 10d. per annum.

*As many of the circuits and apparatus described in these
pages are covered by patents, readers are advised, before
making use of them, to satisfy themselves that they would
not be infringing patents.*

CONTENTS

	Page
<i>Editorial Comment</i>	609
<i>How Sensitive Need a Set Be?</i> ..	610
<i>Range of Five-metre Transmissions</i>	613
<i>Current Topics</i>	615
<i>Does Broadcasting Serve Britain?</i>	616
<i>Unbiased</i>	619
<i>Air King All-wave Receiver</i> ..	620
<i>Listeners' Guide for the Week</i> ..	622
<i>New Apparatus Reviewed</i> ..	624
<i>Broadcast Brevities</i> ..	625
<i>Hylvollstar All-wave Universal Ten</i>	626
<i>"Just think what Two can do"</i> ..	629
<i>Recent Inventions</i>	630

Editorial Comment

Telephone Listening

Alternative to the Loud Speaker

IT has often been suggested that if wireless telegraphy and wireless telephony had been invented first and had been succeeded by the invention of means to convey the same intelligence along wires for the telegraph and telephone services, we should probably have regarded communication by wire as the greater invention. The reason would be that it enabled point-to-point communication to be carried out without broadcasting the information to anyone who cared to listen-in, and also because the power required for the transmission would generally be less.

The same arguments can be put forward in regard to the wireless loud speaker in the home. The loud speaker was heralded as a wonderful improvement upon ordinary telephones because it enabled all the family to listen to broadcasting at the same time and without the discomfort and inconvenience of wearing headphones, which prevented one from moving about and doing other things to a background of broadcasting.

Circumstances have changed since loud speakers first came in and it seems as though telephones have much to recommend them to the consideration of listeners to-day.

Individual Tastes

The idea of having a set turned on continuously is not so popular as it used to be. Listeners are more inclined to discriminate and listen only when they can settle down in comfort and give their undivided attention to some item they really want to hear. Tastes differ even in the same family, so that it is seldom possible to have a set tuned to a programme which is equally welcome to every member of the household.

How much more logical it would seem to be if, by the more general use of telephones for reception in place of, or as an alternative to, the loud speaker, a programme could be listened to without disturbing other users of a room who may be engaged in different occupations. "Cathode Ray" in his contribution this week enlarges upon this idea, and we feel that it is a subject well worth consideration by listeners generally and by the set manufacturers who, at little additional cost and trouble, could provide plug sockets to enable phones to be used with any set, if desired, and make provision for disconnecting the loud speaker meanwhile.

There is no doubt that it is possible to concentrate much more easily on a programme when listening with headphones than it is with a loud speaker. Quality is very good and although not, perhaps, up to the standard of the best of modern loud speakers, there is no reason why telephones should not be improved. After all, they have not received anything like the same attention from designers for the reason that their popularity waned in favour of the loud speaker comparatively soon after broadcasting started. With some improvement in reproduction quality and a little attention to the most comfortable arrangement for wearing them, telephones might easily return to favour, even to an extent where their popularity rivalled that of the present ubiquitous loud speaker.

How Sensitive

THE LIMIT IMPOSED BY NOISE

By A. L. M. SOWERBY, M.Sc.



ALL too often sensitivity is assessed on a vague and hopelessly misleading basis. Confusion on this score seems quite unnecessary; this article shows that the sensitivity of typical circuits can be estimated quantitatively with fair accuracy, both in relation to each other and to noise levels of various intensities. Thus the choice of a receiver to satisfy definite requirements under given conditions is greatly facilitated.

THE degree of sensitivity required in a receiver depends on a good many factors. That it should be high enough to bring in all the stations that the listener wants to hear goes without saying—but that, unfortunately, is not a very exact definition.

Some few listeners are content to hear the local stations only; unless they live a long way from their nearest transmitter, or are compelled to use a very inefficient aerial, the sensitivity they require is quite low. Others live in districts where the level of man-made noise is high; in consequence they are debarred from listening to stations of low field strength, the high amplification necessary for these simultaneously bringing up the interference sufficiently either to drown out the programme or to overlay it with so much noise that there is no pleasure in listening to it.

Sensitivity—and Selectivity to Match

The selectivity of the set is a factor, too. Quite moderate sensitivity enables a set to bring in all the more powerful stations; since other stations near in wavelength to the one required are either about the same strength or weaker, selectivity need not be very high. If now the sensitivity is raised to enable the weaker stations previously missed to be heard at good strength, the stronger stations on near-by wavelengths will cause interference unless selectivity is raised at the same time. The "straight" four-valve set with two HF stages is dying out for precisely this reason; its selectivity is not high enough for its sensitivity, and it brings in hardly any more *useful* programmes than an equivalent set with one HF stage less.

The sensitivity of a set is usually expressed as "so many microvolts." This is an abbreviated and incomplete description, requiring to be expanded before it becomes intelligible. A set has a sensitivity of 100 microvolts if a carrier voltage of that magnitude, modulated to a depth

of 30 per cent., and applied to the aerial terminal, evokes from the output valve 50 milliwatts of audio-frequency power derived from the modulation. Fifty milliwatts is a very small output; modern mains sets generally give some 2 watts, forty times as much. We have therefore the paradoxical position that a set of sensitivity 100 microvolts ($\mu\text{V.}$) will not satisfactorily receive a station giving that voltage at the aerial terminal; to give a minimum of 800 mW. (sixteen times the conventional 50 mW.) an input of $100 \times \sqrt{16} = 400 \mu\text{V.}$ will be needed. This point needs to be borne in mind in what follows, for we shall deal with mixed units; sets rated on the 50 mW. basis in conjunction with the field-strengths necessary for full-strength reception.

It will not be of much use to discuss figures of sensitivity unless the reader can interpret them in terms of his own experience. Probably the best way of giving some semblance of reality to bare figures will be to quote sensitivity data in connection with receivers of well-known types. All figures will refer to sets designed for mains operation; for battery sets the sensitivity will be much lower.

A set intended purely for local-station reception, and consisting of a detector and output valve only, will have a sensitivity of the order of 100 to 200 *millivolts* ($= 100,000$ to $200,000 \mu\text{V.}$) when reaction is not used. If reaction is introduced, this figure will, of course, fall (sensitivity will rise) to an extent depending chiefly upon the fineness of adjustment, both of reaction and tuning, that the design of the set and the user's skill can achieve.

If an HF stage is added, giving a gain of some fifty to one hundred times, the sensitivity will rise to about 2 millivolts in the absence of reaction. This figure represents very fairly the best of the commercial sets built to this circuit, though there are rather wide variations between sets of different makes.

With two HF stages preceding the detec-

tor the sensitivity becomes comparatively high, approaching, in an efficient set, some 20 microvolts on the wavelengths at which sensitivity is at its best. There are considerable variations over the wave-band.

Superheterodynes of the simpler type, consisting of frequency-changer, IF stage, diode detector, and high-slope output pentode, usually have sensitivities ranging from 50 to $250 \mu\text{V.}$, the former figure representing about the maximum sensitivity of any commercial set of this type. Where an LF amplifying stage is added, either by using a DDT as detector-amplifier or by reflexing the IF stage, the sensitivity may rise to as much as $5 \mu\text{V.}$, though $20 \mu\text{V.}$ is a more usual value. Much the same sensitivity is attained by the older type of set (with manual volume-control in place of AVC) in which a triode or screen-grid valve is used as detector.

The most ambitious type of superheterodyne, where an HF stage precedes the frequency-changer, and an LF stage is included between the (diode) detector and output, may have a sensitivity as great as $1 \mu\text{V.}$ or even better. Receivers intended for use in cars are generally built to a circuit of this type, and have a sensitivity of this order.

Typical Sets Compared

The accompanying series of sensitivity curves sums up briefly the performance of typical sets of the various classes mentioned. No pretence is made that these curves represent the carefully worked out average of a number of sets of each class. They were actually drawn freehand, in the most casual manner possible, across the graph paper—nevertheless, they do sum up the result of quite considerable experience in measuring both finished commercial receivers and sets in course of design. Because of the large admixture of the latter type of measurement, the curves are probably on the optimistic rather than the pessimistic side.

The rather rapid rise in the curves (drop in sensitivity) at the extreme 200-metre end arises from the fact that nearly all sets run a little out of gang below about

Need a Set Be ?

210 to 220 metres. In sets using HF amplification, the rapid rise in stray reaction partly offsets this effect. Superheterodynes, it will be noticed, have a fairly constant sensitivity over the wave-band, while sets depending on HF amplification give curves showing that sensitivity drops fast towards 550 metres. This effect, especially marked in the 2-HF curve, is due to the fall in dynamic resistance of the intervalve-tuned circuits as the longer wavelengths are approached. It can also occur in the first tuned circuit, but in that position it is normally offset by using a mixture of inductive and capacitive coupling between that circuit and the aerial itself. In the case of the superheterodyne, with practically all the amplification taking place after frequency-changing, this one precaution suffices to give a reasonably flat curve.

Perhaps the most interesting point about the diagram is the congestion of curves round about the region from 20 to 100 microvolts. This is due to several causes. First, the sensitivity-curve of the 2-HF set cuts right across this region. Secondly, the simple three-valve superheterodyne, having no great reserves of sensitivity (and no reaction to be called in where necessary), is generally "squeezed" to get the last ounce of range from it. In the four-valve set, incorporating an amplifying stage between diode and output valve, full advantage of the extra stage in increasing sensitivity is seldom taken, for if it were the signal at the diode would be too small to provide adequate AVC control. Sensi-

tivity is therefore sacrificed by using a low-slope pentode, or even a triode, as output valve. Even after this, excessive gain often remains. Advantage is taken of this to introduce a very helpful measure of tone-correction off-setting high-note loss in

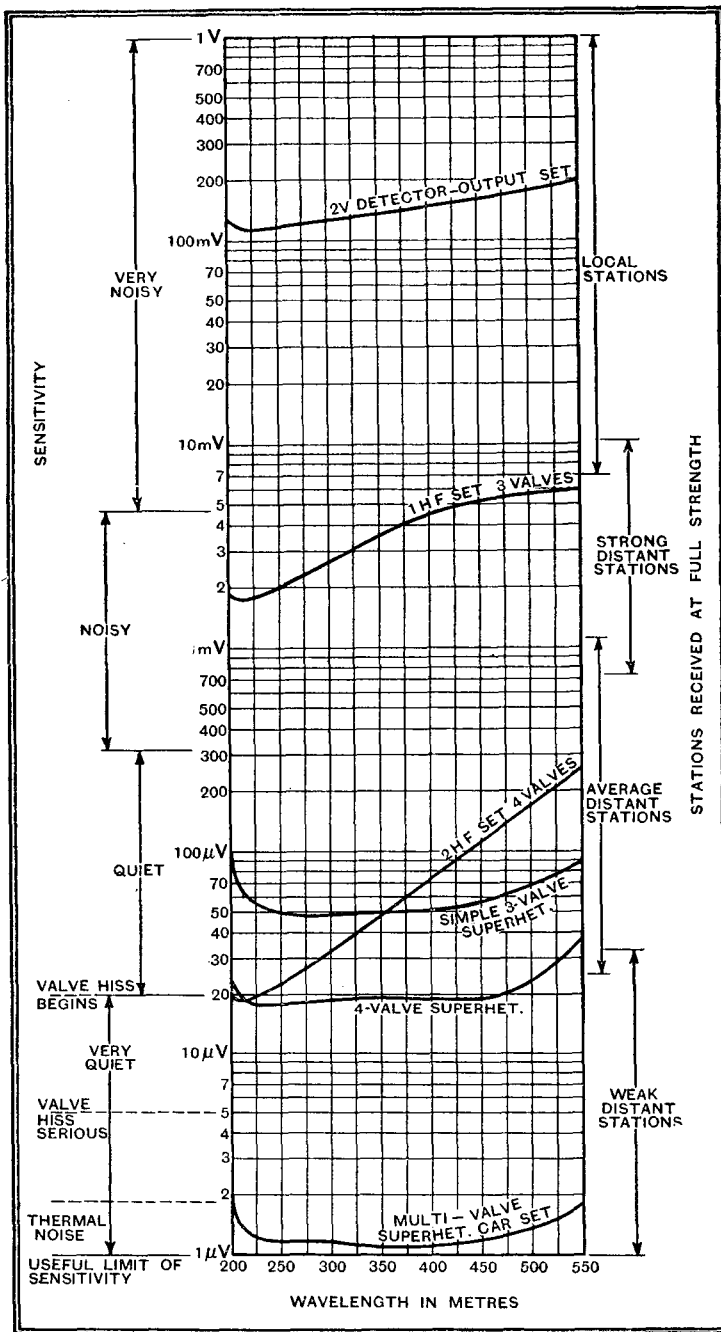

This graph shows the relative as well as the absolute sensitivity of typical sets; also the extent to which noise levels of various intensities will interfere with the reception of signals of different strengths.

the tuned circuits. Generally speaking, a higher sensitivity than about 20 μV., combined with good AVC control, cannot be attained without further pre-detector amplification, either at signal or intermediate frequency, unless resort is had to DC amplification of the AVC voltages.

And now, most important of all, what

kind of performance in the matter of station-getting can be expected from the various types of set?

Obviously, much depends on the aerial, as is shown by the very high sensitivity found necessary for the car set, which has inevitably to work with an absurdly small aerial. Assuming that the aerial is reasonably good, the stations that can be received at full strength by sets of various degrees of sensitivity are very roughly indicated by the lines marked down the right-hand edge of the diagram. The division of stations into "Local," "Strong distant," "Average distant," and "Weak distant," is obviously very rough-and-ready. It is particularly to be noted that the terms used do not refer to the power used by the transmitter but to its field-strength at the receiving aerial. A station whose signals are subject to fading must, therefore, be regarded as drifting back and forth between the "Strong" and "Weak" classifications, no matter whether it uses a hundred kilowatts in its aerial or a humble two.

In Terms of Range

We see, on this basis, that the simple three-valve set is only capable of bringing in a few of the stronger stations, most of which require a set of rather higher sensitivity. Those users of three-valve sets who habitually receive Timbuctoo and other stations notoriously difficult to get are reminded that the curve shows sensitivity *without reaction*. Really skilful handling of the reaction control can easily increase sensitivity a hundred times, rendering this type of set as sensitive as any but the most ambitious type of superheterodyne.

At a sensitivity of round about 500 microvolts a set begins to be capable of bringing in, under favourable conditions, a few of the stronger "average" stations in addition to the "strong" ones. With further rise in sensitivity, the set's "bag" rises rapidly, until at a sensitivity of about 50 microvolts, which roughly represents that of the bulk of sets in the eleven- to fifteen-guinea class, a very large number of stations can be heard well. All that now remain beyond the range of the set are the stations classified as "weak," together with the less well-heard members of the "average" class. Greater sensitivity will bring these in, but the level of background noise will rise very rapidly as the sensitivity of the set is increased further.

Some idea of the extent to which noise interferes with wireless reception can be had from the comparative noise levels mapped out to the left of the figure. A location is here reckoned as qualifying for the description of "Very Noisy" if the full sensitivity of a 5-millivolt set cannot be used without bringing in a noise background loud enough to be troublesome. In such a place the local stations only will be of entertainment value. Such a level of noise as this is very frequently due to some one piece of electrical machinery in the very close neighbourhood of the lis-

How Sensitive Need a Set Be?

tener; in most cases it is possible, therefore, to seek it out and have it silenced. Suppressors in mains leads and other such devices may reduce, but will seldom cure, such bad interference as this.

Less easily diagnosed is the condition which we have described as "Noisy," in which the maximum useful sensitivity is taken as 300 μ V. A noise-level somewhere within the limits shown is common in the less favourably situated districts of towns. Interference at about this level is often found to be due to the concerted efforts of quite a number of sources, none of which are very close to the receiver. Suppression in the listener's own house (mains filtering: screened aerial down-lead) is the best mode of attack in the average case. But it will be noticed that a fair sprinkling of the stronger distant stations will now give acceptable programmes.

Under Better Conditions

A district may reasonably be described as "Quiet" if interference is not serious on the bulk of the stations received on a 2-HF set, a small superheterodyne, or a straight three-valve set with reaction. Favoured districts in towns, or the less quiet suburban or country districts, come roughly under this head.

If it is considered worth while, such little noise as there is can usually be sufficiently reduced to become quite harmless by the application of mains filtering of the more rudimentary sort.

If the full sensitivity of a 20-microvolt set can be used without noticeable interference from man-made noises, the term "Very Quiet" may fairly be applied. In so favoured a place the limit of useful sensitivity in a receiver is set more by inherent noise (valve-hiss and thermal noise) generated within the set itself than by external conditions. In an average superheterodyne a sensitivity of better than

about 20 μ V. means that valve-hiss begins to be heard when the set is used to receive the faintest station within its range, and this hiss becomes extremely objectionable if a 5-microvolt set is used "all out." Since some at least of this hiss can be removed by drastic "tone-control," and since, further, quite a strong hiss can be tolerated momentarily at the "trough" of a bad fade, a few of the more ambitious receivers offer sensitivities of the order of 1 μ V. These, however, almost invariably include a signal-frequency amplifying stage, in which case valve-hiss

does not become objectionable except with rather higher sensitivities than those given for the simpler sets in which this preliminary stage is omitted.

For sensitivities of less than about 1 microvolt "thermal noise," arising from the thermal agitation of the molecules in the grid-circuit of the first valve, begins to be serious. As there is no conceivable cure for this other than keeping that circuit immersed in liquid air or otherwise drastically cooled, 1 microvolt may be regarded as the absolute limit of usable sensitivity.

Transmitter in a Bomb-proof Shelter

A Visit to Radio Poznan

POLISH broadcasting celebrated its tenth anniversary this year. The majority of the shares in the Broadcasting Company, which were formerly in private hands, have now passed over to the State. Apart from programme activities in Warsaw, each of the Polish provincial stations provides a certain number of independent programmes, and, for about three or four hours a week, all Polish stations, including Warsaw, relay from one of the provincial centres. In Poland it would be wrong to consider such towns as Cracow or Lwow or Poznan as entirely devoid of artistic life. Polish history has not permitted of centralisation such as we find in France or, for that matter, in England.

A recent visit to the most western city of the country, Poznan, situated in what the Poles call the "cradle" of Poland—it was for over a century under German rule—brought these facts home to me. Poznan has its own opera house, which is now considered to have the best ensemble in the country. Poznan has its own way of doing things, which greatly varies from other parts of Poland. For instance, when broadcasting started the city was impatient about opening a transmitter, and formed a company of its own, which was independent until 1932, when it was absorbed by the all-Polish broadcasters.

Poznan's studios are situated in a former theatre close to the centre of the town. In decoration they still date from 1927, but not in technical equipment. The chief engineer

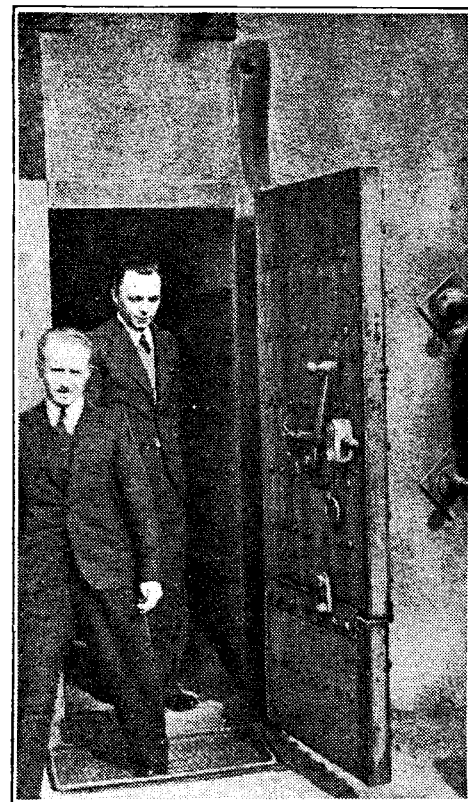

The Chief Engineer (in rear) standing in the doorway of the bomb-proof shelter, erected during the War, which houses Radio Poznan's 16-kW. transmitter. The walls are 7ft. thick.

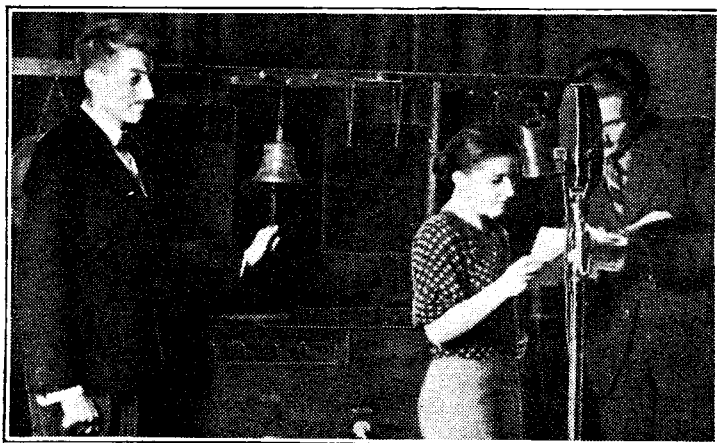

Somewhat primitive "effects" are used at Radio Poznan; there is no suggestion here of multi-studio radio drama. Sports and election results sometimes keep the Radio Poznan announcers busy until the small hours of the morning. In this picture the relief announcer can be seen resting.

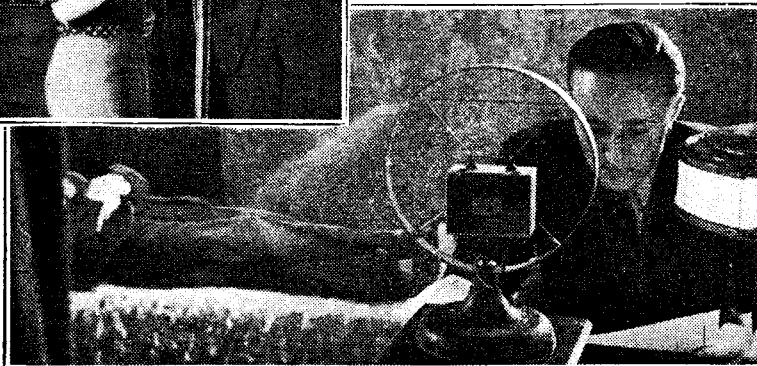

proudly told me that he and his staff do everything themselves. They construct their own microphone amplifiers and their own signalling systems, and are at present building a suitable long-wave receiver for relay of Warsaw programmes during the daytime, as the land-line link is not of the high quality necessary to do justice to the fine orchestral concerts from the capital.

The accompanying photos show some of the features of Radio Poznan. In taking these I have tried to show the "different" way that things are done there.

"WANDERING WAVE."

Range of Five-metre Transmissions

Conditions Under Which the Theoretical Limit is Exceeded

By D. R. PARSONS, Grad.I.E.E. (Stratton and Company, Ltd.)

IT is now well established that the optical limitation of range, as originally predicted for ultra-short-wave transmissions, has on occasions been greatly exceeded. The author of this article discusses the conditions under which ultra-optical ranges may be obtained.

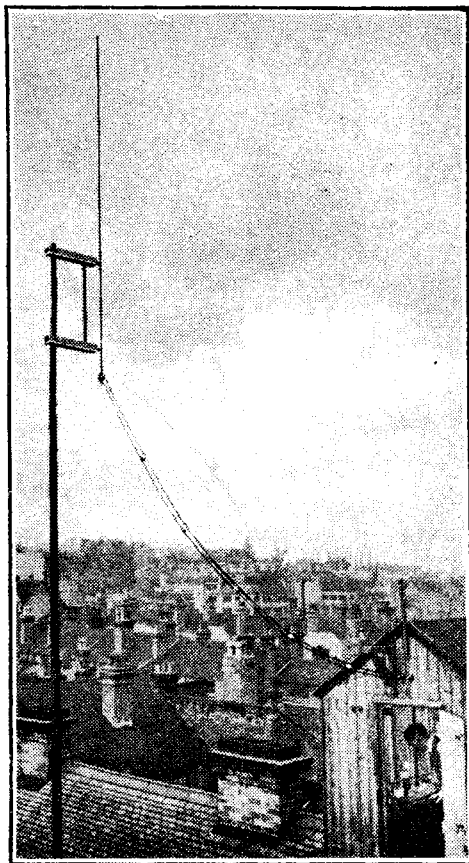

The Eddystone experimental transmitter, though situated in surroundings that are by no means ideal, has been heard at "ultra-optical" distances.

At the present time of year, when 5-metre activity reaches its height, it is of interest to cast our minds back and see what we have learned about the receiving and transmitting possibilities of these ultra-short wavelengths.

In the early days of 5-metre working we were informed by the few experts available that radio waves propagated with a frequency of 60,000,000 cycles/sec. would obey quasi-optical laws, resulting in communication between points which were only visible from each other. The only way, therefore, of increasing the receiving range would be by raising the transmitter or receiver well above the surface of the earth. It was supposed that no reflection or refraction occurred from the Heaviside or Appleton layers, the direct ray being the only wave suitable for reception purposes. How far these early assumptions were correct will now be discussed at some length.

If we have a listener operating a receiver at ground level, then the maximum theoretical distance (still on the assumption of a purely visual range) over which he can receive signals from a given transmitter may be calculated from an extremely simple formula. Alternatively, it

may be ascertained from Fig. 1, which shows the relation between the height of the transmitter above sea level and the distance over which signals can be heard on the horizon. It should be emphasised that this curve is definitely theoretical and is based on an elementary principle which most of us learned many years ago. It assumes that the intervening ground between the transmitter and the receiver is flat and that the power of the transmitter in question is sufficient to energise the sensitive detector of the receiver at the distance given on the ordinate. It is interesting to note, however, that the slope of this curve falls off rapidly as the height of the transmitter increases, particularly above 2,000 feet.

Since the early days of 5-metre working it has been known that a slight bending of the waves occurs, resulting in slightly larger distances being covered. The same thing appears to occur with light rays, for local inhabitants claim that the Eddystone lighthouse can be seen from the summit of Cader Idris (2,927ft.) on a clear day, a distance of 170 miles. Since the writer has never been up Cader Idris on a clear day he cannot substantiate this claim! Fig. 2 shows the effect of this bending property.

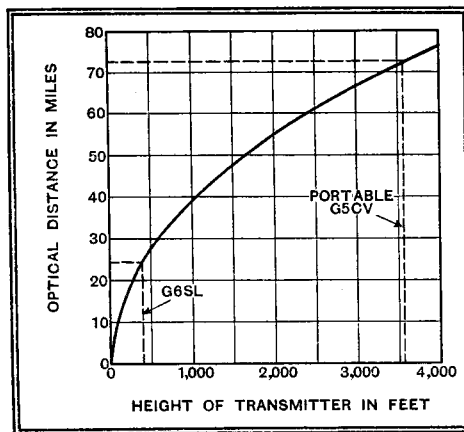

Fig. 1.—Theoretical maximum range, on an optical basis, for various heights of the transmitter.

Extremely long distances have recently been covered. The Berlin television transmissions from the Brocken Mountains have been received daily by the English Post Office Engineers, and the German authorities have recently been receiving enthusiastic reports from amateurs in Buenos Aires and New York. In the last two cases the reliability of the reception has not been maintained.

In the United States of America, consistent two-way communication between

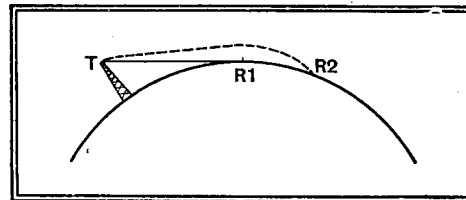

Fig. 2.—Illustrating range (R1) of a transmitter T on the assumption of a straight optical path. R2 shows the increase of range of waves following a "bent" path.

the Blue Hill Observatory of Harvard University and West Hartford has been regularly obtained at a distance of ninety-three miles. Scheduled reception on 234 days out of 239 days has occurred, and the conditions were such as to make it a commercial proposition. Farther, Chicago and New York City have been linked by 5-metres, the distance in this case being no less than 720 miles!

Turning to our own country, we had Mr. Douglas Walters (G5CV) radiating a small signal from the top of Snowdon and being picked up 207 miles away. Further, the Eddystone transmitter (G6SL), situated at Birmingham, 400 feet above sea level, has been received South of London, a distance of 110 miles. The latter is not a freak result, since the transmitter is situated in the heart of a big city, as the accompanying photograph shows. The theoretical reception distances of the last two stations have been indicated on the curve of Fig. 1.

Two questions arise out of the above

Range of Five-metre Transmissions—

reports. First, what atmospheric conditions cause such results, and, secondly, what can we learn from these pioneering experiments?

Readers are well acquainted with the indirect ray method of reception used on

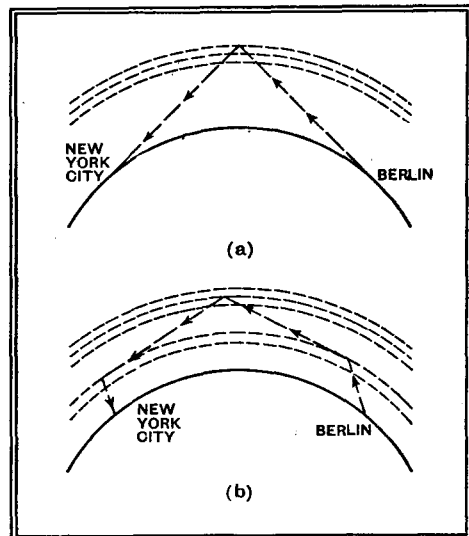

Fig. 3.—Illustrating the effect of reflection from a single ionised layer, and of a combination of refraction and reflection by two separate layers.

ordinary short wavelengths. On the broadcast band the direct ray becomes attenuated after fifty to eighty miles—on short waves it disappears after about twenty miles, but signals reappear in the form of an indirect wave, perhaps 5,000 miles away. It is not too fantastic to presume that on the ultra-short wavelengths, where the direct ray is purely optical, that the indirect ray appears at such a distance that it only comes back to this earth during rare atmospheric conditions.

It seems to the writer that these long-distance records should be divided into two categories, namely:—

(a) Reception from 20 to 100 miles.

(b) Reception at great distances, i.e., above 1,000 miles.

Taking case (a), we have some valuable information available from the American experiments, covering reception up to 100 miles.¹ These experiments have shown that stratification of the lower atmosphere bends the ultra-short waves over a much larger path of reception. Photographic recordings taken over a long interval of time have shown that there is a close relation between the periods of large temperature inversion in the lower atmosphere and the periods of very strongly received signals. The term "temperature inversion" should be defined.

Normally, as is generally known, the temperature of the air decreases, or has a lapse rate of 1 deg. C. for every 300 feet rise in elevation. Sometimes, however, the temperature does not fall as rapidly as this, in fact it may rise, and a temperature inversion is said to take place.

¹ For a detailed report see "QST" for June, 1935.

To put it simply, a layer of warm air on top of a layer of cool air causes good reception conditions. It was found that if a subnormal lapse rate occurred between 900 and 7,500 feet high, then a large signal was obtained over the path of reception. When the air mass conditions were not so heterogeneous and a normal temperature lapse rate occurred, signals dropped back to very low levels. Comparison of hourly readings taken shows that signal strength is lowest at mid-day and high during the period 10 p.m. to 7 a.m. So clearly do the signal strength and lapse rate measurements coincide that it is even suggested that 5-metre receivers and transmitters may be used in the future by the meteorologist. In the case of extremely long distances being covered (b), the information available is very vague. Some authorities have suggested that the sky wave pierces the upper ionised layers and is finally reflected back from some heavenly body!

However, it is highly probable that a highly ionised layer does exist well above the Heaviside and Appleton layers, as shown in Fig. 3 (a), and signals are not often heard, either because of the limited number of listening posts or else the layer is insufficiently ionised for reflection. Alternatively, two layers a few hundred

miles above the earth's surface could cause distant signals by a combination of refraction and reflection, as indicated in Fig. 3 (b).

Which of these theories is correct time and experiment alone will tell, and up to the time of writing we can draw the following conclusions for an elevated transmitter of relatively high power (25-50 watts):—

(a) 5-metre signals give good reliable signals for police working, etc., up to five or six miles in densely populated areas.

(b) Thirty miles is the normal reliable distance over which reception can be obtained under usual circumstances, i.e., over flat, open country.

(c) Signals up to 100 miles can be received only if the lapse rate of the lower atmosphere is subnormal.

(d) Greater distances are obtained during rare atmospheric conditions.

The 5-metre band was given to amateurs in the belief that consistent communication was impossible on these wavelengths. Yet again the amateurs of the world have proved by their ingenuity, resource and perseverance that reliable results can be obtained on what were believed to be useless frequency bands.

In Next Week's Issue**Resistance and Capacity Bridge****Inexpensive Component Tester**

MOST people find the need for a simple method of checking the capacity of condensers. It is best done with the aid of a bridge and it is readily possible to construct a suitable type from quite a small number of components.

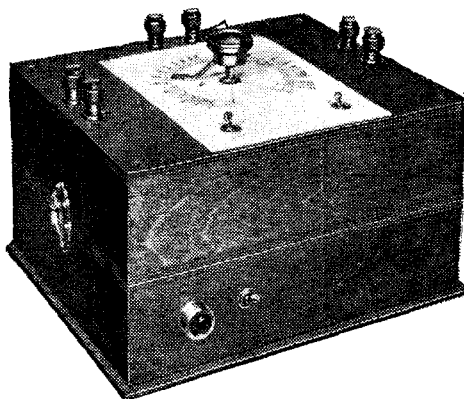

The capacity bridge, moreover, can by means of simple modifications be used also for the measurement of resistance over a wide range. The bridge to be described in next week's issue is of this type, and permits condensers of 10 mmfds. to 10 mfd. to be measured in two ranges, while resistances between 10 ohms and 10 megohms can also be checked.

The bridge requires a source of alter-

nating current for energising it, and while this can be provided by a buzzer, a valve oscillator is advisable where reliability is required, and details of a suitable battery oscillator of very economical design will also be given.

LIST OF PARTS**BRIDGE**

- 1 Wire wound potentiometer, 20,000 ohms non-taper
Reliance "TW"
 - 1 Resistance, 50,000 ohms, 1 watt
Amplion
 - 1 Resistance, 1,000 ohms, accuracy ± 1 per cent., 1 watt
Amplion
 - 1 Resistance, 100,000 ohms, accuracy ± 1 per cent., 1 watt
Amplion
 - 1 Fixed condenser, mica 0.1 mfd., accuracy ± 1 per cent.
Muirhead M71
 - 1 Fixed condenser, mica 0.001 mfd., accuracy ± 1 per cent.
Muirhead M71
 - 2 Switches, DPDT
Bulgin S98
 - 1 Knob
Bulgin K12
 - 6 Ebonite shrouded terminals, "phones" (2), "input" (2), "X1," "X2"
Belling-Lee "B"
- Wood, wire, screws, etc.

OSCILLATOR

- 1 Valve holder, 4-pin
WB Baseboard type
 - 1 Tapped choke, 3 henries
Varley DP18
 - 1 Resistance, 100,000 ohms, $\frac{1}{2}$ watt
Bulgin HW25
 - 1 Resistance, 10 ohms
Bulgin AR10
 - 2 Fixed condensers, 0.01 mfd.
Dubilier 670
 - 1 Switch, on/off
Bulgin S80T
 - 1 Flush signal lamp with 12mm. 60 m-A. bulb
Bulgin D9
 - 1 3-volt battery
Ever Ready, Large
Twin 2-cell 800
 - 2 Grid bias batteries, 9 volts
 - 4 Wander plugs
Elex
 - 2 Ebonite shrouded terminals, "output"
Belling-Lee "B"
 - 1 Valve, L21
Osram or Marconi
- Wood, wire, screws, etc.

CURRENT TOPICS

Up-to-date Algiers

NEW yellow and red posters in the streets of Algiers appeal to radio manufacturers and listeners to do all they can to avoid radio interference.

"Ethereal Enquirer No. 1"

THIS is the description applied to M. Raymond Brillaud, Technical Chief of the International Broadcasting Union, by a French journal. It is pointed out that he has already enquired into 800,000 cases of wavelength wobbling. In 1,000 cases special warnings were issued.

Honour Declined

MR. I. W. SCHLESINGER, head of the African Broadcasting Co., has notified the Union Government that he cannot accept the Chairmanship of the proposed African Broadcasting Corporation.

The Corporation is being modelled on lines suggested by Sir John Reith.

Marconi Broadcasting To-morrow

TO - MORROW (Saturday) Marchese Marconi is expected to broadcast from the Rome short-wave station. His message will be intended for reproduction on loud speakers at the unveiling of a memorial at Wahroonga, near Sydney, marking the place where the first wireless message from Britain was picked up in Australia. This was sent on September 23rd, 1918, by the Australian Prime Minister, Mr. William Hughes, returning from a visit to the Western Front.

Mr. Baird on a Television Pioneer

MR. JOHN L. BAIRD, of television fame, gave the first Kerr Memorial lecture on Thursday, December 5th, at the Royal Institution under the auspices of the Television Society of London. The Society's President, Sir Ambrose Fleming, occupied the chair.

In his lecture, which covered the life and work of Dr. John Kerr, Mr. Baird said that in the account of his first investigations on the subject, in 1875, Dr. Kerr made use of these actual words: "I cannot conclude without expressing the hope, amounting almost to a belief, that the plate cell will develop from its present rude beginning into a valuable electrical instrument."

The lecturer showed that this prophecy had been amply fulfilled, and stated that the ma-

jority of the developments in television owed a great deal to Dr. Kerr's researches.

Why the Hum?

POST OFFICE engineers have been seeking, without success, the origin of a 120-cycle hum on the Australian and South African beam telephone services.

An evening journal suggested last week that the hum was caused through the draining of the world's oil supplies, causing wearing of the bearings of the earth's axis!

on the mornings of December 19th to 22nd. All communications and reports should be addressed to Mr. H. J. Powditch (G5VL), Porth, St. Columb Minor, Cornwall, who is arranging the tests on behalf of the R.S.G.B.

Christmas Radio Greetings

CHRISTMAS greetings can be sent by wireless at cheaper rates between December 14th and January 6th, according to an announcement by Cable and Wireless, Ltd. The new rates are 2s. 6d. for ten words, and

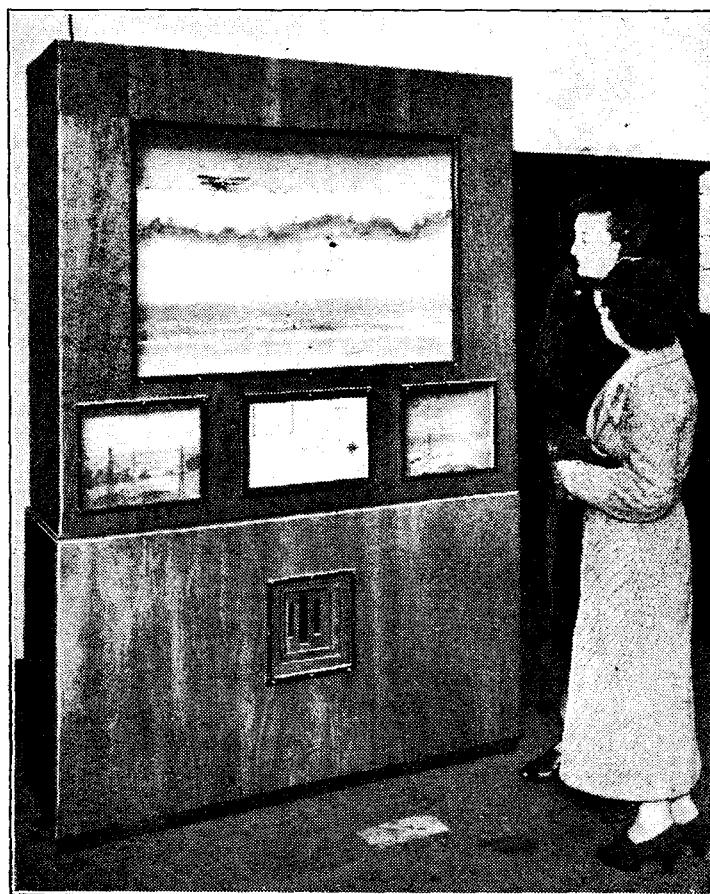

D.F. DEMONSTRATED—The Marconi diorama at the Imperial Airways Exhibition at the Science Museum, South Kensington. A gramophone record reproduced through the loud speaker gives the conversations between a plane pilot and the Control Tower, Croydon, in obtaining bearings during fog with the help of observers at Lympne and Pulham. The Exhibition is open free daily until January 31st.

Transatlantic Tests

NEXT week the Radio Society of Great Britain is conducting a series of transatlantic tests on the 80-metre amateur band in co-operation with the American Radio Relay League.

It is hoped that British amateurs will abstain from transmission on these wavelengths during the silent periods between 11.45 and midnight (G.M.T.) on the nights from December 14th to December 18th, and between 5 to 5.15 a.m.

even less in certain cases. In addition a standard greeting service is available for messages to the United States, Canada, and other countries.

"Photograms of the Year"

THAT it is in its forty-first year of publication is sufficient testimony to the popularity of "Photograms of the Year" among a vast number of photographers all over the world. The 1936 edition, just issued, emphasises the inter-

Events of the Week in Brief Review

national character of the photographic art, for among the sixty-four beautifully reproduced plates are contributions from Australia, America, Germany, France, Czechoslovakia, China, and many other countries, as well as a number of concise reports from all over the globe dealing with the progress of pictorial photography. A special feature of the book is a series of critical comments on the illustrations.

"Photograms of the Year, 1936," is published by Iliffe and Sons Limited, Dorset House, Stamford Street, London, S.E.1, price 5s. paper covers, 7s. 6d. cloth. It is obtainable direct from them, postage 6d. extra, or from all booksellers, bookstalls and photographic dealers.

"W.W." at Christmas

THE next issue of *The Wireless World*, dated December 20th, will be on sale on Thursday next, December 19th.

Franco-American Broadcasts

REGULAR interchange of broadcast news between America and France has been arranged by the French P.M.G., M. Mandel, in agreement with the Columbia Broadcasting System. The service began on November 27th, when the American transmission was received and relayed by Paris P.T.T. France reciprocated with a broadcast from the Colonial station on December 4th, which was relayed by the entire Columbia network.

The news from America is given first in English and then in French; the French news is transmitted in English.

Opportunities in R.A.F.

THE Air Ministry announces that 300 vacancies will occur in February next for Boy Entrants (between 15½ and 17½ on February 1st, 1936), for training as wireless operators, armourers and photographers in the Royal Air Force. Particulars can be obtained from the Air Ministry (Boy Entrants Dept.), London, W.C.2.

Small Ads. at Christmas

WITH the approach of the Christmas holidays slight alterations are necessary in our printing arrangements. Miscellaneous advertisements intended for the issue of December 27th must be received not later than first post on Thursday, December 19th.

By
LESLIE BAILY

Scottish Regional gives a good signal in the centre of Scotland, but is poorly heard in Inverness.

Does Broadcasting

A REGIONAL TOUR OF INVESTIGATION

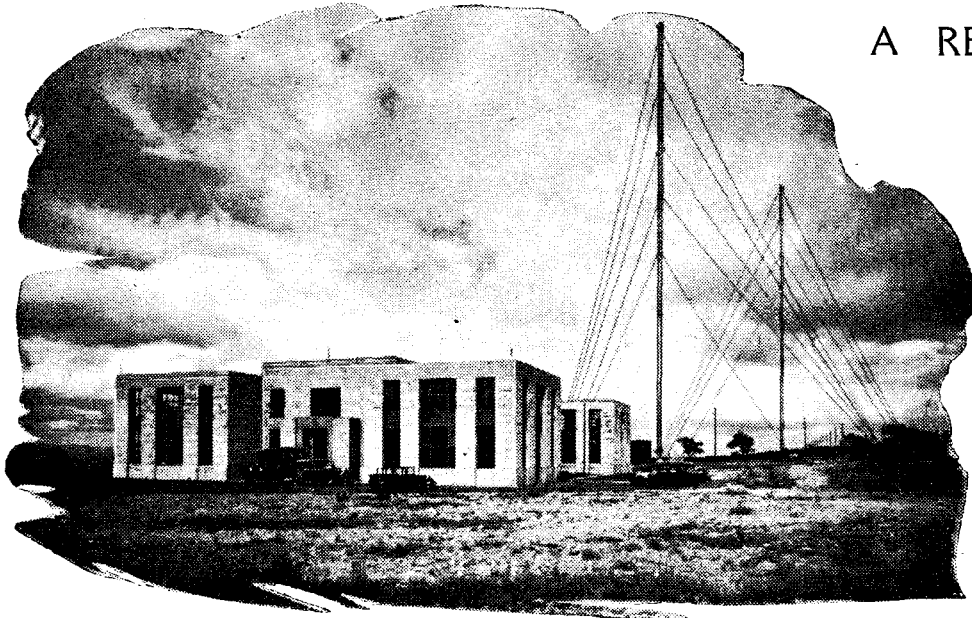

With Carruthers as Station Director, Glasgow became the B.B.C. focus in Scotland. In 1925 they took the present premises in Blytheswood Square, in fact the present accommodation and a bit more also, for those years were Glasgow's broadcasting heyday . . . up to 1930. Then, rather foolishly (as one can see, being wise after the event), there was a wholesale centralisation on Edinburgh; part of the building was vacated, the staff dwindled, and finally Glasgow lost its own transmitter when Scottish Regional opened in 1932 (the Regional, of course, gives a much better service than the old 5SC ever did).

Overcrowding

Now the pendulum swings back. Several programme chiefs have returned to Glasgow—Mr. Keith-Murray, for instance, who runs Scottish O.B.s, has his office there; and so has Dr. Low, Education Officer, and during my tour of these patently over-crowded studios and offices I came across the Educational Advisory Committee holding pow-wow. The Glasgow staff has lately leapt to thirty, and so inadequate has the place become (there is not even a studio large enough for the local Scottish Orchestra) that the B.B.C. has wisely decided to make a fresh start. Queen Margaret College, an old university

VI.—From Glasgow to Burghead

AFTER seeing the fine Northern Ireland Regional station at Lisburn, where the engineers are trying-out every conceivable new idea in transmission technique, I crossed by Larne to Stranraer, in Scotland, to investigate what is being done there to improve the B.B.C.'s service to its listeners.

I motored north along the magnificent coast road from Stranraer, through Ayr. In this south-western corner of Scotland I found not a few keen followers of the Belfast programmes, despite that station's shortage of kilowatts. Lisburn, though intended primarily to serve Ulster, ought, with its 100 kilowatts, to give listeners here, and also in Cumberland, a first-class signal. Cumberland is a neglected area; such a town as Carlisle, though in the North Region, is too far away from that transmitter to enjoy fade-free reception. But the new North-east Regional station, to be erected near Hexham, will improve

conditions in addition to the amenity of good reception from Lisburn.

My visit to Glasgow came at yet another time of vicissitude in the history of broadcasting here. I had the good fortune to meet Mr. Cameron, formerly Superintendent Engineer for the North, and now Scottish Regional Executive (the only instance I know of an engineer going over to the administrative side), and he told me how he ran the amateur transmitter 5MG in Glasgow, at which such personalities as Herbert Carruthers and Kathleen Garscadden broadcast before the B.B.C. set up here in 1923.

Robin Russell (left) and Kathleen Garscadden in the Scottish Children's Hour. Below is the Educational Committee in full session.

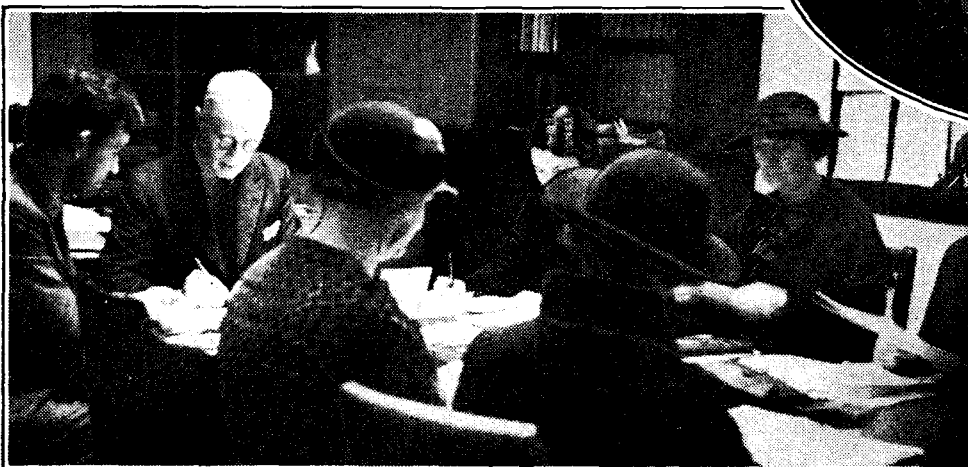
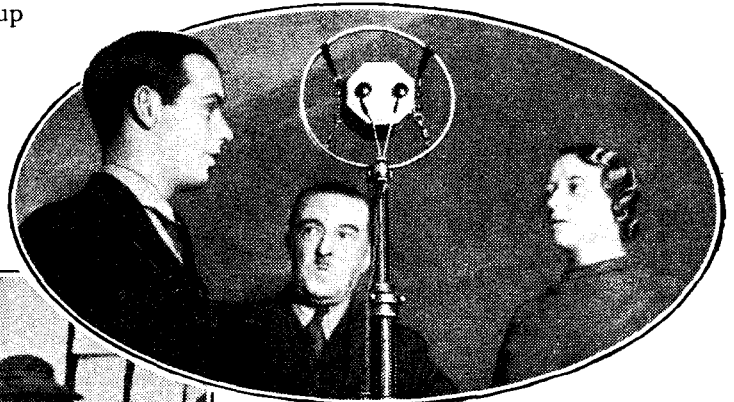

hostel, is to be converted into a thoroughly up-to-date Broadcasting House, and in perhaps a year's time the B.B.C. will leave Blytheswood Square.

Glasgow is one of the points of that far-flung triangle of studios which feed programmes to the Scottish Regional transmitter at Falkirk; the others—Edinburgh and Aberdeen—I shall visit later on this journey. In one department of programmes, Glasgow actually does the lion's

Serve Britain ?

share—variety—and in the largest of the three studios I found Mr. Robin Russell conducting a variety rehearsal—immediately followed, in the same studio, by the Children's Hour, in which the same Mr. Russell became an "Uncle." Certainly, the staff get plenty of variety at these provincial stations!

A Woman Announcer

With Uncle Robin was Auntie Kathleen—none other than 5MG's Miss Garscadden, still going strong. For twelve years she has broadcast almost daily in the Children's Hour, and as a vocalist, and lately as temporary Scottish Regional announcer, a job which has turned the Press limelights full upon her.

Another old-hand is one who came, a wee laddie with bare knees, in 1923, to do odd jobs in the control room—now he's a fully fledged engineer and a married man. That sort of thing makes one realise with a shock how old the B.B.C. is getting!

Engineer-in-Charge Hill, who has been here since 1924 and was responsible for engineering that fine broadcast of the Queen Mary's launching, showed me the new control-room equipment, installed a year ago—all of which will have to be ripped out for the forthcoming house-moving.

"So"—I mused to myself, leaving Glasgow and turning my bonnet northwards—"here, as in so many other places I've visited during this journey, a big and expensive effort is being made to make broadcasting serve Britain better by improving local programme facilities. Now let's look whether the transmitters are able to cover the country adequately—or rather, let's listen." And I switched on my McMichael portable, tuned to Scottish Regional.

At Stirling and at Perth this station was coming in well, but as I climbed over the Grampians night began to fall, and a blight fell upon Scottish Regional; by the time I reached Inverness it was on my black list. So I switched over to Droitwich, hoping at least to get the National. I had an ugly surprise.

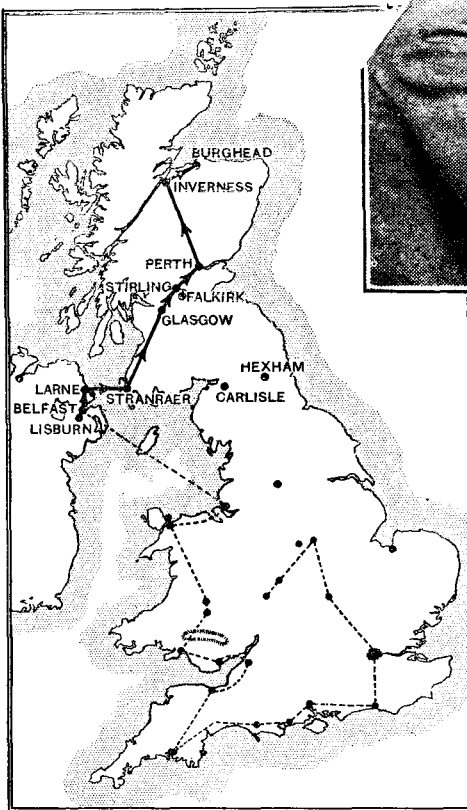

Fading was such as to rob listening of pleasure. I admit that, as one who lives in the well-served London district, my standards of fadeless, high-quality reception are stringent, but an Inverness radio dealer confirmed my impression. He sum-



Paul Ellingham at the Glasgow dramatic control panel.

marised reception conditions in expressive (but un-Scottish) manner with a single word: "Lousy."

The trouble is not only fading and distortion, but interference on long waves. The engineers deserve our sympathy! Scotland, with its mountains, its unwieldy shape, and a geology that causes excessive radio attenuation, is a sticky problem. The shortage of wavelengths has added to the difficulty of serving this country in the past. But there is no doubt that the agitation led by ex-Provost Murray, of Dingwall, caused the B.B.C. to face up more seriously to the poorness of its service to North Scotland, where reception is worse than in any other area I have visited. The onslaught Mr. Murray conducted is famous, the victory he achieved is now being perpetuated in stone by the erection at Burghead of the North Scottish Regional station.

Why Not a Twin-Transmitter

But the victory is only half a victory. The Regional programme comes to North Scotland, but not the National. There would be more justification, in my view, for a twin-transmitter (National and Regional) at Burghead than there is in such a place as Brookmans Park or Moorside Edge, where the "Little National" pumps out a signal to an area admirably served by Droitwich.

It may be said that this North Scottish district is sparsely populated, and indeed the increase of licences after Burghead opens is unlikely to repay the cost of the

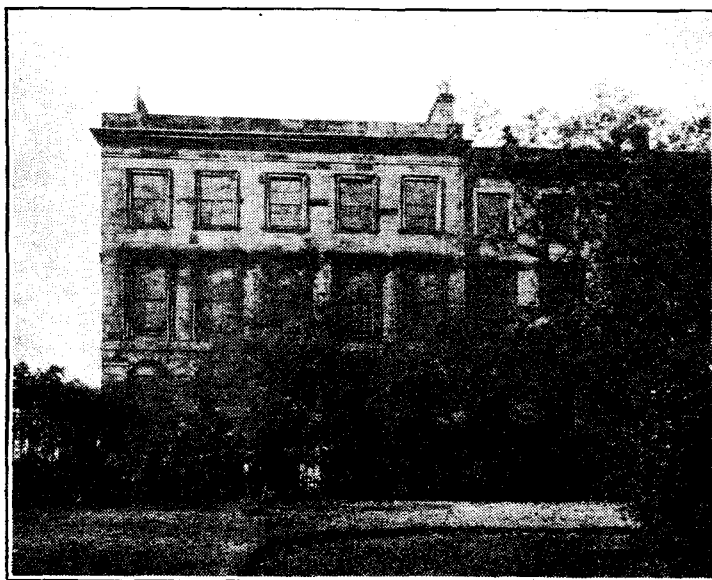

The present Glasgow headquarters. Next year a move will be made to Queen Margaret College. On the right is the triumphal cartoon which appeared in the "Aberdeen Evening Express" when Provost Murray's campaign induced the B.B.C. to erect the new Burghead transmitter.



Does Broadcasting Serve Britain?—

station; but it is in such districts, far removed from centres of entertainment and social activity, that the individual's need for a good and reliable broadcasting service is greatest. As I came over the Grampians to Inverness I noticed that almost every lonely farmhouse had its aerial, slung to a high mast. To each of these, broadcasting must mean more than to a dozen city-dwellers.

In any case this city of Inverness is not the fishing village that so many South-erners seem to imagine!

From here I motored thirty miles to Burghead. What I saw there will be related in my next article. This transmitter, now building, will be British broadcasting's most distant outpost. It will be connected to the B.B.C. system by land-line to Aberdeen. Whether there will also be a line to Inverness, with a studio there, is undecided, but it seems likely. I heard of one Inverness choir that was £10 out of pocket after travelling to the Aberdeen studio for a broadcasting engagement.

Next Tour: *Burghead and Aberdeen.*

the President of the Court, Sir Boyd Merri-man, congratulated the captain of the *Newfoundland* on the praiseworthy, plucky, and prompt manner in which he had acted.

Television for Air Pilots

IT is announced that the National Physical Laboratory, subsidised in this instance by the Air Ministry, is engaged in research into the possibility of using some kind of television transmissions for guiding the pilots of aircraft to their landing grounds in foggy weather or when snow is falling. The scheme at present under consideration is that, once the position of the aircraft has been fixed by means of the direction-finders, a map of the landing ground and the surrounding country shall be projected on to the viewing screen situated in front of the pilot. His own position can then be indicated to him at any instant by means of a moving spot of light. As he would know the height at which he was flying by means of his altimeter, it should thus be possible for him to land safely in the thickest weather.

Problems to be Solved

At first glance the proposal seems an excellent one, and I have no doubt that it has big possibilities. At the same time there may be problems involved which will not be solved in a moment. One of the most important will no doubt be to determine just what degree of definition is necessary to enable the pilot to read sufficiently well the map projected on to the viewing screen. If fairly low definition is good enough, so that no great frequency-range is involved, transmission may be made with small power on the wavelengths already used by aircraft. But it is possible that something a good deal clearer than 30-line transmissions will be needed, in which case it will probably be necessary to use ultra-short wavelengths. Should this be so, the problem of avoiding interference will have to be tackled.

The Service Problem

THOUGH broadcasting is now in its fourteenth year it seems to me that the business of repairing and servicing wireless sets generally still leaves a good deal to be desired. The parallel between the development of the motor car and that of the wireless set has often been drawn—and there was a good deal in it. What is the position as regards repairs and service in the two industries? Supposing that your car breaks down, you can take it to the nearest garage on the official lists of one or other of the big motoring associations, feeling pretty sure that you will find there mechanics who know their job and will deal efficiently with the trouble. Several makes of car, again, have their own approved service stations all over the country with fixed-price schedules for repairs and replacements. In any event, the garage will be able in probably 999.9 cases out of 1,000 to tackle the job itself, and there will be no question of sending the car back to the makers.

But you don't yet find the same desirable state of affairs generally prevailing in the case of wireless receivers. Far too often the local man has to confess himself beaten and to suggest that your only course is to return the set to the factory which gave it birth. In other words, garage mechanics taken as a whole are more efficient in their line than are wireless men, again taken as a whole, in theirs. There are many first-rate wireless service men, but the other sort are still far too numerous.

Random Radiations

Ionosphere Fauna?

WASN'T it H. G. Wells who wrote a good many years ago—certainly long before balloon ascents into the stratosphere were thought of—a story about aerial explorers who flew a plane to terrific heights and found to their astonishment that the upper regions of the atmosphere were inhabited by uncanny monsters? On turning over the pages of one of the lay papers the other day I thought for a moment that this prophecy, like not a few others of H. G. W.'s, was turning out to be true. I read to my amazement that the experts at the Radio Research Board were very busily engaged in measuring the height of lairs in the ionosphere. So that there shouldn't be any mistake about it, we were told a sentence or two later, "Some of the signal, however, goes up to a 'lair' and then down again and arrives later to the receiver." My best thanks to the gifted writer for revealing thus the lighter side of Heaviseide. Perchance he had visited Whipsnade as well as Slough, and had somehow got his notes a bit mixed.

The Loud Speaker Again

AS an earnest student of problems such as "The Effects of Wireless upon Human Society," I was thrilled to read that the first genuine wireless divorce had just taken place in the United States of America, which is, of course, a very right and proper setting for such an historical event. Wireless is really getting on! We had the first wireless murder some months ago when a French flat-dweller quite understandably shot the *concierge* because the latter made too much noise with his loud speaker and refused to desist when called upon to do so. The loud speaker was also responsible for the radio divorce. The petitioner was a village blacksmith in far-away Massachusetts. He explained to the Court that, though on the best authority, a blacksmith's work earned a night's repose, he was completely unable to get his. Mrs. Blacksmith *would* have the wireless set going all out as long as there was anything to tune in—and since North America is a large continent with a three-hour time difference between East and West, you can go on tuning things in for about twenty-three hours out of the twenty-four: the big stations mostly close down at two o'clock in the morning by local time and start business again at half-past six. Understandingly, the Court listened to the blacksmith's tale. Without a moment's hesitation a divorce was granted.

By "DIALLIST"

A Wonderful Rescue

ONE of the most extraordinary shipping rescues in the history of wireless was brought to light recently when a £2,000 award was made to the Liverpool steamer *Newfoundland* for her wonderful work in extricating another steamer, the *Tower Bridge*, from pack ice in the North Atlantic last April. The two ships never came within sight of one another during the whole incident. The *Tower Bridge*, when holed and leaking badly, sent out an SOS message, which was picked up by the *Newfoundland*. The former ship was then surrounded by pack ice, and believed that her only way out was to steer southwards. The *Newfoundland*, however, was able to tell her captain that he would have to go sixty miles in that direction before reaching open water, but that if he set an easterly course twelve miles would see him clear. These instructions were acted upon, and the *Tower Bridge* safely reached St. Johns, the port for which she was bound. Wireless has many ship rescues to its credit, but this extraordinary feat has no equal. It was good to read that

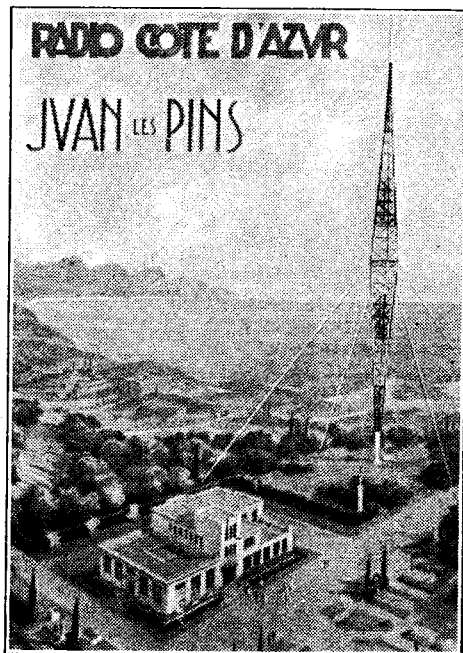

IDEALISED RADIO. The perfect Broadcasting station, as portayed on a French poster announcing the forthcoming opening of a 15 kW. Juan-les-Pins transmitter. The existing 0.8 kW. plant will be dismantled.

UNBIASED

More Delay

TELEVISION is still very much in the air, or rather it isn't in the air, and nobody seems to know exactly when transmissions are going to commence. Forecasts range all the way from next February to the end of the century, while one rumour has actually reached me to the effect that it has already started, but is being deliberately kept dark, as the set manufacturers haven't yet got any receiving gear to sell.

By
FREE GRID

I am afraid, however, that the idea of using the film-recorded-thirty-seconds-delay method is causing a certain amount of public misgiving. If this is done the scenes on our receiving screens will lag thirty seconds behind the scenes being enacted in the studio. It appears that certain evilly-disposed persons are suggesting that if there is to be a thirty seconds delay, why not thirty hours, or even thirty days, so that the B.B.C. could record everything during the day, leaving only the office-boy in the studio in the evening to shove the film through the transmitter? The public would, of course, not perceive any difference, since the programmes would, strictly speaking, be recorded ones, no matter whether they were subject to thirty seconds' or thirty years' delay.

I have even heard it suggested that the B.B.C. have long ago given up the staging of studio programmes in the evening, all being done by records made during the day or on previous days. I pointed out to my informant that this was impossible because it was quite easy to detect the difference between a first-hand or a recorded programme owing to the absence of needle-scratch, or blattnerphone-hiss in the latter. He was nothing daunted, however. He said that the B.B.C. were fully up to this, as even when there was an occasional genuine first-hand broadcast, the microphone was actually connected *via* an amplifier to a recording instrument, and the record used immediately. In other words, the B.B.C. employed a thirty-seconds' delay system.

Even so, I demurred, we should quickly find it out when there was a genuine programme of gramophone records announced as such, since we should all notice that there was no increase in the background of hiss. According to my informant, however, even this point had not been lost sight of, and on those occasions the control engineers had been instructed deliberately to mix in an extra allowance of hiss synthetically-produced. Frankly,

I don't believe it, though it is significant that the B.B.C. have refused my request to live in the studios for a week.

De Profundis

LONG had I been plagued and pestered by Mrs. Free Grid for permission to spring clean my private wireless den, it being one of the foibles of womankind, as my married readers will know, to render the house uninhabitable from time to time by an orgy of buckets and mops bestrewn everywhere. I have hitherto held out resolutely against such an invasion of my rights, but my will-power being weakened by a recent illness, I yielded to the extent of promising to move my apparatus out of the laboratory while the invading army swept in.

Accordingly I rose early one morning and duly removed my various wireless sets *en masse* on to the lawn. Then, after a hearty breakfast, I set out for the day, leaving the field clear for the enemy, first taking my usual precaution of photographing my wireless apparatus. This, by the way, is my invariable practice, as I have always found it an invaluable means of checking up on the ravages of moths during my absence. It was my intention to return in the cool of the evening and restore my treasures to their appointed places after the invading forces had done their worst and retired.

But wending my way homeward I was somewhat startled to see the evening sky lit up with a lurid glare. Soon I observed to my horror that the glare arose from my own estate.

than anything was to see Mrs. Free Grid and the little Grid Leaks calmly contemplating the blaze instead of forming a bucket chain.

It was, alas! far too late for any action on my part to avert complete catastrophe, and I had to look on helplessly while my precious possessions were reduced to ashes. The overwhelming feeling of sadness which came over me as I contemplated this lamentable spectacle of the destruction of all my hopes was completely blotted out, however, in the rage which possessed me when I learned the origin of the blaze, and I feel sure that any jury would have returned a verdict of justifiable homicide had I so far lost my self-control as to consign my womenfolk to the fast-dying embers of the fire.

It appeared that Mrs. Free Grid, with that curious lack of understanding which is common to all of her sex, had decided that the sets and apparatus I had piled up on the lawn were throw-outs intended for future destruction, and she thought she



'Looked on helplessly while my precious possessions were reduced to ashes.'

You can well imagine my dismay when I came in sight of the conflagration and realised that it issued from the pile of gear on my lawn. For a moment I had scarcely the presence of mind to use my pocket camera. What dismayed me more

start the great hobby of radio once more with a clean sheet and a completely empty laboratory like the veriest novice. Should any of you have any old components you can dispense with, I shall be extremely grateful if you would think of me.

would prepare a pleasant surprise for me by saving me the trouble of getting rid of them. As it is, I have to

Air King MODEL 213

Powerful All-wave Receiver Using Metal Valves

FOR a table model, this set has an unusually complete specification, and in some ways it may be taken as representative of the best current practice in the design of American sets. The valves, for instance, are of the latest all-metal type, and it will be seen from the view of the interior of the set that these are very considerably smaller than their glass prototypes.

The set covers three wavebands, namely, 14-52, 175-565, and 930-2250 metres. The pentode HF amplifier stage operates on all three wavebands. It is preceded by a single tuned circuit in the aerial, and the switching is so arranged that the medium- and long-wave coils are short-circuited when not in use. A rejector circuit across the aerial and earth terminals is tuned to the intermediate frequency, and a compensating resistance and condenser are switched in on medium and long waves to level up the gain on the three wavebands.

The frequency-changer is coupled to the IF amplifier through a transformer incorporating three tuned circuits. This, in addition to giving a suitable band-pass response, also assists in increasing selectivity. The output transformer from the IF stage is similarly treated, and feeds the amplified IF to a double diode second detector in which the two anodes are strapped together. AVC bias is tapped

off the diode load resistance through suitable filters and is applied to the HF amplifier and frequency-changer stages only, the IF stage functioning as a normal amplifier.

The set is fitted with a noise suppressor control, and this takes the form of a switch arranged to

FEATURES.—*Type.*—Table-model superheterodyne for AC mains. *Waveranges* (1) 14-52 metres. (2) 175-565 metres. (3) 930-2250 metres. *Circuit.*—Var.mu pentode HF amplifier—heptode frequency-changer—pentode IF amplifier—diode 2nd detector—LF amplifier—phasing valve—push-pull output pentodes. *Full-wave valve rectifier.* *Controls.*—(1) Tuning. (2) Volume. (3) Combined tone-control and on-off switch. (4) Waverange. (5) Noise suppressor. *Price.*—20 gns. *Makers.*—Air King Radio.

short-circuit the bias resistor in the cathode return of the diode rectifier. This control is operative only on medium and long waves, and a switch on the wave-range control permanently cuts out the suppressor bias when using the short-wave range.

Apart from the output transformer, resistance-capacity coupling is used throughout from the second detector to end of the set. There are two triode LF amplifiers, the first being notable for the fact that the

grid bias is obtained from a dry cell. This is of a special miniature type which has been developed in America, and it goes without saying that its employment in a mains set would not have been contemplated unless its standing life were, for all intents and purposes, unlimited. The second LF amplifier is arranged to give a balanced input to the grids of the two push-pull output pentode valves. Resistances of equal value are inserted above and below the valve in the anode and cathode circuits respectively, and a tone-control filter of the usual capacity-resistance type is connected across the input circuit of this valve.

An unusual feature of the controls is the fact that the mains on/off switch is coupled to the tone control and not to the volume control as is the convention in this country. A small-diameter clock-faced

The HF stage functions on all three wavebands. Three tuned circuits are associated with each IF coupling.

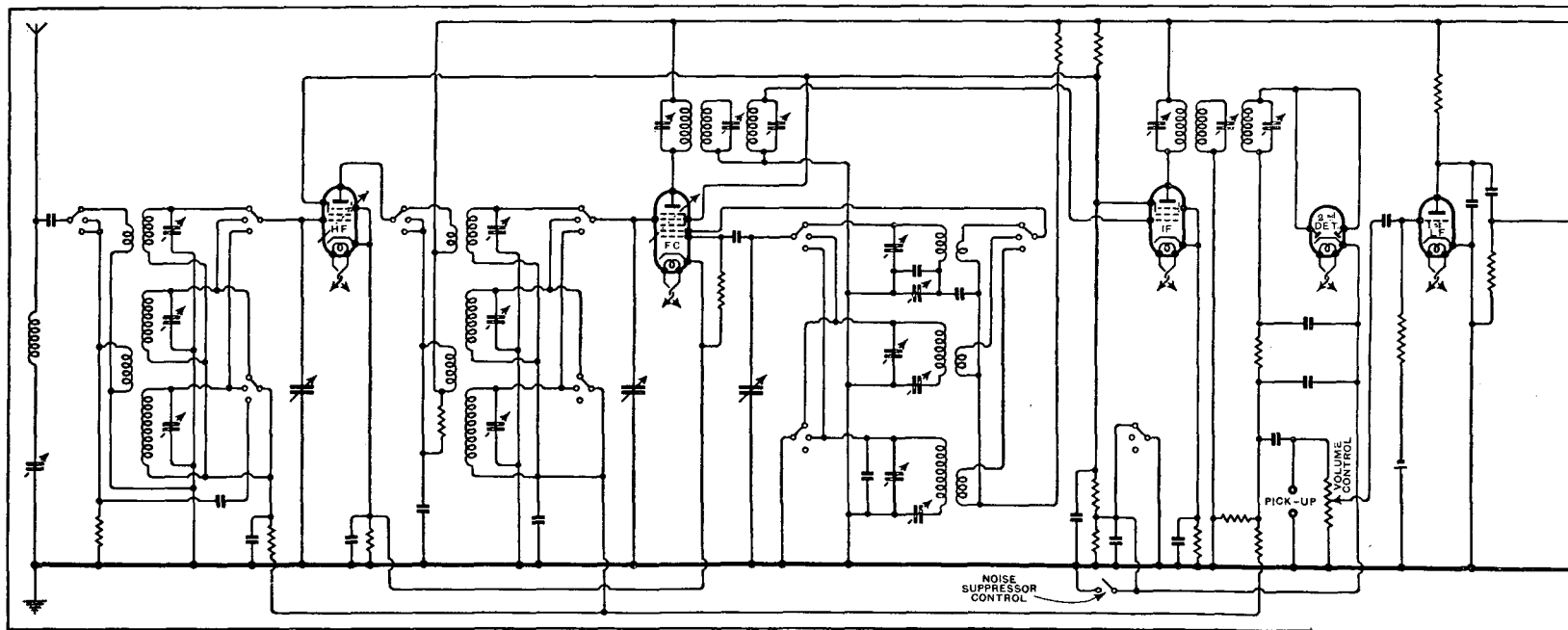
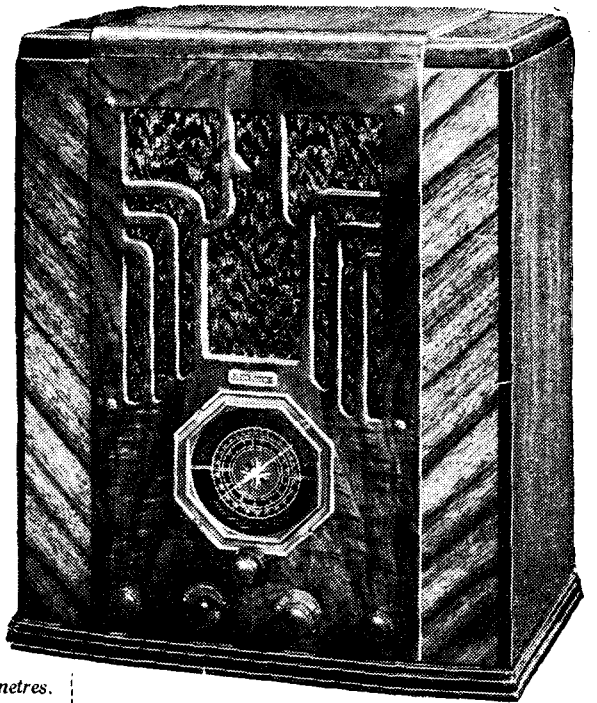

tuning dial has been specially prepared with European station calibrations. It is driven by a two-speed slow-motion device which gives admirable control on the short-wave range. Owing to the small diameter of the dial the station calibrations are somewhat crowded and difficult to read, but after a short experience with the set one is inclined to agree that the large number of stations indicated is a conservative estimate of the power of the set for long-distance reception.

It is, indeed, difficult to conceive how the overall sensitivity could usefully have been made any greater. The 9 kc/s selectivity claimed can be relied upon at all parts of the waverange with the exception, perhaps, of the local stations; but even here the spread does not amount to much more than half a channel on either side of the setting. The selectivity holds good on long waves and the Deutschland-sender can be separated from its neighbours sufficiently to rank as a station of good programme value.

Short-wave Performance

The impression of reserve sensitivity and power obtained from the medium-wave performance is strengthened when one turns to the short-wave band. The set was tested over a period of several days, and whenever an attempt was made to pick up one or other of the American short-wave stations it was always attended with success. Nowadays there is some congestion of the broadcasting channels in the region of 19, 25, and 31 metres, but no difficulty was experienced with this set in separating American stations from their more powerful European neighbours on wavelengths on adjacent channels.

A 10-inch Jensen loud speaker is used and gives a fine performance on the 8-watt output from the push-pull pentodes. This is undoubtedly the set for the long-distance enthusiast, yet the quality is such that it can be used by other members of

the family for local-station reception without any feeling that this aspect of the per-

formance has been given second place to range and selectivity.

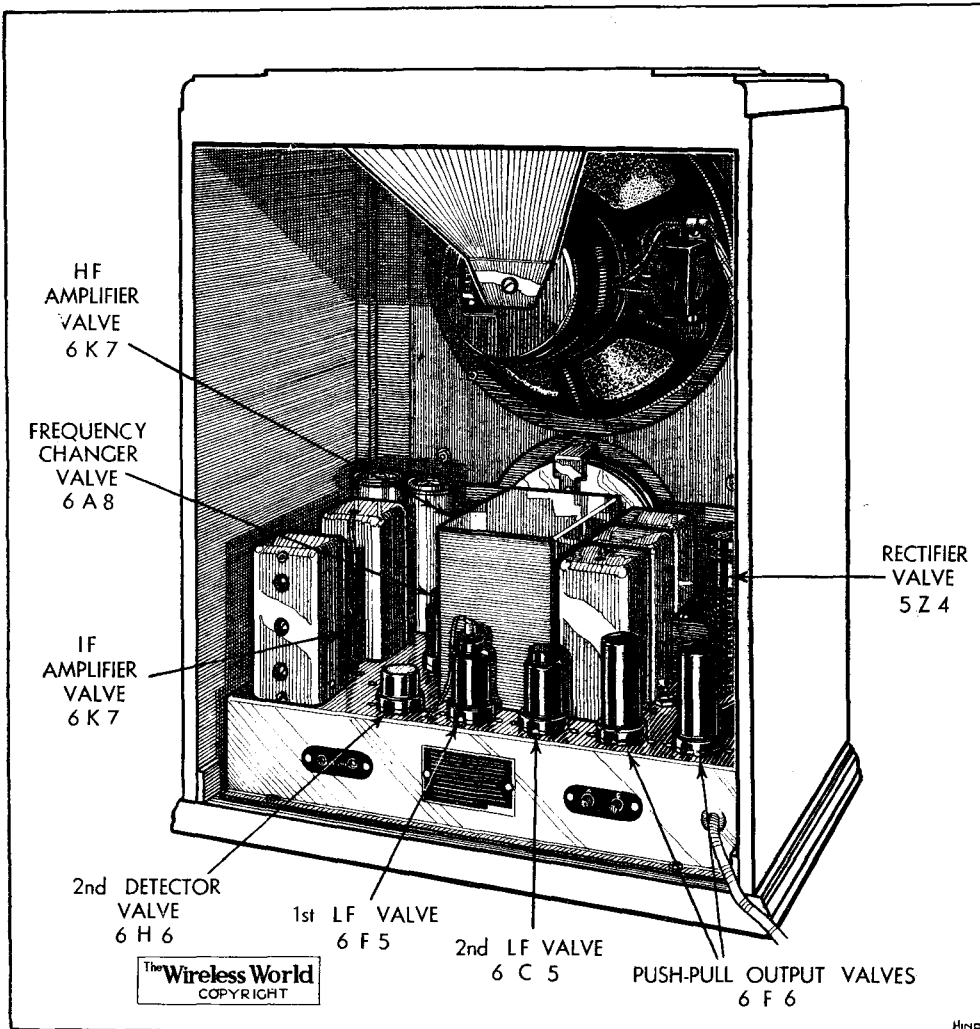

The all-metal valves are dwarfed by the normal-sized components on the top of the chassis.

At the Transmitting End

Technical Criticisms of Recent Broadcasts Are Foreign Relays Worth While?

On Sunday, December 1st, we had a concert from the National transmitter by the Hastings Municipal Orchestra and, although the standard of quality was high, it did not equal that of studio performances, which are invariably better balanced and of higher fidelity.

The falling-off in quality was especially noticeable during the songs of Laurence Holmes, the sibilants being fuzzy as well as lacking in strength.

The relay from Warsaw on December 3rd in the Regional programme was of decidedly poor quality. The higher audio frequencies were shrill and edgy, and the bass sounded very much like microphone blasting—in fact, the transmission did not even compare favourably with the B.B.C. gramophone broadcasts.

It would be very interesting to ascertain the number of listeners who heard and enjoyed this programme. It must, one imagines, be very small because the quality was not sufficiently good to hold the high-brow listener, and the others would have automatically selected the alternative ballad concert.

These relays serve no obvious purpose—

certainly little from an entertainment point of view—and, as they presumably cannot be done for nothing, the money might well be spent in providing musical transmissions from our own stations which we can enjoy.

H. C. H.

Forthcoming Criticisms.

It is hoped that the material for next week's criticism will be drawn from the following transmissions:—London National, Dec. 7th, "Music Hall"; Dec. 8th, Grand Hotel, Eastbourne; Dec. 10th, "On the Spot"; Dec. 11th, "King Arthur."

Feeder Unit for the Push-pull Quality Amplifier

IT is regretted that an error occurred in the list of parts for the feeder unit described in *The Wireless World* for August 16th, 1935. The value of the balancing potentiometer R₁ was correctly given as 1 MΩ in the circuit diagram, but appeared in error as 0.1 MΩ in the list of parts. It is important that the correct value be used, for only then is a true balance secured at very low frequencies and a complete absence of feed-back effects obtained. It is especially important when the unit couples the amplifier to the 1936 Monodial AC Super, for the use of the incorrect value may cause motor-boating.

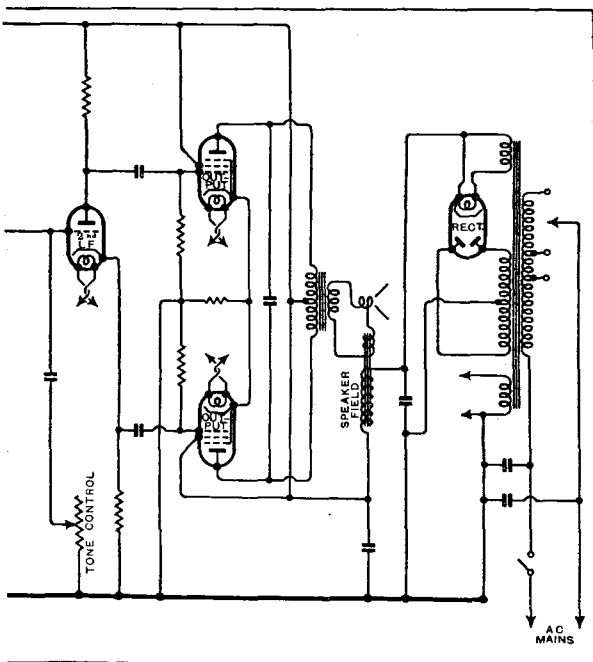

Listeners' Guide



STILL ARGUING

PEOPLE still argue as to whether such-and-such an author's works "get over" the microphone. Probably it is dangerous to generalise with the work of even one author, for, while some portions of his output may make easy listening, others may demand the concentration of a boa constrictor. A debate is still raging as to the success of Tchegov as a radio dramatist; one school considers that he was born to write for the "mike," while others aver that the visual Russian atmosphere is necessary to appreciate his plays. At all events, the early broadcasts of "The Seagull" and "The Cherry Orchard" brought a chorus of approval.

On Wednesday and Thursday next Val Gielgud is giving us a radio version of Tchegov's "Uncle Vanya," and is himself taking the part of Dr. Astrov. The unhappy Uncle Vanya will be played by Robert Farquharson, and Esmé Percy appears as Alexander Vladimirovitch Serebryahov, the Professor.

If "Uncle Vanya" is not quite so exciting as "On the Spot," it has several thrilling moments; the big scene is the one in which Uncle Vanya makes a determined attempt to shoot the professor (Wednesday, Nat., 8; Thursday, Reg., 8).

QUICK MUSIC

HIGH-SPEED programmes of the kind sponsored by Geraldo

and his Band will always have a following. To-morrow (National, 8.30) he has enlisted a squad of vocalists in addition to his band for another instalment of "Dancing Through." During the hour Geraldo will play something like 150 popular numbers in quick succession—enough to satisfy the hottest dance fan.

A MELTING MAIDEN

SINCE "The Snow Maiden," composed by Rimsky-Korsakov in 1880, was first produced in England at Sadler's Wells, three years ago, it has been frequently revived; nor will this surprise listeners who tune in the relay of the Prologue and Act I to-morrow (Regional 7.45). The fanciful plot concerns the adventures on earth of Snegourotchka, the Snow Maiden, daughter of Spring and Winter. The Sun God, in a way they have in operas, melts her with his jealous rays, and her lover, overwhelmed with grief, drowns himself.

Olive Dyer, who takes the part of the Snow Maiden, is peculiarly fitted by nature for the part of a changeling, as, besides possessing a soprano voice of wide range and great sweetness, she is well under 5 feet in height, and her diminutive and charming appearance ad-

"THE SNOW MAIDEN." The blind chorus scene from Rimsky-Korsakov's opera, Act I of which is being relayed from Sadler's Wells to-morrow. (Regional 7.45).

THE ROCKY MOUNTAINEERS present "The Mail Comes to Homewood" in another of their melodic and rhythmic programmes on Thursday next. (Reg. 7.30) The camera has caught them when about to record for Columbia.

mirably fits the rôle she has to play.

SOPHISTICATED

JEAN SABLON scored a success in the October Gala Variety; in fact, his inimitable style and rhythm caused many enthusiasts for modern music

to ring up Broadcasting House asking whose this new voice might be. Those who 'phoned, and many who did not, will be pleased to know that Jean comes to the microphone for the December Revue on Wednesday next (Nat., 10), bringing with him his "ace" accompanist, who is well known at "Bœuf sous les Toits" in Paris.

Nelson Keys will, as usual, be the leading spirit in this sophisticated entertainment, broadcast late at night so that listeners may not confuse it with the "Children's Hour."

HUNGARIAN TERROR

MODERN Budapest is the scene of C. Denis Freeman's romantic drama, "The Castle on the Hill," which is being

broadcast twice next week (Monday, Nat., 8.30; Tuesday, Reg., 8.30). Excitement there should be in plenty, for the tale deals with the Hungarian Terror of 1919. However, things may not be so bad as they seem, for the B.B.C. Theatre Orchestra and Wireless Chorus are taking part, and the cast includes Effie Atherton and Carol Goodner. That fine singer, John Rorke, appears as a butler.

MELODIOUS CONTRASTS

COMPARISONS are seldom odious, as has been proved again and again in broadcasts of contrasted dance bands in the same studio, and in the admirable "Songs from the Shows" series. Another of the latter will be given on Thursday next (Nat., 8.30), when the tuneful compositions of those two popular composers, Ivan Caryll and Vincent Youmans, will be set in contrast. There is a variegated cast, including, among others, Esther Coleman, Wynn Ajello, Brian Lawrence, Eda Peel, and the Three Ginxs. Harry S. Pepper and Doris Arnold will be at the pianos, and the B.B.C. Variety Orchestra will be in support.

OPERA ABROAD

WAGNER is well represented in the week's broadcasts. Budapest No. 1 is relaying Acts II and III of the Royal Opera performance of "Lohengrin" at 7.10 this evening



de for the Week Outstanding Broadcasts at Home and Abroad

HIGHLIGHTS OF THE WEEK

FRIDAY, DECEMBER 13th.
Nat., 7.30, "Young Ideas." 8.30, "Mrs. Buggins Sees Stars." 10, Viscount Snowden on "Keir Hardie."
Reg., 8.40, "Ship Canal" (from Manchester). 10.10, Sydney Kite and his Band.

Abroad.

Radio-Paris, 8.45, Operettas: "L'enfant prodigue" (Wormser); "Mam'zelle Nitouche" (Hervé).

SATURDAY, DECEMBER 14th.

Nat., 7, Saturday Magazine. ¶Dancing Through. ¶Ambrose and his Embassy Club Orchestra. Reg., 7.45, "The Snow Maiden" (from Sadler's Wells). ¶Violin Recital by Jean Pougnet.

Abroad.

Cologne, 7.10, "Gesang ins Glück" (Kauffman)—an operetta for radio.

SUNDAY, DECEMBER 15th.

Nat., 2.45, Eugene Pini and his Tango Orchestra. ¶Organ Recital by Berkeley Mason. ¶B.B.C. Theatre Orchestra.

Reg., 6.30, Troise and his Mandoliniers. 9.20, Oratorio, "Solomon" (B.B.C. Orchestra and soloists).

Abroad.

Leipzig, 5, Wagner's "Ring"—II: "Siegfried."

Berlin, 7.45, Sibelius Gala Concert.

MONDAY, DECEMBER 16th.

Nat., Violin Recital by Antonio Brosa. 8.30, "The Castle on the Hill" ¶Billy Cotton and his Band.

Reg., Celebrity Trio. ¶Meet Mickey Mouse. 9.30, Medvedeff's Balalaika Orchestra.

Abroad.

Kalundborg, 7, Aarhus Philharmonic Concert of New Danish Music.

TUESDAY, DECEMBER 17th.

Nat., 8.15, B.B.C. Orchestra, conducted by Adrian Boult. ¶Lew Stone and his Band.

Reg., Victor Olof Sextet. 8.30, "The Castle on the Hill." ¶Piano Recital by John Wills.

Abroad.

Munich, 6.30, Gala Concert of New German Music.

Paris PTT, 8.30, French National Orchestra.

WEDNESDAY,

DECEMBER 18th.

Nat., B.B.C. Dance Orchestra. 8, "Uncle Vanya" (Tchehov). 10, Nelson Keys in December Revue.

Reg., 8.15, The Story of the Waltz (B.B.C. Theatre Orchestra). ¶B.B.C. Military Band.

Abroad.

Königsberg, 7.45, Fairy Opera: "Hansel and Gretel" (Humperdinck).

THURSDAY, DECEMBER 19th.

Nat., 8.30, Songs from the Shows. ¶B.B.C. Orchestra, conducted by Julius Harrison. ¶Jack Jackson and his Band.

Reg., Bill Campbell and the Rocky Mountaineers. 8, "Uncle Vanya." ¶New Georgian Trio

Abroad.

Berlin, 7.10, "Berlin Nonsense"—a gala revue.



JACK JACKSON AND HIS BAND will broadcast the late dance music from the Dorchester Hotel on Thursday.

(Friday); on Sunday Leipzig offers "Siegfried" at 5, and Munich at 7.10 on Thursday next gives excerpts from "Lohengrin," "The Flying Dutchman," and "Tannhäuser."

To-morrow brings Masenet's "Ariane" to listeners by way of Radio-Paris at 8.45. Christopher Columbus—a new character in opera—is the subject of an epic poem by Kozik for which music has been composed by Paul Haas, a very modern Belgian, and the work is being broadcast by Brussels No. 1 at 8.30 to-morrow.

Another example of the modern school—Italian this time—can be heard on Rome at 9 the same evening, viz., "Sir Oluf," a two-act opera by Malatesta, the young composer-conductor.

OPERETTA

Two famous operettas clash at 8 to-morrow. Brussels No. 2 is offering Kalman's delightful "Little Dutch Girl," while Hilversum (Kootwijk) gives us "Die Fledermaus" (Johann Strauss).

Of special interest is an operetta specially written for broadcasting which Cologne is giving at 7.10 on Saturday. This is "Gesang ins Glück" (Sung into Happiness), Kauffmann being the composer. Oscar Strauss' "Waltz Dream" comes from the Radio-Paris studio at 8.30 to-morrow.

No week would be complete

without a Lehár operetta. At 7 on Thursday next Warsaw is giving concert versions of "Frasquita" and "Giuditta."

ADVENT

The season of Advent is, of course, reflected in the current programmes abroad. To-night Beromünster offers Advent music at 6.50. To-morrow Handel's "Messiah," rendered by the Dublin Philharmonic Society, figures in the Athlone programme at

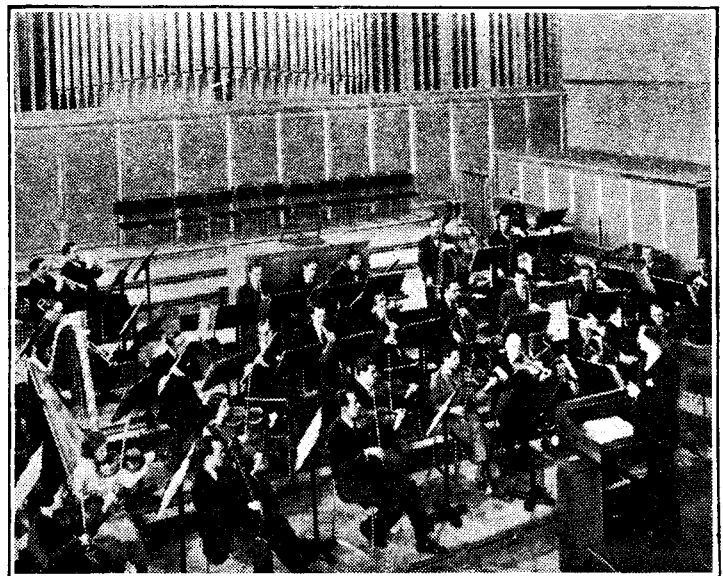

MUSIC FROM SOTTENS. The West Switzerland radio orchestra broadcasts regularly under the direction of M. Hans Haug.

7.30. A little earlier we can tune in the Brussels No. 2 relay of a recital by the "Harmonia Parnassia" from the Church of the Holy Ghost, Brussels (5).

MUSICIANS' NIGHT

NEXT Thursday is probably the best night for the musical highbrow. At 5 Walter Niemann plays his own piano-forte compositions in the Leipzig programme. At 7.10 Berlin (Deutschlandsender) features the Elly Ney Trio. Beethoven and Schubert Quartets are in the Leipzig transmission at 9.20, while at 10 Munich has music for a Chamber Orchestra composed and arranged by Gerhard Maasz, the well-known Music Director of Hamburg.

MUSICAL TOURING

The new vogue of musical touring is being taken up by Vienna and Deutschlandsender. To-morrow afternoon the 3.45 Vienna concert consists of Albanian, Bulgarian, Ukrainian, Circassian, Georgian, Armenian, Kurdish, Spanish and Syrian folk music; the German station at 6 p.m. offers listeners a colourful musical journey from the Danube to the Volga.

SPECIAL ITEMS

LEIPZIG, Monday, 8: Musical Fireworks.

Vienna, Saturday, 7.5: "Music of the Nations"—a Gala Concert.

Warsaw, Wednesday, 10.30: English Talk on Polish Winter Sports. THE AUDITOR.

New Apparatus Reviewed

Recent Products of the Manufacturers

NOISE-MASTER ALL-WAVE AERIAL

THIS aerial system is designed for use in locations where electrical interference, other than the atmospheric types, is sufficiently troublesome to preclude satisfactory reception, and there is definite proof that it is due mainly to direct pick-up by the aerial leads. As a general rule it is the down lead that contributes most to the interference, and, incidentally, least to the signal strength, and in the Noise-Master system the down lead is designed to act merely as a feeder of low impedance, so that if the horizontal part of the aerial can be raised above the interference zone, or located well away from buildings in a relatively noise-free area, the lead-in can pass through the interference field and yet be unaffected.

The components parts of the kit comprise two 30ft. coils of 7/24 aerial wire, 50ft. of twisted pair down lead, aerial and receiver transformers, insulators, and all fittings.

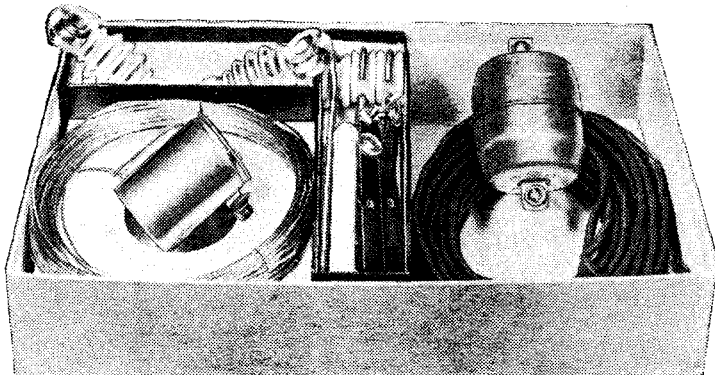

Noise-Master aerial kit designed for use with all-wave receivers.

The aerial arrangement is known as a doublet and consists of two equal lengths joined in the middle by a matching transformer. The other transformer is located as close as possible to the receiver and forms the lower termination of the feeder.

This particular aerial kit is designed to function on all broadcast wavelengths, including the short waves.

From tests made it can be said that the aerial is perfectly satisfactory on all wavelengths from 12 to 2,000 metres, and that good rejection to interference is obtained. In some cases the actual strength of signals may be somewhat less than with an orthodox aerial, but as the signal-to-noise ratio, which is the principal factor, is so very much better, the effective signal strength is greater, and this applies to the whole wavelength covered by an all-wave set.

This aerial kit is obtainable from R. A. Rothmel, Ltd., and the price complete is 45s.

"VELEX" RIBBON MICROPHONE

FUNDAMENTALLY the ribbon microphone is similar to the moving coil pattern, only in place of the customary coil is a very thin and light strip of foil located edgewise between the pole-pieces of a powerful magnet. The sound waves act directly upon the ribbon, which vibrates in the magnetic field, and the voltages so generated in it are stepped up by a

suitable transformer and then amplified in the usual way.

In the "Velex" Velocity Ribbon microphone four separate ribbons connected in series are used, it being claimed that with this arrangement a larger output than usual with ribbon microphones is obtained so that fewer amplifying stages are needed. Being fitted with a permanent magnet it does not require an energising battery.

For general use a good three-stage resistance amplifier will provide all the amplification needed.

The overall frequency response, including the transformer, is quite good, especially in the bass, where the average level is higher than elsewhere. From 500 to 10,000 c/s the output can be regarded as sensibly constant. The rising characteristic of the bass culminates in a peak at about 150 c/s, this being the one and only resonance of any consequence noticed during our tests. It is not serious and may even pass un-

noticed under normal conditions of use.

There is a shallow trough at 70 c/s, though the level here is then of about the same order as at 1,000 c/s. This output level is then maintained down to 50 c/s, below which we did not explore.

It gives very natural reproduction both on speech and music. Considering the nature of the

design and its most satisfactory characteristics, the price, which is £9 9s., is very reasonable.

STERLING HT BATTERY

A NEW range of HT batteries bearing the description Sterling "Square-Cel" has been introduced by Sterling Batteries, Ltd. These are fitted with square-section cells

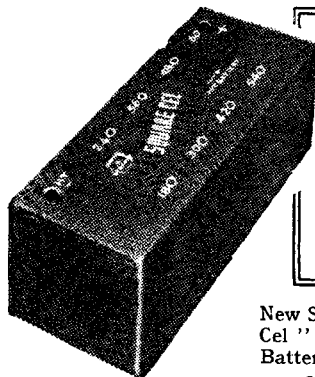

New Sterling "Square-Cel" 60-volt HT Battery with its discharge curve.

which in the 60-volt unit tested measured $\frac{3}{4}$ in. \times $\frac{3}{4}$ in. \times $2\frac{5}{8}$ in. high, 42 such cells being accommodated in a battery $9\frac{1}{2}$ in. long, $3\frac{3}{4}$ in. wide, and $3\frac{1}{4}$ in. high.

The amount of active material that can be employed is, therefore, greater than if the cells were of cylindrical form and of

"Velex" Velocity Ribbon microphone.

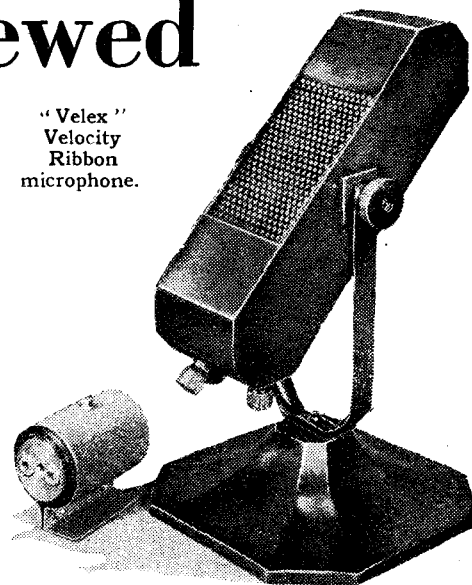

diameter equal to one side of the square type, yet both would occupy the same cubic capacity when assembled in the manner usually adopted in battery construction.

The result of our tests, as shown by the discharge curve, shows that the useful life of the battery is about 380 hours. Whilst this is somewhat longer than the average, when discharged at the optimum rate, the most important feature is that the voltage is maintained at a relatively high level throughout the greater part of the period. For the first 230 hours the voltage did not fall below 50 under conditions of use far more severe than usual, for our practice is to discharge the battery in periods of four hours with like intervals only for recuperation. Only the actual working hours are included on the graph.

The arbitrary end-point in the case of this battery is very near to the actual exhaustion point, for it can be seen by the shape of the curve that it will not survive for much longer.

An exceptionally good figure of 105 watt hours was obtained from these tests, giving to each cell 2.5 watt hours, a figure well above the average for a battery of this size.

There is no doubt that the new Sterling battery will give long service under normal operating conditions. Yet it is reasonably priced, the 60-volt model costing 5s. 6d. Tappings are provided at 18 volts, thence at 6-volt intervals to 60 volts.

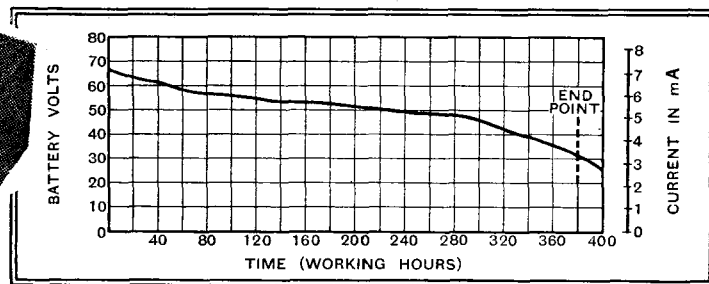

Handbook of the Radio Direction Finder. By Commander F. G. Loring, O.B.E., M.I.E.E. Practical notes for the guidance of users of direction finders, without reference to theory. Methods of calibration and the properties of the direction finder as an aid to navigation are treated. Pp. 24, with supplementary list of radio beacons throughout the world. Published by The International Marine Radio Co., Ltd., and sold by Electrical and Radio Publicity Service, Albion House, 59-61, New Oxford Street, London, W.C.1. 2s. net.

BROADCAST BREVITIES

By Our Special
Correspondent

A Mass "Interview"

SIR STEPHEN TALLENTS is to be congratulated on having, so early in his B.B.C. career, inaugurated the mass "interview," whereby representatives of the Press—daily, periodical, technical—are permitted to let fly questions at some prominent official of the Corporation.

Last week it was Mr. Cecil Graves, Director of Programmes, who braved a critical though kindly audience in the shadowy Conference Chamber.

The Velvet Glove

With a pleasing diffidence which really concealed an iron grip of each situation as it arose, Mr. Graves had an answer for everybody; he gave satisfaction to those who clamoured for more Variety without displeasing a minority who obviously represented the severely musical listener, and even came out creditably from an exciting cross-examination on the relative brightness of Sundays in Luxembourg and Portland Place.

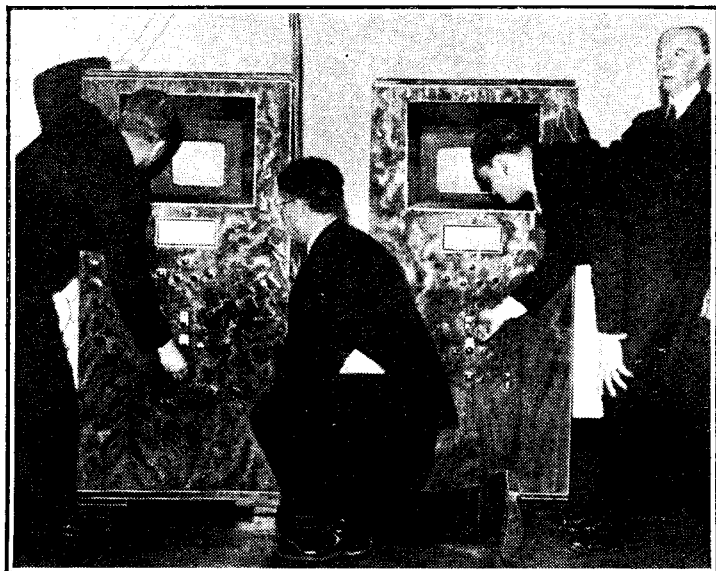

FRENCH TELEVISION—In pursuance of his energetic plans to make France "television-conscious," the Postmaster-General, M. Mandel, is now installing demonstration receivers in various parts of Paris. Above are receivers undergoing initial tests.

Quart Into Pint Pot?

Naturally, with so many inquisitors, Mr. Graves made a statement or two which seemed less convincing when I turned them over in my mind in Regent Street half an hour afterwards. For instance, he made the seemingly incredible promise that more Variety would be introduced into the programmes with-

out sacrificing any other features—an undertaking which suggested that the atmosphere of the recent election campaign is not yet entirely dissipated.

Innovations to Come

On the whole, Mr. Graves convinced everybody, I think, that programmes will continue on the up-grade. He emphasised that there can be no great upheavals for three or four months, for the simple reason that programme commitments run on into the early summer, but I feel sure that, twelve months hence, the general complexion of British broadcasting will have greatly changed. An 11.30 p.m. news bulletin is only one of many innovations we may expect in the New Year.

Plea for New Plays

Programmes are to be shorter and "snappier." Two-hour symphony concerts will go, and so will the ninety-minute radio play. The trouble with the latter is the famine of original microphone material.

"We need new plays more

than anything," pleaded Mr. Graves, and I am afraid he will continue to plead until the B.B.C. sees fit to pay good money for good stuff.

A New Year "Mosaic"

I HEAR that Laurence Gilliam is preparing a "Mosaic" programme to usher in the New

Year, obtaining his effects by unusual "shots" of representative gatherings all over the British Isles and even, perhaps, at sea and in the air. "Chimes at Midnight" will be the title of the feature, which will begin at 11 p.m. on December 31st.

There will be little or no moralising, the idea of the programme being to reflect the jolly, optimistic family spirit of the Anglo-Saxon greeting a New Year.

From Land, Sea and Air

A shepherd on the Moors may breathe his thoughts into the microphone; a village family circle may be overheard chattering before the log fire; a sailor at sea and a pilot over the Channel may also "say their bit"—and these shots will be interspersed into the framework of the main programme.

On the Steps of St. Paul's

At 11.45 listeners will be taken to St. Paul's Cathedral for the Watchnight Service conducted by the Dean, the Rev. W. R. Matthews. As the last sounds of the service die away, Big Ben will ring in the New Year. Immediately afterwards we shall be switched back to the steps of St. Paul's to hear the crowds singing and dancing. The B.B.C. describes this episode as a delightful Cockney pattern, but I fancy we shall hear the Caledonian variety more than any other.

North of the Tweed

A few minutes later the sound of the bells from the Guildhall, Berwick-on-Tweed, will be faded in, followed by more Scottish voices rejoicing outside the Tron Kirk, Edinburgh. Rounding off the programme will come the strains of "Auld Lang Syne."

Discontented Producers

THE time when the studios at Broadcasting House are converted into administrative offices seems to be drawing rapidly nearer.

Discontent is noticeable among producers and others at headquarters who have visited Maida Vale and listened to the glowing stories of all that is being done at the Alexandra Palace.

Sound Leakage at Portland Place

Most of the Portland Place studios are too small, and recently there have been alarming



[Photo: Leslie Baily.]

BANGOR CALLING—The B.B.C.'s new North Wales studio is now in use. Above is a snap of Mr. Hett (left) engineer-in-charge, and Mr. Sam Jones, programme representative.

indications of sound leakage. The Concert Hall is, of course, a notorious offender; when an organ recital or rehearsal is in progress the louder passages seem to reverberate throughout the building. Many a time when I have been discussing variety programmes and other frivolous matters with the officials the swelling notes of the organ have given me the feeling of being a brawler in a cathedral.

The Smoke Bomb

Proof of this leakage came in unexpected fashion not long ago, when a variety producer let off a smoke bomb in the "Effects" studio. The smoke penetrated the ventilation system and caused acute distress, not to say alarm, to a venerable occupant of a talks studio three floors up.

The ensuing "Unrehearsed Debate" was not broadcast.

Multi-Studio Methods

Rehearsals absorb a tremendous amount of studio accommodation, which is not surprising when we remember that every feature programme entails at least half a dozen rehearsals, sometimes involving four or five studios simultaneously.

Last-minute Rehearsals

The fact that a studio is booked for an hour's broadcast does not mean that it is in use for only sixty minutes. As often as not the studio is required for twice the period of the actual broadcast.

More and more artists are coming to recognise the value of rehearsing "up to the minute," and the tendency therefore is to book the studio for an hour before the control-room signalling light changes from blue to red.

Hyvoltstar Ten

THE modern trend in receiver design towards simplification of controls is leading inevitably towards a certain standardisation of performance. Sets which reward skilful operation with a proportionately higher performance are becoming few and far between. While it cannot be denied that the average superheterodyne gives all the entertainment value that most listeners ask, there will always be enthusiasts who feel the urge to excel in long-distance reception. It is gratifying to find that sets of the calibre of the "Hyvoltstar Ten" are still available for this by no means in-

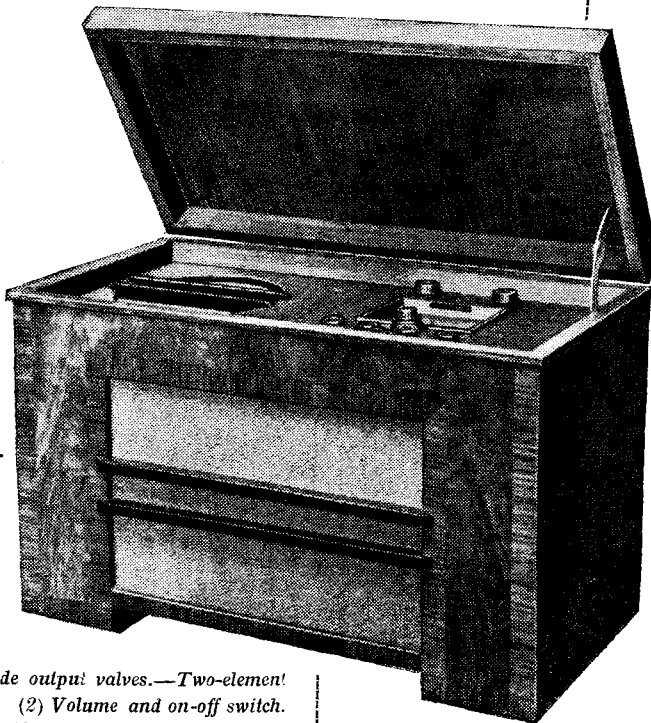

A HIGHLY DEVELOPED ALL-WAVE RECEIVER WITH UNIVERSAL VALVES

FEATURES.—Type.—All-wave superheterodyne for AC or DC mains. **Waveranges.**—(1) 13 to 33 metres. (2) 28 to 73 metres. (3) 200 to 560 metres. (4) 800 to 2,200 metres. **Circuit.**—HF amplifier—heptode frequency changer—two stages of IF amplification—double-diode second detector—1st LF amplifier and QAVC valve.—2nd LF amplifier—push-pull pentode output valves.—Two-element half-wave valve rectifier. **Controls.**—(1) Tuning. (2) Volume and on-off switch. (3) Waverange. (4) Tone. (5) Sensitivity. (6) Variable Selectivity. (7) Automatic Silencing. (8) Neon adjustment. **Price.**—35 guineas. **Makers.**—Universal High Voltage Radio Ltd.

controls in order that this maximum performance can be modified and adapted to any type of transmission or set of receiving conditions.

Excluding the rectifier there are no fewer than nine valves in the circuit. The first operates as a signal frequency HF amplifier on each of the four wavebands.

Besides contributing considerably to the overall sensitivity this valve also gives an improvement in the signal-to-noise ratio, which must be carefully considered throughout the design when so high a performance is aimed at. In the anode circuit of this valve is a relay associated with the QAVC stage.

considerable section of the listening fraternity, and while such sets are available there is no fear that manipulative skill in tuning will become one of the lost arts.

In saying this we do not wish to infer that the set is in any way difficult to operate. Average tuning skill will, in fact,

produce more than average results. The point of view which the makers have adopted has been to make the sensitivity as high as it can be without instability and then to provide a sufficient number of con-

An HF amplifier working on all wavebands and two stages of IF amplification provide a high overall sensitivity. The push-pull output stages are fed from a separate element of the dual half-wave rectifier.

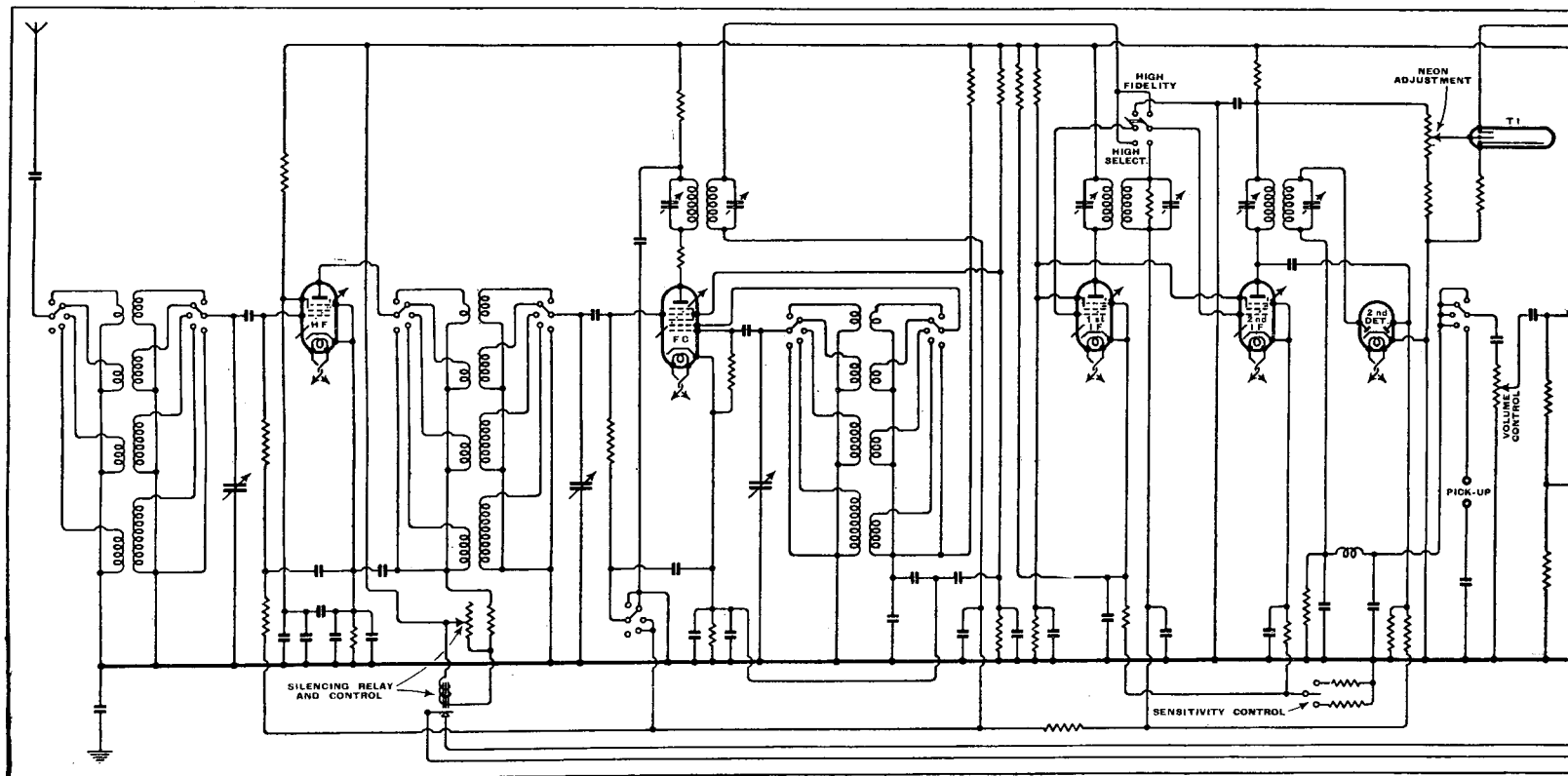

Hyvoltstar Ten—

The frequency-changer is a valve of the heptode type and is controlled from the AVC line on the medium and long wavebands only. The HF and IF stages are, of course, controlled on all four wavebands. There are two stages of IF amplification and a change-over switch has been arranged to cut out the first stage, together with its coupling transformer. In this way it has been possible to provide a sufficiently high selectivity to make use of the full amplification of the set and at the same time to provide a wide range of audio frequency response when the best possible quality of reception from the local station is required.

A two-way switch is provided to vary the standing bias on both IF valves in order to give some reduction of sensitivity for ordinary everyday listening. In the high sensitivity position matters have been so arranged that the IF stages additional magnification which would be unnecessary for ordinary reception.

The second IF valve, which is always in use, supplies the voltage for actuating the neon tuning indicator. This is provided with an adjustment so that the range of indication can be adapted to strong or weak signals. The valve in the second detector stage is a double-diode, in which the connections of both signal rectifying

and AVC circuits are perfectly straightforward. Incidentally, there is no delay voltage on the AVC system, but its time

the cathode circuit of the QAVC valve, which puts it out of action as an amplifier. When a signal of sufficient strength is

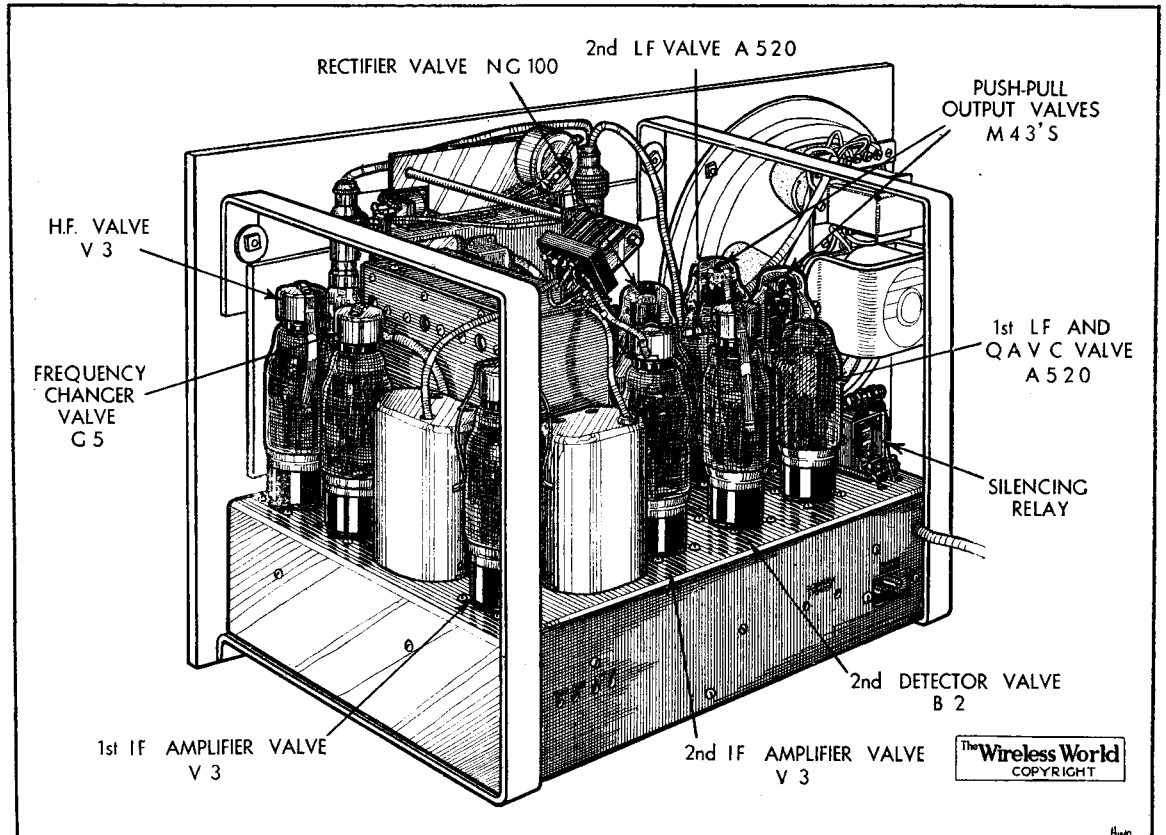

Chassis and loud speaker form a single unit, the control panel of which is horizontal when fitted into the cabinet. The mains resistance is mounted separately on the floor of the cabinet.

constant has been made shorter than usual in order to cope with rapid fading on the short waveranges.

The triode valve following the second detector is devoted to noise suppression between stations. With no signal on the aerial the relay in the anode circuit of the HF amplifier opens a high resistance in

received these contacts close and the greater part of the bias resistance is short-circuited, so that the valve functions under normal conditions. Circuits are associated with the grid to give a slight delay to the opening and closing of this valve. The point at which the relay operates is adjustable by means of a variable resistance shunting the magnet winding.

A further stage of resistance coupled LF amplification is interposed between the QAVC valve and the push-pull output pentodes. The intervalve transformer feeding the grids of these valves is parallel fed, and a tuned filter is included in series with the primary to suppress the 9 kc/s heterodyne whistle between stations on adjacent channels.

Dual Rectifier

A tone control circuit bridges the two anodes of the output valves and there is provision for a high impedance external loud speaker, which is fed through condensers. The field of the moving coil loud speaker is connected across the output from the rectifier, and a separate choke is used for smoothing. The rectifier valve consists of two separate elements, one of which is used to supply the HT current to the output stage and the other to the remaining valves in the receiver. The heaters of the valves are of the high voltage type and are all fed in parallel, a series resistance with suitable tappings being included to adapt the set to AC or DC mains voltages between 200 and 260 volts. Filter

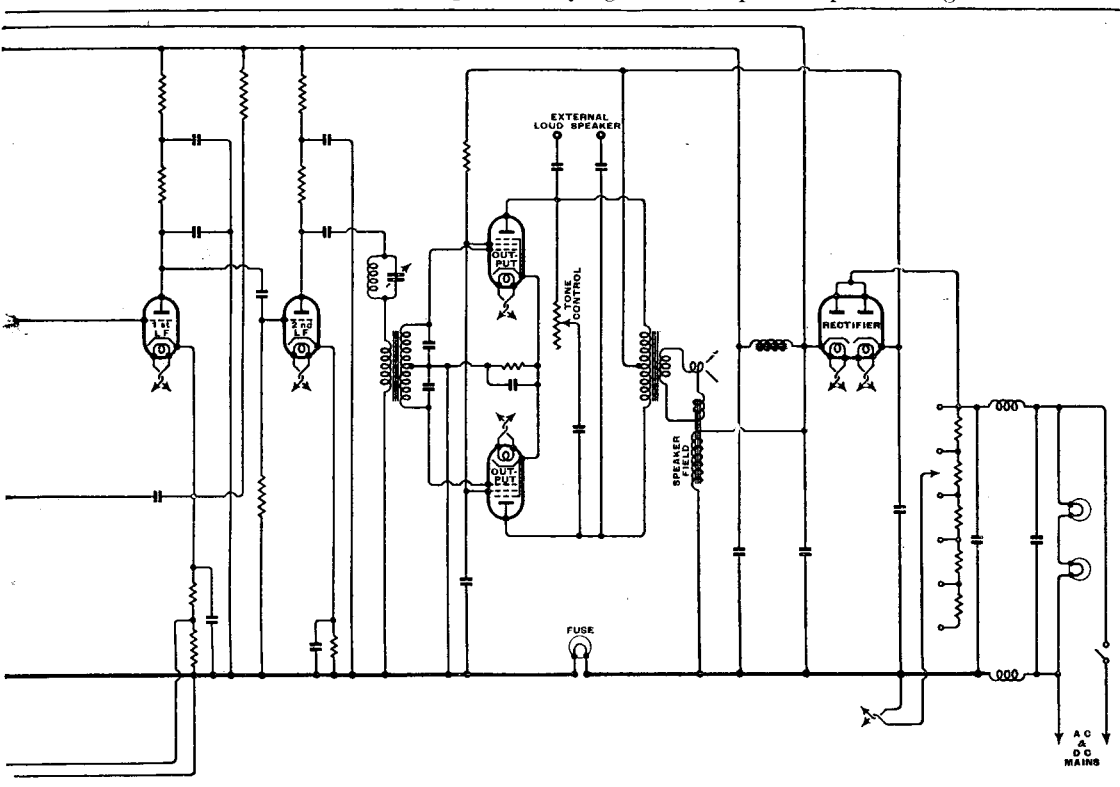

Hyvoltstar Ten—

chokes and condensers are included in both mains leads, and the dial lights, which are also of the high voltage type, are connected in series directly across the mains.

On all four wavebands the sensitivity is such that every station which is above the prevailing noise level can be received with an ample reserve of amplification in hand for such times as the atmospheric noise level may show an improvement. It is in this respect that the set shows to the greatest advantage over ordinary receivers in which an arbitrary limit has been put to the sensitivity in the interests of a quiet background.

With the variable selectivity control in the high selectivity position it is possible to approach within half a channel of the Brookmans Park transmitters when using the set in Central London. Under the same conditions and with the tone control suitably adjusted the Deutschlandsender could be received with hardly any side-band interference from its neighbours. The set is quite free from self-generated whistles, and the AVC keeps a firm control over the very wide range of signal strength which the set is capable of handling.

When tuning the set it is advisable to start with the sensitivity control in the low position and with the automatic silencing control out of action. After a few stations have been received the automatic silencing knob may be adjusted. The neon tuning adjustment and possibly the tone control will, of course, have to be set to obtain the best results from each individual station. The tuning scale, which is of the clock-face type is actuated by a two-speed control knob with alternative reduction ratios of 15:1 and 100:1. The latter is most useful on the short waveband where there is now some crowding of the bands allocated to broadcasting stations.

The controls form a compact group round the tuning scale on the right-hand side of the horizontal tuning panel. The left-hand side is occupied by the loud speaker grille, a somewhat unconventional arrangement in which reflection of sound from the open lid of the cabinet is relied upon. The grille on the front of the cabinet serves merely to relieve the sound pressure in the inside of the cabinet. This arrangement gives an excellent distribution of sound without any suggestion of focusing of the high frequencies.

As might be expected with so high a sensitivity, it is possible to overload the output stage, but not before considerably more volume is obtained than is required for the average sized room. On speech there was a tendency to over-emphasis of sibilants unless the tone control was turned down, and for the reproduction of music from the majority of stations best results as regards balance were obtained with the tone control approximately in the mid-position. The bass response goes down well below 100 cycles, and in this region showed no evidence of frequency doubling. There was also a complete absence of boom either from the fundamental resonance of the loud speaker unit or from cabinet resonance.

The whole of the receiver unit, together with its loud speaker, can be lifted out for inspection and stout iron brackets enable the chassis to be laid in any position without damage to any of the components.

This is pre-eminently a set for those who make a serious hobby of distant reception, and the number and variety of controls provided enable a high maximum performance to be modified to suit any conditions.

Forthcoming Reviews:—**HEYBERD 4-POINT RECEIVER****SCOTT HI-FIDELITY ALL-WAVE SUPERHET****Letters to the Editor**

The Editor does not hold himself responsible for the opinions of his correspondents

HOME RECORDING

I AM extremely glad to see that *The Wireless World* is awakening interest in home recording. I have for some time been experimenting with the Ekco Radiocorder, which, although no longer manufactured, I was able to buy in separate parts from dealers. Several records have been highly successful, but the main difficulties lie in the recording disc: aluminium, in my opinion, is not at all satisfactory, and I do sincerely hope that your article in *The Wireless World* will lead manufacturers to supply cheap composition records, that is to say, discs with a soft wax surface which can be hardened by baking after recording.
Cambridge. H. GELLATLY.

I READ with interest your remarks in the issue of November 29th regarding Home Recording. I have been experimenting with various systems for the past three or four years, but have been forced to certain conclusions, bearing in mind that in my view Home Recording means the completion of the process by oneself with the smallest possible expense and minimum of trouble.

I am convinced that to obtain anything like reasonable results must entail an expenditure of £15 and upwards, anything below that figure giving results that can only have novelty value. The chief trouble with low-priced systems being their use of blanks with a metal surface; these have a very short life, even though used with fibre or similar needles (as they must be). Furthermore, they are only practicable in small sizes due to the needles rapidly losing their edge.

The greatest difficulty, however, is that of obtaining suitable tracking devices, motors and turntables. The average low-priced motor on the English market does not seem to have the power for cutting the outer edge of a 10in. record; you thus get a small but steady increase in speed as the record works towards the centre, the result being a noticeable alteration in pitch when reproducing. Secondly, there is the question of mechanical vibration in the motor being carried through the spindle to the turntable. For even moderate results the spindle must be insulated from the turntable. Regarding the tracking device, it is my experience that they all either possess when new or develop with little use a certain amount of side play on the drive, resulting in uneven cutting of the grooves, and in some cases cutting into the next groove. There are on the American market machines in which the above points have been attended to, but they are not obtainable in this country at the present time. I

am, therefore, convinced that if some English manufacturer will put out such apparatus he will find a profitable market for it, but it must not be of the novelty class; we have had enough of these in the past; the very fact that they are practically all extinct shows the public's opinion of them.
J. QUARMBY.

Oldham.

I HAVE been interested in home recording for some time, and am looking forward to some useful correspondence in response to your paragraph on the subject.

My results so far have not been satisfactory, although promising. My principal difficulty has been the running of one groove into another, due to slight sideplay in the traverse mechanism; this has taken place on three different makes of recorder—one mechanical, the others electrical. I have as yet been unable to remedy this to my satisfaction.

I have only tried plain aluminium discs, with paraffin as lubricant, but I think there is considerable need for improvement in that respect. Two different types of diamond stylus and a steel stylus seem to give very similar results, except that the steel type, of course, wears quickly. I use a home-made recording head, devised from a small loud-speaker unit.

Another difficulty is that the 2½ watts output which I have available is not sufficient to record at a sound level high enough to render scratch reasonably insignificant.

There is also a disconcerting tendency for the motor to run unevenly, or even to stop altogether, if the weight on the stylus is excessive, with the result that the depth of groove which I have been able to obtain is barely adequate to retain the reproducing needle (Burmese colour, in Rothermel Piezo-Electric Pick-up). Perhaps other types of motor would be found more satisfactory, although one can scarcely blame any motor for being unable to do a job for which it was not designed.
A. M. SIBUN.

London, S.E.6.

YOUR suggestion to readers to state their experiences with home recording outfits should produce interesting correspondence, if only readers will write to you and not keep their experiences to themselves selfishly.

Many of us would like to record successfully. What we want to know first is what apparatus can be bought and at what price and where. I have not seen anything of the kind advertised for a long time.

Croydon.

B. H. SMITH.

"Just Think What Two Can Do!"

Suggestions for Promoting Domestic Peace

By "CATHODE RAY"

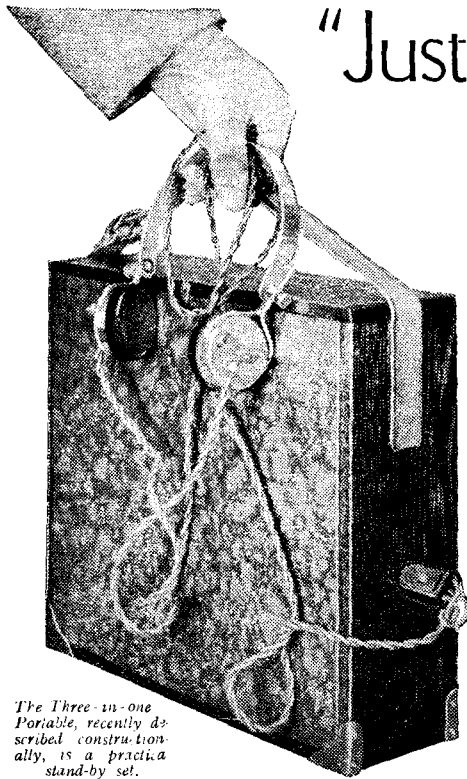

The Three-in-one Portable, recently described constructionally, is a practical stand-by set.

Extract from an American radio journal:

"It is reported that there are over two million families in the United States with two or more radios."

It is not reported who reported this, or on what authority it was reported, but I have no difficulty in believing it. Before me is a catalogue which lists a self-contained 4-valve universal all-mains receiver, a good-looking job, with illuminated "airplane" dial, complete with valves (including three pentodes); retail price ("Your Cost," as it puts it) \$6.95; at the current rate of exchange, twenty-eight shillings and threepence. An all-wave superhet, however, costs nearly four guineas in our money.

In such a market the wonder to me is that only a mere two million possess more than a solitary set per family. Obviously the depression is not yet quite over in those parts.

Here, the situation differs in substantial respects. The valves alone for a 4-valve set would cost us considerably more than double the price of the complete outfit just mentioned. Even at level prices one expects more purchasing hesitation on the part of our own population, who are less at the mercy of high-pressure salesmen than are our American cousins.

The Stand-by Receiver

But I absolutely agree with the multi-set policy. Perhaps the readers of *The Wireless World*, being imbued with a strong experimental urge, are the least likely to dispute this doctrine. Where a household comprises not less than one member of this type it needs very little experience to demonstrate that the single-set situation is an impossible one.

The non-technical member or members of the family are not usually so far in sympathy with the aims of science as to accept with gratification the news that some cherished programme cannot be received because the one and only set is being used to compare the performance of the triode-hexode with that of the heptode and is at the moment in a transitional state.

The vital necessity for maintaining at least one working receiver per home is obvious. But when that condition has been fulfilled where it applies, or in families guaranteed to be 100 per cent. non-technical, there are still many situations where a spare set or two, even of inferior characteristics, is useful. Reference to situations suggests that the existence of an independently controlled set in the kitchen places in the mouth of the would-be mistress a most valuable talking point for interviews. Then the diversity of interests within the modern family is notorious. Provided that amicable agreements can be drawn up between the



The smallest set: this Empiric Pocket Receiver is designed for headphone listening.

members of it, including clauses relating to such things as output levels, there is no reason why one cause of open warfare should not be removed by providing separate listening posts for the diverse factions. While this applies more obviously to large families, there are times when a source of dissension between so few as two people might be avoided in this way.

Then there is another common type of home in which the exact nature of the programme fails to arouse such bitter strife simply because nobody listens with sufficient discrimination. It just goes on and on as a background. Owing to the long hours worked, and perhaps the careless or non-existent maintenance, receivers in these circumstances are liable to breakdown. So, for the matter of that, are most other receivers. The moment when such failures occur is not infrequently just before some broadcast that one *must* hear. I don't regard this as due to wilful perversity on the part of

the apparatus, but merely because there are rather more broadcasts of this sort than most people care to admit, at any rate in the hearing of the B.B.C. At such times it is pleasing to be able to fall back on a reserve.

"Diallist" has drawn attention to what might happen in a state of national emergency, whether arising from causes within or without the country. In the General Strike of 1926 the existence of a direct means of communication throughout the country, for the spreading of news, the quelling of rumours, and personal talks by the leaders of the Government, did more than anything else to prevent panic and uncertainty. In 1926 receivers were battery receivers.

"War, Riot, and Civil Commotion"

If something happened to cut off electric power supplies now, communication by broadcasting would largely cease just when it would be most needed. One supposes that in the event of an air raid the key power stations and other conspicuous features of the Grid would not be last to receive the attention of the invaders. The B.B.C. has gone to great trouble to render itself independent of external sources of power, but very few listeners have followed their example.

Why does not the radio trade make some effort, in these days of talk about licence saturation, to popularise the Second Set habit, including a revival of the humble crystal? It depends on no power supply; not even batteries. The cost is, or could be, trifling. The chief item is a pair of phones.

Incidentally, I wonder how many people, accustomed now to assume a loud speaker as the medium of listening, have considered the claim of phones? My preceding suggestions have tended to assume that more than one room is available for listening to separate programmes.

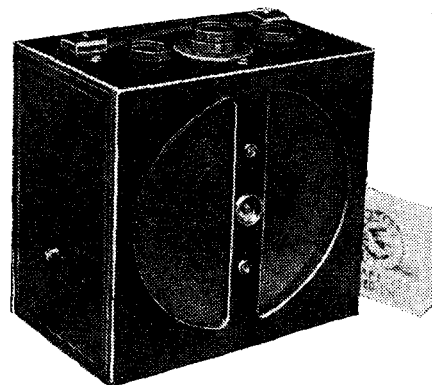

A midget loud-speaker portable (the Wayfarer) compared with a packet of cigarettes.

"Just Think What Two Can Do!"—

not the case, in winter, at any rate, for enthusiasm seldom touches the level of sitting in a cold room. Even when only a single programme is required there are sometimes other occupants of the living-room who prefer silence. It is hardly fair of parents to expect their progeny to do homework (which they themselves would not be prepared to tackle even in the most favourable environment) during the course of a broadcast by Will Hay.

Moreover, even although time has rolled some considerable distance beyond the nineteenth century, the diffusion by loud speaker of certain B.B.C. talks on the relationships between parents and children are liable to cause embarrassment within the radius of audibility. Persons wishing to avail themselves of

such programmes clearly stand to benefit by using phones. And phones serve not only to bring the wanted programme in, but to keep surrounding noises out.

Even apart from crystal sets a receiver for phone working is relatively cheap, compact, and portable. There are distinct signs of a revival in this class of set. J. H. Reyner's recent articles on a pocket receiver have aroused much interest. One or two commercial products point in the same direction. Compared with the days of the earlier portable set boom everything is in favour now. Transmitters are more powerful; efficient midget valves are available; so are special dry batteries and accumulators, and compact but efficient iron-cored coils.

Finally (in case you are wondering) I am *not* financially interested in any of this.

"SIMPLAT" SOUND-RECORDING DISCS

IN appearance these discs are very similar to ordinary records. They make use of a glass base which is coated with a black substance to a uniform depth. After cutting (for which a special sapphire needle is provided), the surface is hardened and polished by special fluids and is ready for replaying in about ten minutes.

Ordinary needles may be used if the pick-up is of the piezo-electric type. The record seems to take and hold sounds involving transients and sudden attack very well indeed, and surface noise is negligible. The groove under the microscope has a remarkably clean and uniform appearance.

The records are available in diameters from 7in. to 16in., and are obtainable from the V.G. Manufacturing Co., Ltd., Gorst Road, Park Royal, London, N.W.10.

Recent Inventions

The following abstracts are prepared, with the permission of the Controller of H.M. Stationery Office, from Specifications obtainable at the Patent Office, 25, Southampton Buildings, London, W.C.2, price 1/- each

CRYSTAL-CONTROLLED OSCILLATORS

IN order to reduce the effect of inherent valve capacity the control crystal is so coupled to the oscillatory circuit that an increase of damping is accompanied by an increase in effective reaction. As shown in the Figure one electrode of the crystal is connected to the cathode of the valve *V* through an impedance *Z*₁, in

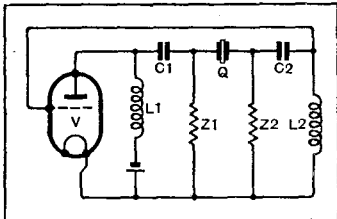

Reducing effect of valve capacity.

parallel with a capacity *C*₁ and coil *L*₁. The other side of the crystal is similarly connected to the cathode through an impedance *Z*₂ and a parallel path comprising a condenser *C*₂ and coil *L*₂. The high-tension supply is taken through the coil *L*₁. The back-coupling to the grid is taken from the upper end of the coil *L*₂.

Patent issued to K. Heegner. Convention date (Germany) 4th January, 1933, No. 431068.

AUTOMATIC VOLUME CONTROL

IN the arrangement shown, radio or intermediate-frequency signals applied to the input circuit *L* are amplified by the valve *V* and pass via the transformer *T* to a tuned circuit *T*₁, feeding a diode rectifier *D*. The resulting voltage on the load resistance *R* applies a primary AVC to the grid of the amplifier *V*, which is only effective when the signal strength reaches a pre-determined level, since the fixed voltage from a resistance *R*₁ creates a delay bias. An increase in signal strength reduces the potential of the point *X*,

Brief descriptions of the more interesting radio devices and improvements issued as patents will be included in this section

and also the potential of the cathode of the amplifier *V*. This brings into action the right-hand anode of the diode *D*, which is connected to the resistance *R*₂, and so applies an additional or secondary AVC on the grid of a preceding amplifier (not shown).

Patent issued to E. K. Cole, Ltd., and A. W. Martin. Application date 21st October, 1933, No. 430743.

"FILM" TELEVISION

IN transmitting a programme from a kinema film, the necessary synchronising-signals are derived from an obturator or apertured band, which is separate from the scanning-device proper. Preferably opaque strips or spots on the film are used; or the edge of the film may be impressed with a wave-form, corresponding to the required saw-toothed impulses, in addition to the usual sound-track. The synchronising-impulses may be radiated on a separate channel, or

superposed in suitable phase relation on the picture signals.

Patent issued to J. C. Wilson and Baird Television, Ltd. Application date 3rd January, 1934, No. 431340.

o o o o

ADJUSTABLE VALVES

THE frequency of the waves generated by a valve used in the Barkhausen-Kurz manner is determined almost wholly by the spacing or geometry of the electrode system, and only to a small extent by external tuning. In order, therefore, to use the same valve for generating different wavelengths in the decimetre range, a provision is made for deforming or adjusting one of the electrodes from outside the glass bulb.

For instance, the spiral wire of the grid may be extended or compressed by means of a glass rod, forming a kind of "bellows" mounting. One end of the rod extends outside the bulb, whilst the inside end engages a hooked

extension of the wire grid; or the required movement may be obtained by magnetic or thermal control. In the same way the anode may be slotted, and the width of the slots varied by external means.

Patent issued to Telefunken Ges fur drahtlose Telegraphie m.b.h. Convention date (Germany) 6th February, 1933, No. 431716.

TELEVISION

RELATES to a system of television in which pictures from a kinema film are projected on to the sensitised electrode of a cathode ray tube of the mosaic-cell type, and are then scanned by the electron stream passing through the tube. In such arrangements the film is fed through the gate of the projector intermittently, as in ordinary optical projection, and not continuously, as is usual in disc-scanning systems of a similar kind. The drawback of the intermittent feed is that there is a loss of approximately 25 per cent. of the total scanning time. Attempts to speed up the intermittent period are found to be impracticable.

According to the invention the film is fed through the gate at normal speed, and a shutter is used to flash the picture on the mosaic-cell electrode during the time the film is stationary, say, for a period of about 10 per cent. of the full cycle. During this time the cathode ray is cut off, so as to permit a full development of the static charges produced by the action of the light on the sensitive cells. For the rest of the cycle the shutter blocks out the light, and the scanning-ray is brought into action. This allows a brilliant picture to be built up, and, incidentally, reduces the width of the frequency band required for the transmission of a picture possessing a given degree of detail.

Patent issued to Marconi's Wireless Telegraph Co., Ltd. Convention date (U.S.A.) 3rd January, 1933, No. 431258.

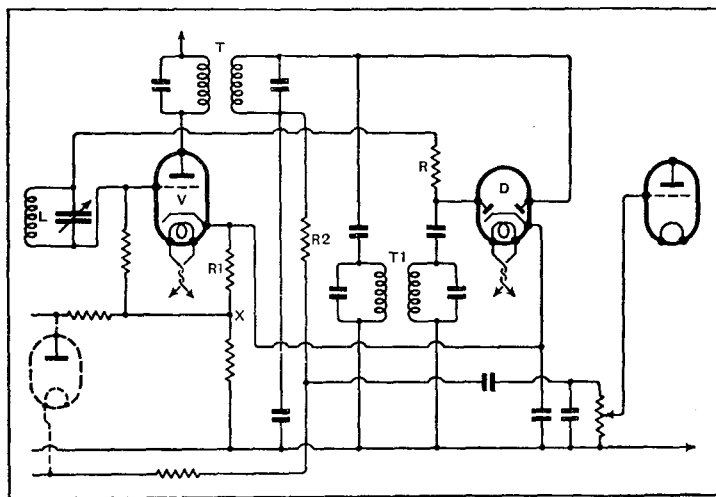

An arrangement to provide secondary AVC.

The Wireless World

THE PRACTICAL RADIO JOURNAL
25th Year of Publication

No. 851.

FRIDAY, DECEMBER 20TH, 1935.

VOL. XXXVII.

No. 25.

Proprietors : ILIFFE & SONS LTD.

Editor :
HUGH S. POCOCK.

Editorial,
Advertising and Publishing Offices :
DORSET HOUSE, STAMFORD STREET,
LONDON, S.E.1.

Telephone: Waterloo 3333 (50 lines).
Telegrams: "Ethaworld, Sedist, London."

COVENTRY: Hertford Street.

Telegrams: "Autocar, Coventry." Telephone: 5210 Coventry.

BIRMINGHAM:

Guildhall Buildings, Navigation Street, 2.
Telegrams: "Autopress, Birmingham." Telephone: 2971 Midland (4 lines).

MANCHESTER: 260, Deansgate, 3.

Telegrams: "Iliffe, Manchester." Telephone: Blackfriars 4412 (4 lines).

GLASGOW: 26B, Renfield Street, C.2.

Telegrams: "Iliffe, Glasgow." Telephone: Central 4857.

PUBLISHED WEEKLY. ENTERED AS SECOND CLASS MATTER AT NEW YORK, N.Y.

Subscription Rates:

Home, £1 1s. 8d.; Canada, £1 1s. 8d.; other countries, £1 3s. 10d. per annum.

As many of the circuits and apparatus described in these pages are covered by patents, readers are advised, before making use of them, to satisfy themselves that they would not be infringing patents.

CONTENTS

	Page
Editorial Comment	631
Resistance and Capacity Bridge ..	632
The Radio Industry Forges Ahead	636
Unbiased	638
Current Topics	639
Scott Hi-Fidelity All-Wave Superhel	640
Choke Input Filters I	644
Listeners' Guide for the Week ..	646
Letters to the Editor	648
Hayberd 4-point Receiver ..	649
Broadcast Brevities	651
Random Radiations	652
Readers' Problems	653
Recent Inventions	654

Editorial Comment

Television Public Misunderstandings

WHEN television starts, sets for reception will be a luxury commodity. Although we may look forward to a gradual cheapening over an extended period of time, we must face the fact that at the outset there is unlikely to be any receiver available at a price below fifty pounds. Fortunately, this does not mean that those who cannot afford to own a set will not be able to know something of what is going on, for, as we have constantly urged, it has been decided that receivers will be installed at a number of places in London where the public will be able to "look in."

It is common knowledge that talk about television has had the effect of discouraging people from replacing their existing wireless receivers, apparently for the reason that they imagine, with the arrival of television, sets which they might buy now would become obsolete.

We think that readers of *The Wireless World*, coming in contact as they do with so many who are not knowledgeable on the subject of wireless and who appeal to them for advice, should make a special point of making the position clear to them that there is really no connection between a television set and an ordinary broadcast receiver. The two will be almost as distinct entities in the home as the electric vacuum cleaner and the refrigerator. There will be no change in the design of future broadcast receivers resulting from the introduction of television, nor will the television receivers be designed to receive ordinary broadcasting. To attempt to combine the two would only complicate and add to the cost of both, and even to have the two in the same cabinet will probably prove to be undesirable on technical grounds.

The sound accompanying vision will be on an adjacent wavelength to the vision and will therefore not be heard on the ordinary broadcast set. Those who may like to experiment with listening to these sound transmissions alone will require a simple short wave set for the purpose and would not want it combined with the broadcast receiver.

To most of our readers it may seem unnecessary to mention these points, but when it is daily brought home to us how ill-informed the general public is on the question, we feel that there is every excuse for asking our readers to do what they can to guide the general public to a better understanding of the actual position before the television transmissions begin.

Extension Loud Speakers

B.B.C. Retarding Popularity

DURING the past year there has been a great increase in the demand for extension loud speakers for fitting in various rooms and controlled centrally from the set. Now there is evidence of disappointment, not on the score of the efficiency and convenience of the arrangement, but because, thanks to the persistent disregard by the B.B.C. of the question of wide variations in output, it is impossible to set the volume control at the receiver in advance and then listen in another room with an extension speaker. During one item you strain to hear and at the next you are nearly blown out of your chair. When will the B.B.C. wake up and find a remedy for this exasperating state of affairs?

Resistance and Capacity Bridge

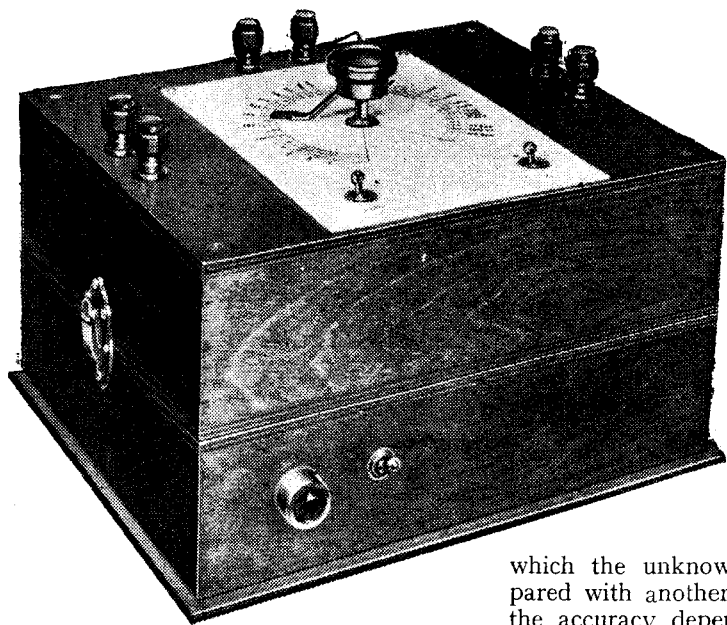

A "WIRELESS WORLD" WIDE-RANGE TESTING SET

THE measurement of resistance and capacity is a matter of considerable difficulty unless proper apparatus is available, and this is usually cumbersome and expensive. A bridge is described in this article, however, which enables measurements to be made over a wide range with an accuracy adequate for all practical requirements, and which is, moreover, extremely simple to construct.

AMONG the components used in the modern receiver, resistances and condensers predominate in number. In many cases quite large variations from rated values do not greatly affect the performance, but there are times when a component must be fairly close to its rated capacity or resistance if good results are to be secured. A simple method of measuring the values of components is consequently of great value not only when building a new set but when endeavouring to locate the cause of a breakdown in an old one.

It is not difficult to check resistances, and the ohmmeter affords one of the simplest methods. The ohmmeter, however, while indispensable for many purposes, is usually accurate only over a comparatively small range of resistance values. To give a good indication over the wide range of values encountered in wireless practice, several ranges are needed with different battery voltages for each range. This is not a very serious drawback, but the fact remains that the ohmmeter is not the best method of measuring resistance, although it will undoubtedly remain one of the most convenient ways of checking the values of resistances which are actually connected in a receiver.

The measurement of capacity is much more difficult. It is, of course, possible to devise an instrument on the lines of the ohmmeter, but using an AC meter and the AC mains as a source of voltage. In practice such an instrument can give reasonably good results only for large capacities, and is apt to fail when applied to condensers of less than about 0.1 mfd. Furthermore, it has the grave disadvantage that it can be used only when a source of AC is available.

There is no doubt that the best method of measuring capacity is by means of a bridge. This is a comparison method by

which the unknown condenser is compared with another of known value, and the accuracy depends upon how closely the relative values of the two can be determined and upon how accurately the capacity of the standard is known. The basic circuit is shown in Fig. 1, and it is easy to see that if the reactances of C_1 and C_2 are the same and R_1 equals R_2 there will be no current through the telephones. If R_1 does not equal R_2 , however, there will be a difference of potential between the two sides of the phones and, consequently, an audible note in them. As the slider of the potentiometer is moved, therefore, the

different. The balance point is connected with the relative values of the condensers by a very simple relation: $R_1 : 1/\omega C_2 :: R_2 : 1/\omega C_1$. Consequently $R_1/R_2 = C_1/C_2$. If one of the condensers, say C_2 , has an accurately known value, and the resistances can be accurately measured each time a balance has been obtained, the unknown capacity is readily calculated and is $C_1 = R_1 C_2/R_2$. This is naturally inconvenient for general use, but it is easily possible to provide a scale giving a direct calibration in capacity, and the

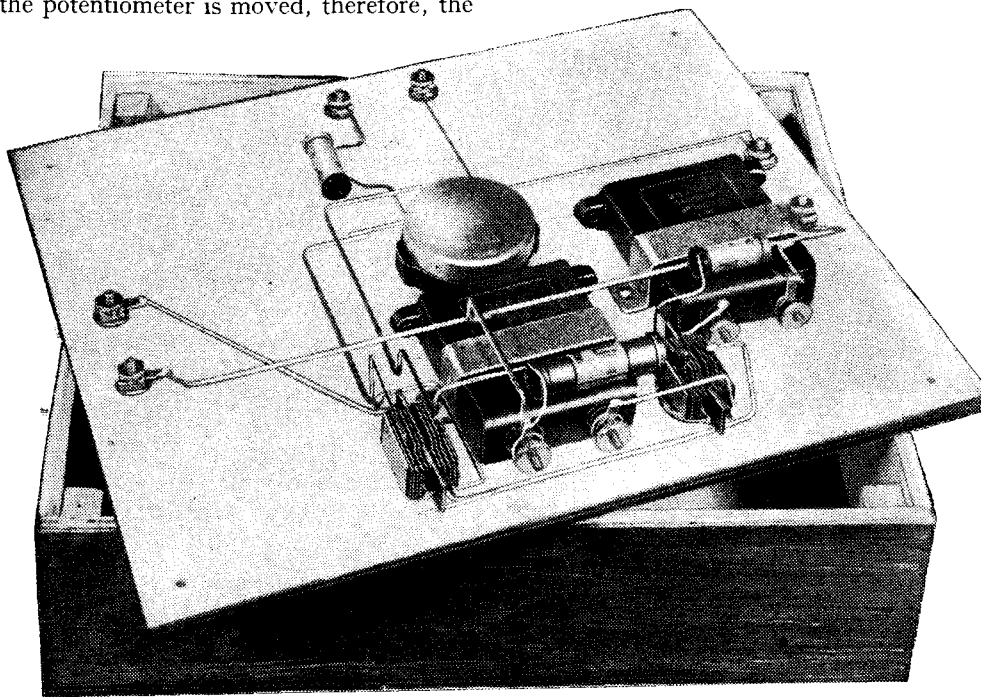

An under view of the bridge. All components are mounted on the panel which forms the lid of the box.

strength of the sound in the phones will vary and at the exact balance point when R_1 equals R_2 will disappear.

It is not, of course, necessary for the two capacities to be equal, but if they are not equal the balance point will be

operation of measuring capacity then becomes no more than connecting the condenser to the terminals, adjusting the control knob to give the balance, and reading off the capacity directly from the scale.

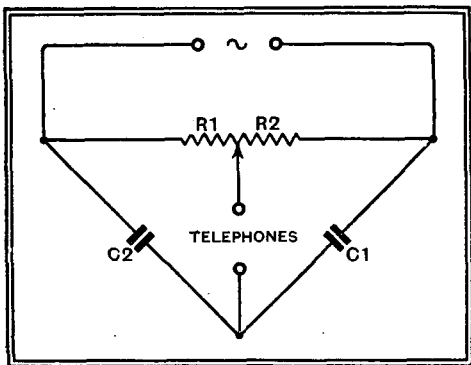

Fig. 1.—The basic circuit of a capacity bridge.

In theory it is possible to measure all capacities from zero to infinity in a single range, but this is hardly possible in practice with ordinary potentiometers, for the scale would become extremely cramped at the ends. With only two ranges, however, it is easy to measure any capacity between 10 mmfds. and 10 mfd.

The same bridge may be used also for the measurement of resistance if the standard condenser be replaced by a standard resistance, and if the values be suitably chosen the same scale and calibration hold for both resistance and capacity measurement. This has been done in the bridge described in this article, and two ranges are provided. On one range resistances of 10 ohms to 100,000 ohms can be measured, and capacities of 10 mmfds. to 100,000 mmfds. (0.1 mfd.), while on the other scale the reading is multiplied by 100 and so gives a range of 1,000 ohms to 10,000,000 ohms (10 MΩ) or 1,000 mmfds. (0.001 mfd.) to 10,000,000 mfd. (10 mfd.).

The complete circuit diagram of the bridge is shown in Fig. 2, and it will be seen that the control consists of a 20,000 ohms potentiometer R5. The switch S3

changes over the connections for capacity or resistance measurements, and the switch S2 changes the range. There are two resistance standards, R3 and R4, of 1,000 ohms and 100,000 ohms respectively, and two capacity standards, C4 and C3, of 0.001 mfd. and 0.1 mfd. respectively. The values of these components must be accurately known, and if the bridge is to have any pretensions to accuracy and reliability good quality components having values within ± 1 per cent. of their ratings must be used.

The total value of the balancing potentiometer R5 has no effect on the accuracy, and it is only necessary that the ratio of the two halves be the same in different potentiometers for all positions of the

the inevitable price which must be paid for avoiding the trouble of calibration.

Constructionally, the components are all secured to a wooden panel which forms the lid of a shallow box, and to which the scale printed in this issue on page 652 may be pasted. The only non-standard part employed is the pointer, which is best cut from a strip of brass and screwed to the control knob by two 8BA screws. Holes must be drilled and tapped in the knob to receive these screws, and some care is needed in carrying out this operation, for the bakelite is apt to crumble somewhat.

Energising the Bridge

A source of alternating current is necessary to energise the bridge. AC mains are not suitable, and the simplest arrangement is to use a buzzer, connecting the input terminals of the bridge across the coil of the buzzer.

The writer must confess, however, to a dislike of buzzers on account of their unreliability and their mechanical noise. Cheap buzzers are very troublesome, being difficult to start buzzing properly and liable at any moment to cease work. Good

reliable buzzers usually cost as much as a valve oscillator and suffer from the disadvantage that the direct noise often renders it difficult to distinguish the exact balance point in the phones.

In the writer's experience a valve oscillator is the best, since it is both reliable and silent, and it is not unduly expensive. The circuit of a suitable oscillator is given in Fig. 3, and it is recommended that it be built as a separate unit so that it is available for other purposes, such as energising a bridge of different type, testing LF amplifiers, and modulating an HF oscillator. A single valve

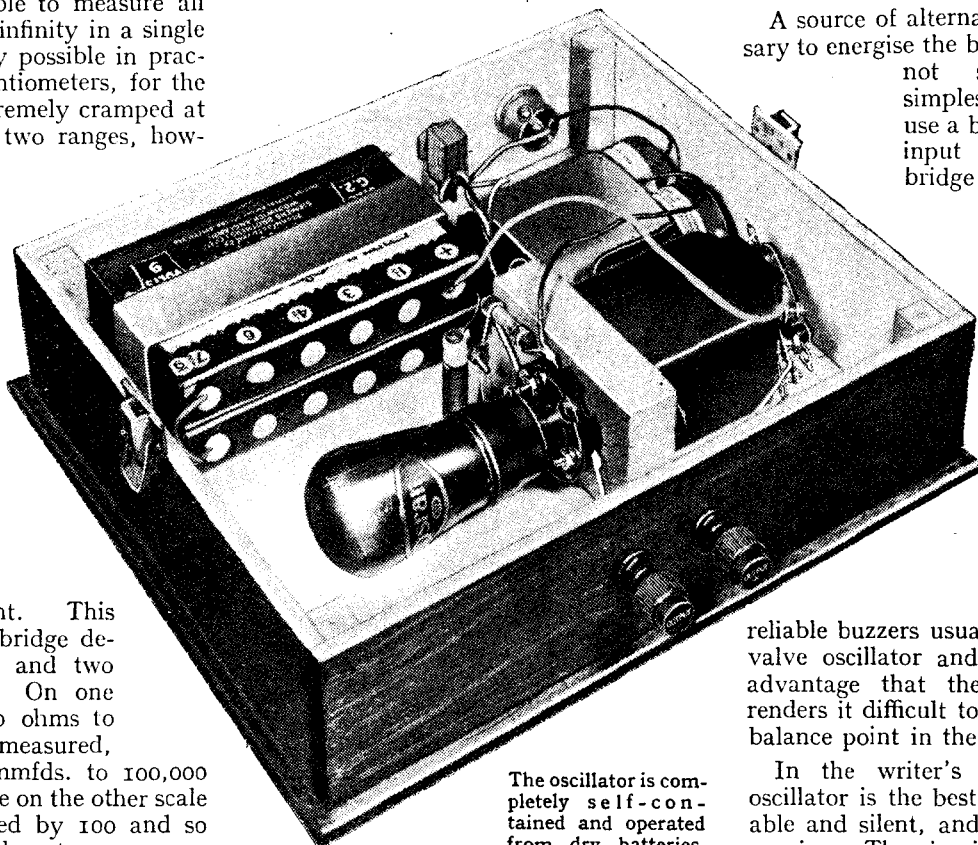

The oscillator is completely self-contained and operated from dry batteries.

slider in order to permit a printed scale to be used. This requirement is met quite well when a uniformly wire-wound potentiometer is used, and although the accuracy may suffer slightly through the absence of individual calibration, this is

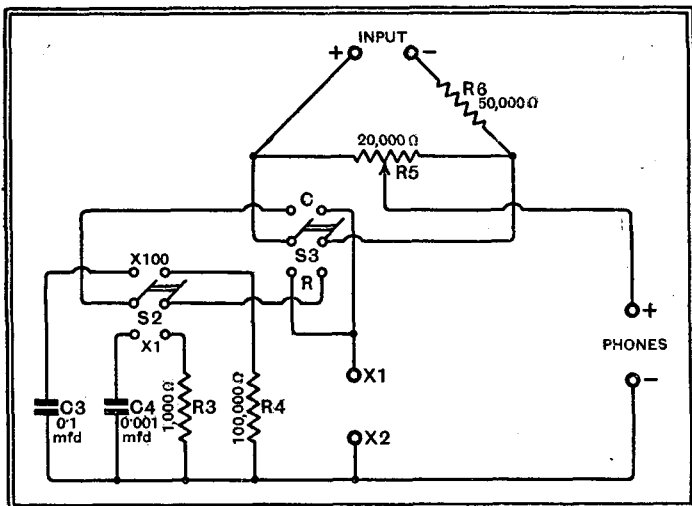

Fig. 2.—(Left) The complete circuit diagram of the bridge showing the switching arrangements

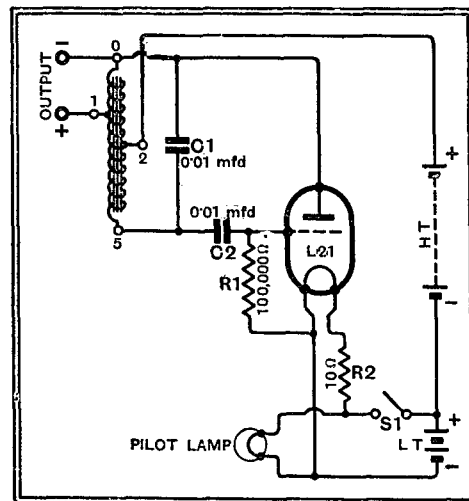

Fig. 3.—(Right) The oscillator is of simple type and economical in operation

Resistance and Capacity Bridge—

is used as a Hartley oscillator with a 3H choke tuned by a 0.01 mfd. condenser C1. Two dry cells are provided for LT and operate the valve through a 10-ohms resistance R2. With new batteries the voltage on the valve does not exceed 2.2 volts, which is no more than could be obtained with a freshly charged accumulator

applied directly to the filament. Experiment has shown that the valve will continue to oscillate until the filament potential falls to about 1.5 volts, so that there is a wide latitude for falling battery voltage, and an adjustable resistance is unnecessary. The HT supply is provided by two 9-volt batteries, and as negative HT is connected to positive LT,

the filament battery is effective in increasing the HT supply. With new batteries rather more than 21 volts HT is available, and oscillation continues until the HT falls below some 15 volts, so that here, also, ample allowance has been made for falling battery voltage. An on-off switch has been provided, and a pilot lamp to give warning that the oscillator is

DIMENSIONS, LAYOUT AND WIRING

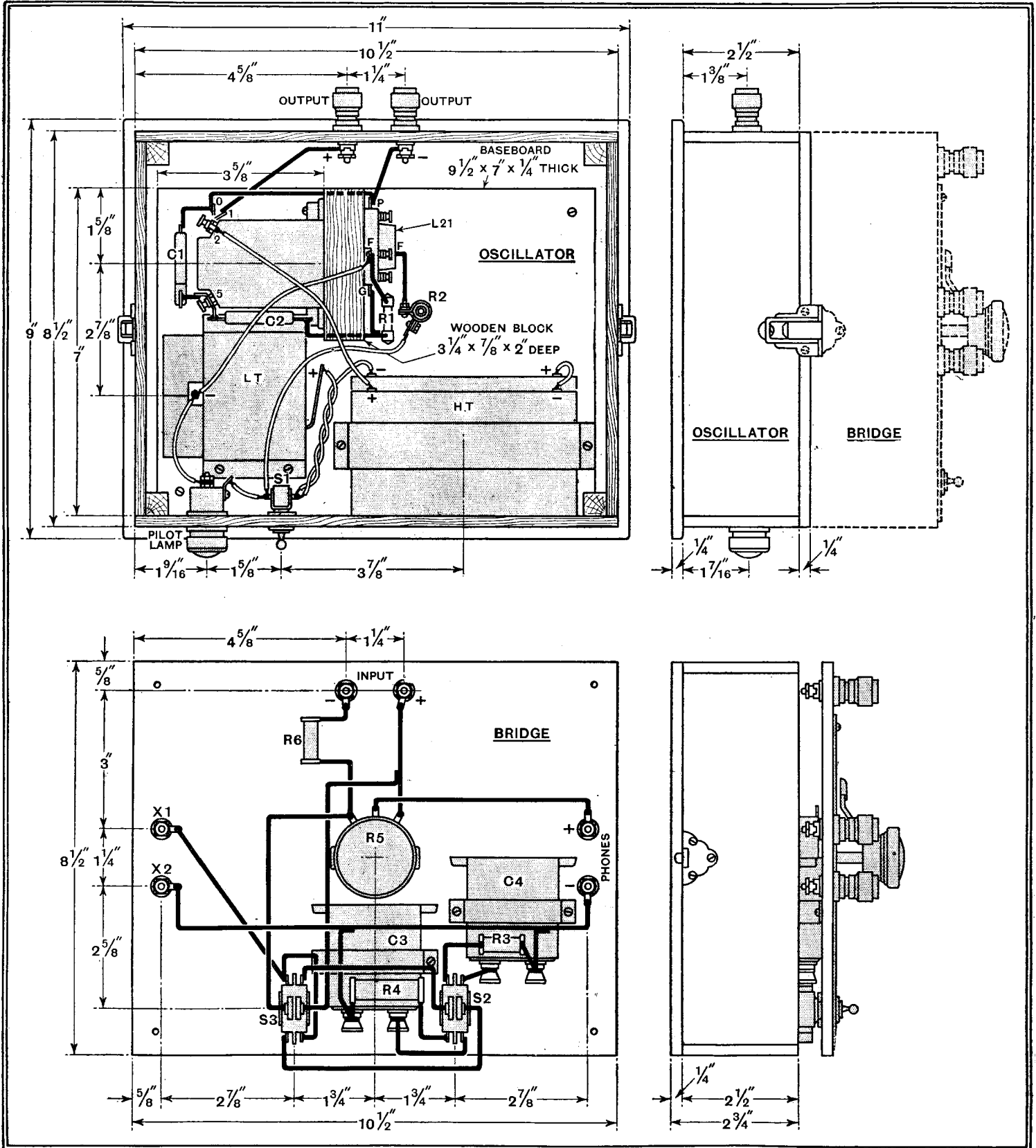

Full constructional details of both bridge and oscillator are given in these drawings.

Resistance and Capacity Bridge—

on and so remind one to switch it off when it is no longer being used.

In order to reduce the load of the bridge on the oscillator and prevent wide variations in frequency and amplitude with different capacities, a 50,000-ohms resistance, R6, is joined in one of the bridge input leads. If a buzzer be used for energising the bridge it may prove necessary to short-circuit this resistance. A pair of high-resistance phones must be used, and with nothing connected to the "X" terminals the oscillator note should be quite loud. The condenser or resistance to be measured should be connected to the "X" terminals and the switch set appropriately to "C" or "R." In most cases the value will be approximately known and the range switch can then be set appropriately. The balance point will be found to be quite definite, although complete extinction of the note may not always be obtained. The minimum, however, is so definite that it cannot be mistaken; it is not obscured by oscillator harmonics.

The reason why a null-point is not always obtained is that no provision is made for balancing out the effect of any resistance in the condenser being tested nor for balancing out the effect of capacity in the resistance being measured. Normally, these effects are small with good components, and the extra complication to the bridge and its operation is not worth while. If it be found, therefore, that with a particular component a bad balance is secured, it is possible that, if a condenser, it has a bad power factor, or if a resistance, it has a high self-capacity.

It must be remembered that the reading of capacity obtained includes the self-capacity of the bridge and connecting leads. This can readily be determined by balancing the bridge or capacity with nothing connected to the "X" terminals, and was about 30 mmfds. for the original instrument. In order to obtain the true capacity of a condenser, therefore, this

figure must be deducted from the reading obtained. This correction is unimportant for capacities higher than 1,000 mmfds.

Even when no attempt at individual calibration is made, and the printed scale is used, care must be taken to set the pointer correctly. This may, of course, be done by the end marks which indicate the limits of travel of the pointer, but for the greatest accuracy it would be wise to obtain a 1,000 ohms resistance within ± 1 per cent. (such resistances are not expensive) and to balance the bridge with this resistance connected to the "X" terminals. Leaving the bridge balanced, set the pointer to read exactly 1,000.

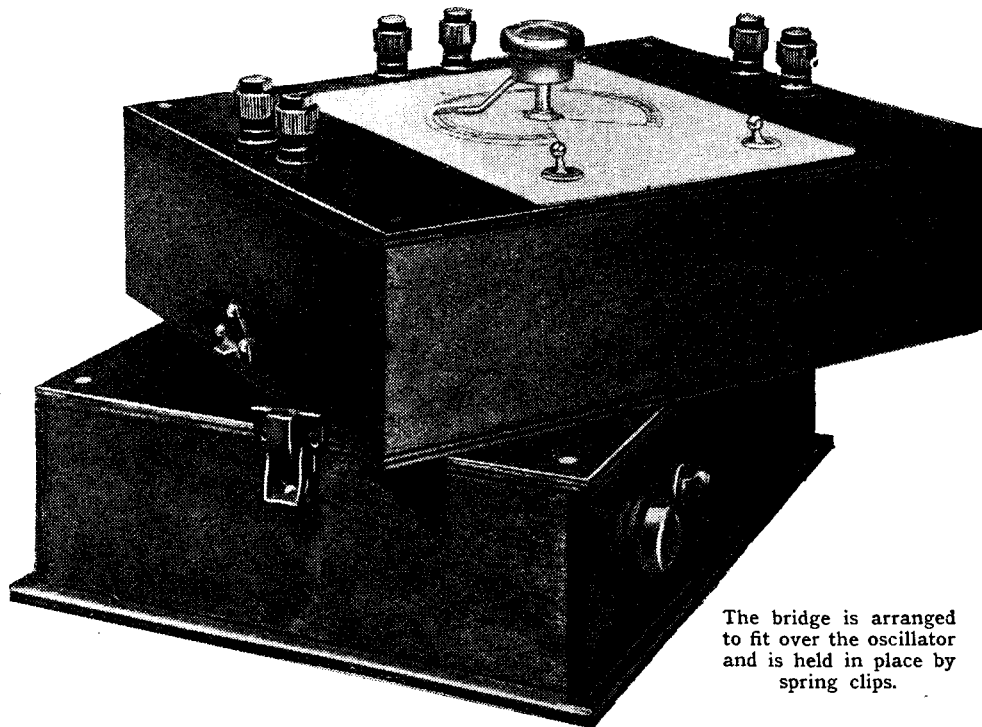

The bridge is arranged to fit over the oscillator and is held in place by spring clips.

It may be remarked that no earth connection must be used on any point of the bridge or oscillator. The condenser or resistance under test must be disconnected from other gear, otherwise appreciable errors may be introduced.

Luxembourg and Fécamp, but that, in many instances, just about completes the list. Sometimes in turning from their own National to its twin Regional they stumble across a station which is coming in so well that they listen to it for a time; but as often as not they have no idea what it is, and since they fail to make a note of the dial setting, they don't turn to it again—except by accident—on another evening.

I am sure that if any reader makes investigations when visiting the homes of non-technical friends he will find very much the state of affairs that I have described. The repertoire may be slightly larger, but very seldom will it include more than half a dozen foreign stations that are known and regularly used.

If you care to spend an hour or two in showing friends of this kind just what are the possibilities of the up-to-date receiving set you will find that your demonstration comes as a revelation and that it is very warmly welcomed. Don't bother about weak and very distant stations, or those whose transmissions are marred by fading or by interference of any kind. Keep strictly to the very best, those, I mean, which come in with almost "local" strength and quality, and don't flit from one to another after just a few bars of music. Tell them the name of each station and note down for them carefully just what they have to do to tune it in when they want it again.

D. EXER.

Distant Reception Notes

A RECENT report by the Russian broadcasting authorities states that that country has now sixty-six broadcasting stations in full operation. Going carefully through the official lists I can find only twenty-seven Russian stations mentioned; I suppose that the other thirty-nine are stations situated between the Ural mountains and the Far East.

A fortnight ago I referred to the report that Russia was contemplating the erection of a 2,500 kilowatt station. I mentioned then that it seemed more likely that her intention was to link up stations with a total rating of 2,500 kilowatts for the transmission of special programmes. A further letter from a kind Continental correspondent gives the information that, though the 2,500 kilowatt link-up is probably at the bottom of the rumour that was in the air, it is believed that Russia is considering the possibility of building a long-wave trans-

mitter a good deal more powerful than anything that she possesses at present.

With the sole exception of Greece, which does not possess a single broadcasting station (or, at any rate, one in operation), Bulgaria is at present about the worst served country in Europe from the wireless point of view. Her only station is at Sofia, and as the plant is rated at one kilowatt and the wavelength of 352.9 metres is shared with four other stations, reception can't be too good. Bulgaria is a pretty big country, almost rectangular in shape and measuring roughly 250 miles from East to West and 150 from North to South. The main ridge of the Balkan mountains, running from East to West, divides the country almost into two, and Sofia stands right amongst the mountains some forty miles only from the western frontier. It would therefore be no easy business to cover the whole land even with a high-powered

The Radio Industry Forges Ahead

"... radio
in its
infancy ..."



Methods of Design and Manufacture Described

THE most remarkable thing about radio engineering is its progress. Some of us still remember those far-off days when radio was in its infancy (it must be every bit of three years ago), when manufacturers never thought of actually designing their sets before the opening of the Show at Olympia—it would have been taking a fearful risk of finding all their carefully laid plans completely set aside by the appearance of a last-minute sensation in the form of a rival set making everything else two (or possibly three; one never really knew) years obsolete.

The policy was to concentrate on some really tip-top cabinets, and perhaps a few surplus experimental chassis chromium-plated so dazzlingly as to baffle itinerant students of technique. Underneath the dust-covers that greeted the earlier arrivals on opening day, and while attention was being distracted by the inaugural speech of Lord Biggensides, high-pressure poster artists were busy on display matter featuring selling points judged to be up, but not too much up, on what a discreet nosing around had revealed on other stands.

The deterrent from claiming too much was partly that it would make it more difficult to think of plausible new inventions next season, but chiefly that having announced these exclusive features it was the duty of the technical department to produce them as quickly as possible—preferably before the end of the Show. On having the news broken to them the technical people retired with ill-smothered imprecations to what amounted to a term of solitary

"... a discreet
nosing
around ..."

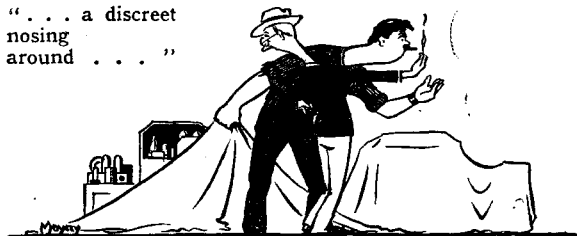

confinement, with hard labour. Bidding their wives and sweethearts goodbye (this was sometimes allowed by the more enlightened managements) they sent for stores of stimulants, according to requirements; a quiverful of 20in. slide rules; and the last few months' issues of *The Wireless World*, and got busy.

Needless to say, the Show was over before they had got much farther than finding that none of their ideas was feasible, owing to failure to make use of stocks of old materials; and the technical representatives on the stand, recruited from a male-chorus agency, accordingly had an uphill fight with importunate enquirers.

It is to be regretted that readers of *The Wireless World* have been among those who have openly confessed to the baiting of these unfortunate gentlemen. This is quite inexcusable in view of the fact that all the information extant, being arranged on show-cards facing outwards from the stand, could be much more conveniently read by the enquirers than by the staff within.

In spite of this lack of co-operation by a section of the public, it was usually found quite practicable to hold off customers until after Christmas, either by reports of unprecedented demands on the factory, or by issuing a succession of dummy models; but early in the New Year most firms were beginning to release working sets. Owing to the rich imagination co-existing with sales and publicity staff, the specifications of these sets perforce fell considerably short of that claimed at Olympia. At such a late date it was, of course, a perfectly easy matter for a sales-

man worth his salt to capitalise these discrepancies by pointing out that their ever-progressive research department had made enormous strides in the meantime, and the Show models were completely obsolete.

After a few seasons of this it occurred to the more thoughtful manufacturers that by delaying production just a little more, and fixing the Show a bit earlier—say, August—the two could be made to meet. In the meantime, by selling last year's sets all the season, this year's would be ready for next year.

This has proved of incalculable benefit to the public, who are

"Lack of
co-operation ..."

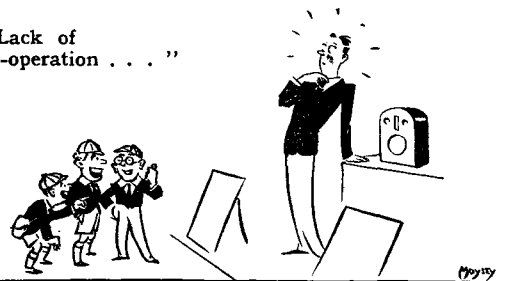

now able to buy an up-to-date wireless set at almost any time they like. The difficulties of the unfortunate manufacturer, however, are still by no means at an end, and some idea of them can be estimated from the following typical case.

A retailer in Giggleswick reports to the Sales Representative for West Yorkshire of Messrs. Sublime, Ltd., that their models are now to the Blarstco, which were champion set—he had sold two of them in the last few months, and if it weren't for them, and the trade in cattle cake, he'd have been nowhere.

Sales Representative for West Yorkshire reports to the Sales Manager of Messrs. Sublime that the Blarstco is selling in thousands all over his area, and can't he send him something that's competitive.

Sales Manager reports to Managing Director that the Blarstco set (made by the Blarstco Co., of Glasgow, you know) is sweeping the market, and he must have a really super model at the right price.

As there are still 15,473 old Sublimes in stock, Managing Director tells Sales Manager to get out a national advertising campaign featuring colossal success of Sublime Radio. Suggests

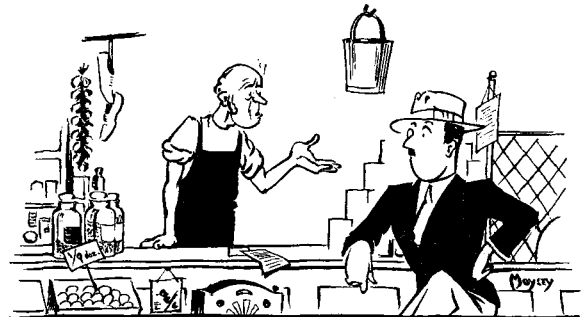

"A retailer in Giggleswick ..."

slogan "SUBLIME RADIO is the BEST." Sales Manager agrees, and later sends for modern psychological advertising agent.

Managing Director sends for Chief Engineer and informs him that sales have gone to the realm of lost souls, and he must have

The Radio Industry Forges Ahead—

something to beat the market. Suggests he cuts out some of the more expensive components from the Sublime AC Five, improves the performance all round, and adds short waves. Is disappointed by lack of enthusiasm with which Chief Engineer greets his brilliant conception of a real winner. Silences him by pointing out that he is a clever fellow who will soon solve any minor problems that may arise out of the details, and that when he has finished it he can take a week-end's holiday.

Murmuring gratefully, Chief Engineer retires to laboratory and rakes out all-wave design that the factory had no time for at the start of the season. Works all night clearing short-wave dead spots. New press-tools for multi-contact switches put in



"Suggests slogan"

hand, after vigorous protest from Works Manager that there are 10,000 old switches in stores.

Sales Manager walks in to see how things are getting on, and reports that short waves are a washout, but he must have barometer tuning. Switch tools are scrapped and Drawing Office gets to work on barometer tuning layout incorporating special indicator lamp brought out just then by the Glofast Co.

Managing Director congratulates Chief Engineer on making such rapid progress, and regrets he forgot to mention that AC/DC valves must be used—firm's new policy. Chief Engineer goes through design once more on the basis of Dascheblo "Universal" valves, and suddenly realises that pick-up sockets will be live. Decides to omit pick-up connections. Spends another night getting the oscillator coils right for the Dascheblo tri-pentode-hexode.

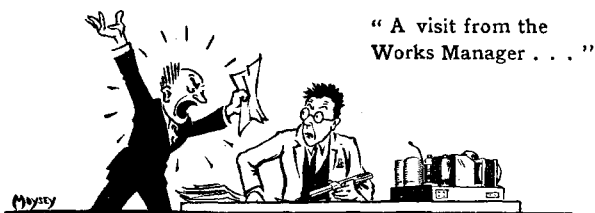

"A visit from the Works Manager . . ."

Somebody discovers that permanent magnet speaker necessitated by introduction of AC/DC valves fouls barometer tuning indicator, and if smoothing choke is built into frame big enough to go where power transformer used to be, so as to retain same chassis drilling, there will be no room for barretter. To put things right cabinets should be made larger; but they have already been ordered. On enquiry, cabinet shop reports excellent progress. The whole delivery is made up, ready for polishing.

Chief Engineer in collaboration with Drawing Office juggles with loud speaker and chassis, and gets things right at cost of new set of tuning indicator tools. Letter arrives from Glofast Co. withdrawing indicator lamp in favour of vastly improved type, working on a much better principle, and making use of quite a different and enormously improved mounting.

Dascheblo Valve Co. refuses to give Sublime, Ltd., any more credit. Managing Director sends note to Chief Engineer informing that for reasons of policy Dascheblo valves must in future models not be used. Chief Engineer, after furious rethinking, circulates particulars of modified oscillator coils necessary to work with the Pongo duo-heptode-tetrode. Receives visit from Works Manager, who wants to know the bright idea just when he has put 5,000 coils into stores on the last specification.

Letter from Director in South of France ordering half a dozen of the new sets specially fitted with cocktail bars to be sent to him by next air mail.

Message comes from Wiring and Assembly asking if it is really O.K. for pick-up sockets to be put in without wiring. Chief Engineer, confronted with this, thinks that his instructions to

" . . . confronted with this"

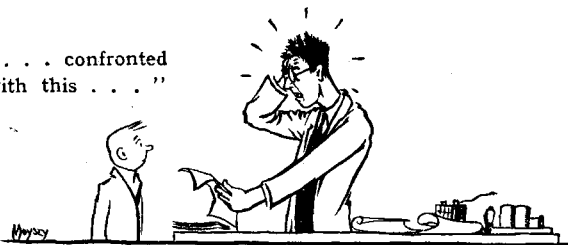

fill up chassis holes with dummy screws must have gone astray. A more awkward one for him is the delivery of 10,000 tuning scales engraved with short wavelengths. Finally he decides to see if the short-wave figures can be hidden by third version of barometer tuning indicator.

Blarstco Co. goes into liquidation.

Sales Manager returns from motoring holiday and reports that "Car radio is here"! After lunch gets Managing Director to instruct Chief Engineer to adapt new design for car radio by connecting valve heaters in parallel instead of series and providing alternative power unit. He emphasises the necessity for working night and day to get a sample out for the Motor Show next week. Chief Engineer gloomily reflects that most of the experi-

" . . . the list of outstanding orders . . ."

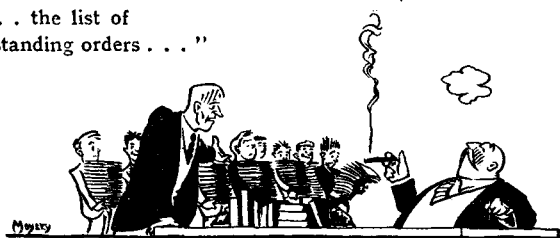

mental constructional staff are already busy on hand-made samples of the new set for Directors' relatives.

Sales Manager returns from the provinces to report that orders for the new set on his description are already colossal. The Works Manager reports that production is now in full swing, and in response to urgent instructions he has the entire factory staff working twenty-four hours per day, and all hands are being compelled to assemble one set with the left hand and simultaneously wire another with the right. Sales Manager considers that this is very unsatisfactory and that there is no hope of overtaking orders unless they work on two sets with each hand, throwing in coil winding with the feet; and demonstrated his point by getting nine office boys to bring in the list of outstanding orders. Managing Director emphasises that the orders there represented are utterly inadequate to show a satisfactory turnover, even if met by production, and will have to be multiplied many times. The Chief Accountant adds that if this were done last season's losses will not be greatly exceeded this year.

" . . . causes heavy casualties . . ."

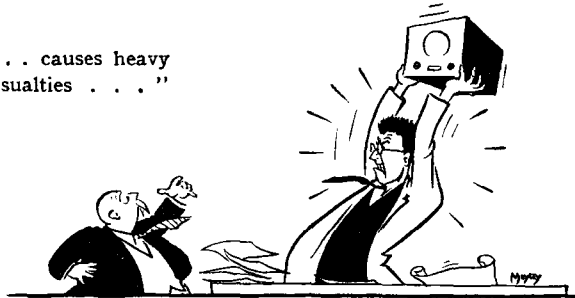

providing that half the employees are discharged to reduce expenses.

Managing Director arrives next morning to report that "Television is here!" and all sets must be adapted for ultra-short waves.

Chief Engineer runs amok and causes heavy casualties before he can be transferred to padded cell.

UNBIASED

By

FREE GRID

There's Many a Slip

I HAVE from time to time been constrained to draw attention to the many historical and other errors which appear in certain B.B.C. programmes, particularly those dealing with past events such, for instance, as the various "Scrap-books" of bygone years.

In the most recent of these, which dealt with 1911, the only thing which I could find wrong was the date of the coronation and the base allegation that it was held on a sunny day. I happened to mention the fact casually to a member of the B.B.C. staff a day or two afterwards, and



Gauge the feelings of all classes.

was interested when he replied that people were getting more knowledgeable concerning matters appertaining to State functions owing to the Jubilee influence.

One thing led to another, as it usually does, and my companion viewed with frank incredulity my statement that I had supposed that these errors in programmes were accidental. They were, he explained, inserted deliberately with a view to "keying" the programme in order to get an idea of its popularity or otherwise, just as the advertisements of patent pills, racing tips, and other commodities and services are "keyed" in the various newspapers by such additions to the address as "desk 67" or "department 49."

It appears that the result of an error is a spate of telephone calls and letters of correction which are dealt with by the special error department which has been established for this purpose. Apparently the reason why such a colossal number of errors appears in certain productions is simply because it is desired to gauge the feelings of all classes of the community, and it is realised that the type of person who can spot an error relating to boxing is not likely to perceive a mistake in the normal procedure at a Mothers' Meeting.

A Modern Reporter

THE old proverb about necessity being the mother of invention was drilled into me from my very earliest days, when I had to rely solely on my own inventive powers to explain my occasional absences from my kindergarten school. Were the youth of this country forced to rely on

their own resources in such matters instead of being petted, pampered and spoon-fed as they are to-day, we should be spared the sorry spectacle of able-bodied married men putting forth the feeble and unoriginal excuse of "being detained at the office" to explain their arrival home just as "rosy-fingered dawn is arising out of the wine-coloured sea," as Homer or Mr. Lloyd George (I forget which) once remarked.

However, I digress. What I wanted to talk to you about was a remarkable instance of the truth of this old proverb which came my way the other day. I happened to be attending a meeting of the local Urban District Council, as a spectator, and after the wild rush for places had subsided, I found that the tidal wave of struggling humanity had washed me up to a place right underneath the platform from which the speakers held us spell-bound by their eloquence. When I had sufficiently recovered my breath to take my bearings I found that I was sitting next to a somnolent individual who was drowsily nodding.

What particularly claimed my attention, however, was a large open suit-case on the floor at his feet, in which I observed a weird-looking apparatus consisting of an amplifier and a slow-moving gramophone turntable, the whole being coupled up by

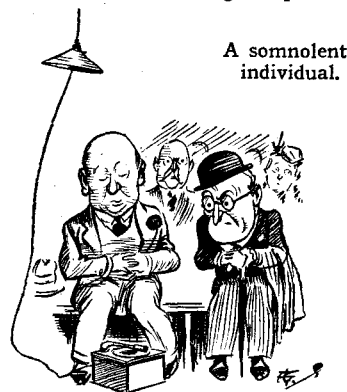

a small microphone which was attached to the lapel of his coat. Needless to say, this instantly aroused my curiosity, and I gave my companion a sharp dig in the ribs. Between the spasms of somnolence which repeatedly overcame him I learned that he was the star reporter of one of our big national "dailies," and that, as a result of long years spent in attending these meetings for professional purposes, he had found himself seized by strange, mysterious attacks of somnolence which had completely baffled medical science.

At length, fearful of losing his job, he had hit upon his present idea of saving his bacon. The apparatus was, of course, nothing more or less than a glorified home recorder, except that one record could

accommodate over four thousand words, or, to put it another way, about twenty-five minutes' worth of eloquence. The whole idea had, he confessed, arisen from an article he had read in *The Wireless World* concerning the new "Talking-Book" record for the blind.

I was naturally anxious to know how he managed to wake up in time to change the record every twenty-five minutes, but this point had not been forgotten. Attached to his wrists by a metal strap were leads from the secondary terminals of an induction coil, which was automatically switched on and so aroused him when the record came to an end.

Warning to Sensitive Lookers

MOST people are aware that in the case of every new broadcasting station that has been opened the B.B.C. engineers have preceded the official test transmissions by several weeks of entirely unofficial ones. Indeed, at various times many of us have got far greater amusement out of these unofficial programmes than from the legitimate ones, the items broadcast ranging from the monotonous repetition of numbers to vocal gymnastics performed by amateur singers among the engineers.

I must confess, however, that I had not the faintest idea that the same sort of thing was likely to take place in connection with television, but as the result of a communication made to me the other evening by a retired employee of the B.B.C., I hastened home to my recently constructed cathode-ray television receiver and after some swift work with the controls was literally staggered by what I saw—so much so that even now I can scarcely believe that the transmission emanated from the Alexandra Palace aerials. A joke's a joke, and I think I may safely say that nobody is more capable of appreciating one than I am, but there are limits, and one must remember that there is always the possibility that women and children might be looking-in.

I am gratified to say, however, that I could recognise none of the prominent and well-known engineers among the faces which flashed up on the screen, and I can only conclude that these impromptu performances are being given by a crowd of irresponsible juniors, and that their superiors know nothing about it. Possibly, of course, the transmissions do not emanate from the B.B.C. at all, but come from across the water. I should like to have the opinions of any of you who may care to look-in during the early morning.

Current Topics

Nearing 7½ Million

MAJOR TRYON, the Postmaster-General, stated in the House of Commons last week that the number of wireless receiving licences in force on November 30th was 7,369,513.

Pronunciation Classes

SPECIAL classes have been opened at Radio-Paris in the pronunciation of foreign names for the benefit of radio announcers and journalists.

It's an Ill Wind . . .

THE accountant at Addis Ababa radio station is the happiest man in Abyssinia, for it is reported that, since the beginning of the war, station receipts are twenty times greater than before the foreign war correspondents began to patronise the service.

Main Sets : 54s.

ALTHOUGH Portugal has no "People's Set" the State broadcasting authority is offering the poorer classes all-electric four-valve sets (make not specified) at about £2 14s. Broadcast announcements of the offer mention that the step has been taken because dealers' charges are too high, thus preventing the peasant class from enjoying radio. No profits are made on the sets, but working expenses are covered.

Non-radiating Trolley Buses

MORE peaceful conditions for those living on trolley bus routes were foreshadowed in a paper read last week at the I.E.E. by Mr. J. Neale, of the G.P.O. Eng. Dept.

Instead of the cumbersome and inexpensive stopper coils formerly fitted to the tops of buses, the latest technique favours local suppression applied to the propulsive and controlling electrical mechanisms. In addition, it has been found that condenser suppressors fixed at intervals along the overhead lines may be more widely spaced than was originally believed. Cost is thus reduced.

Overhead Lines Exonerated

ONE of Mr. Neale's statements regarding bus and tram interference will come as a surprise even to those who, by bitter experience, consider themselves to be *au fait* with the subject. Post Office engineers who have investigated the subject are agreed that most of the interference comes from the electrical gear of the bus itself, and not, as popu-

larly supposed, from the contact between collectors and overhead lines. But the lines do, of course, play a part in disseminating interference.

New N.B.C. Studios

NEW studios are to be opened in Chicago and Hollywood by the American National Broadcasting Company, which will then possess 78 studios, 27 of which are situated in the Radio City, New York.

R.S.G.B. Annual Meeting

A LECTURE on "British Wireless Services of Today" will be an attraction at the annual general meeting of the Radio Society of Great Britain, to be held this evening (December 20th) at the Institution of Electrical Engineers,

He will leave England for the East on his first foreign mission early in the New Year.

French Television Triumph

10,000 PARISIANS attended the opening of the French high-definition television service on December 8th. From 5.30 to 7.30 a varied entertainment of dancing, dramatic scenes, variety sketches and illustrated songs



FRENCH TELEVISION. Artistes of the Comédie Française in a scene before the Paris television transmitter on Dec. 8th, when the high definition service was inaugurated. On the right are the ventilators which counteract the heat set up by the high power arc lights.

W.C.2. It will be delivered by Mr. F. Addey, B.Sc. The business meeting commences at 6.15 p.m.

Mr. F. S. Hayburn

THE many friends of Mr. F. S. Hayburn, managing director of the Marconi International Marine Communication Co., Ltd., will be interested to know that he has been appointed Foreign Envoy to the Marconi group of companies.

was radiated from the studios in the Rue de Grenelle.

Visitors were obviously impressed (writes our Paris correspondent) at the vast improvement in the quality of the pictures following the replacement of the 60-line system with the high-definition process.

On Sunday last a number of television receiving centres were opened in various parts of Paris. The P.M.G. is completing plans for regular transmissions.

News of the Week in Brief Review.

Progress

AN increase in subscriptions by about seventeen per cent. is announced by the Radio Society of Great Britain in their annual balance sheet just issued. Subscriptions at September 30th had totalled £1,964, against £1,679 for the previous year.

Dangerous Question

CONFLICT has arisen between French set manufacturers and the electric supply companies on the question of whether the latter should be permitted to sell radio mains sets.

A scheme is being devised whereby the supply companies canvass wireless orders, which are passed on to the radio trade associations, a reasonable discount being allowed to the supply companies.

Warnings from the Air

VALENTIA transport aircraft now being built by Vickers for service on the North-West Frontier are being fitted with powerful amplifiers and loud speakers so that spoken warning can be given to unruly tribes. Formerly the R.A.F. have warned tribes before offensive action is taken by means of printed leaflets, but in many cases illiteracy has been pleaded. This excuse will be no longer available, nor can deafness be pleaded, for the speakers will be plainly audible a mile away.

Americans Seize Portuguese Market

AN almost entire absence of British sets and radio products was a feature of the Lisbon Radio Show which closed on December 1st. On the thirty-four stands (writes a correspondent) there were sixteen American makes of receiver, seven German, two Dutch, one Austrian, one Swedish and a solitary British set—a Burndept.

It was not possible to test the performance of any set, no soundproof rooms having been provided, but a few sets were "alive"—tuned to the Emissora Nacional, 15 miles away. Portugal has an "American superhet. complex."

Scott Hi-Fidelity All-Wa

FROM the earliest day of broadcasting the Scott organisation has steadfastly pursued the ideal of the perfect receiver, and has produced a long line of models, each an improvement on the last, which have established for this firm a unique reputation in a country which gave birth to, and lives by, mass production. To survive in such an atmosphere the hand-made product must rise to a plane so far above the level of the mass-produced article that comparison is difficult in terms of the established standards of performance. Unfortunately, this costs money, and the price of the latest Scott receiver is £145, excluding cabinet. It is undoubtedly an imposing piece of apparatus, with its forest of valve and coil cans and expanses of chromium plate. But justification for the high cost is not to be found here; for this we must look much deeper, and only those with experience of design and manufacture will fully realise the amount of time and thought which must have been expended in perfecting each detail of the circuit and in blending the various parts into a well-balanced and reliable whole.

The set is described as having twenty-

A Twenty-three Valve Receiver Incorporating Every

FEATURES.—Type.—Superheterodyne receiver for AC mains. **Waveranges.**—**White** 1530-540 kc/s (196-556 metres). **Blue** 370-155 kc/s (810-1940 metres). **Red** 10-4 megacycles (30-75 metres). **Green** 22.6-9.5 megacycles (13.3-31.6 metres). **Circuit.**—HF amplifier—mixer valve—separate oscillator—AVC amplifier (HF)—tuning indicator amplifier—four stages of IF amplification—noise suppressor—beat oscillator—2nd det.—1st LF amplifier—2nd LF amplifier (push pull)—four triode output valves (parallel push-pull). Two full-wave power rectifiers.—Two neon voltage regulators. **Controls.**—(1) Tuning. (2) Volume. (3) Selectivity. (4) Waverange. (5) Sensitivity. (6) Bass Boost. (7) On-off Switch. **Price.**—£145 (chassis, power pack, loud speakers and spare set of valves). **Makers.**—E. H. Scott Radio Laboratories, Inc. **Agents.**—Keates & Co.

three "tubes." These may be divided into two groups, the first of which may be regarded as contributing in some way to the direct handling of the signal through the receiver, and the second as auxiliaries which contribute to the ease of handling and generally add to the refinement of the performance.

The main line through the receiver starts with a signal-frequency HF amplifier and is followed by an electron-coupled mixing valve, no fewer than four stages of IF amplification, a diode second detector, single triode first LF amplifier,

push-pull second LF amplifier, and an output stage comprising four valves in parallel push-pull. Each of the latter valves has two sets of electrodes in parallel so that there are virtually eight valves in the output stage alone.

Among the valves which may be classed as auxiliaries the separate oscillator associated with the frequency changer stage naturally takes first place. Next, there is a separate valve for applying AVC to the signal-frequency HF amplifier. Then there is a valve devoted to noise suppression, another whose sole function is to

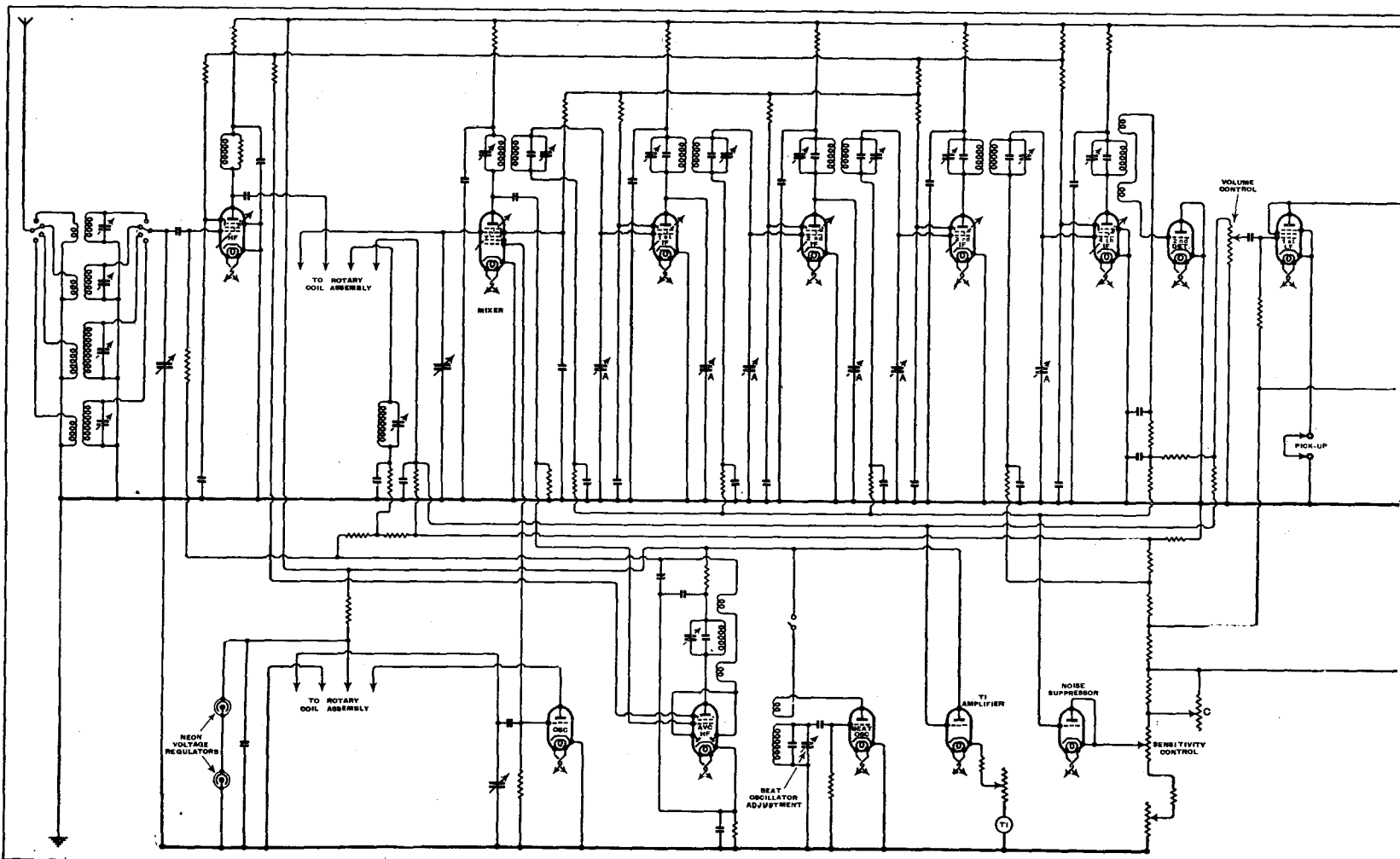

ve Superhet

Conceivable Refinement

act as an amplifier for the meter-type tuning indicator, a beat-frequency oscillator for receiving CW signals, two neon stabilisers for maintaining the anode voltage at the oscillator stage independent of mains fluctuations, and, finally, two power rectifiers.

Waverange Switching

The aerial is coupled to the HF amplifier through a transformer with a tuned secondary circuit. Both primary and secondary coils are switched, and the contacts associated with the secondary winding are arranged to short-circuit the next coil lower in frequency to eliminate dead spots. The amplified signal appears at the anode across an HF choke and is capacity-coupled to a tuned grid circuit in the frequency-changer stage. With the exception of the medium waveband the tuned grid coils are mounted on a rotary coil unit below the chassis. This unit carries also the coils associated with the oscillator

valve. These are brought successively by the wave-range switch to contacts immediately under the valve-holder.

The HT supply to the oscillator valve is shunted by two special neon stabilisers in series. By this means the oscillator anode voltage is maintained constant within $\frac{1}{4}$ volt for changes of mains voltage up to 30 per cent. The output from the oscillator is applied to the first grid of the mixer valve and modulates the amplified HF signal which has been applied to the screened grid. The resulting intermediate frequency is 465 kc/s, and is passed to the IF amplifier. The first three stages in this amplifier make use of valves of the high-impedance high-amplification type which are coupled by transformers with weak magnetic coupling and electrostatic screens between primary and secondary. The fourth valve in the IF amplifier is of a different type with greater power-handling capacity and a tightly coupled transformer which transfers the output to a diode second detector.

Six of the tuned circuits associated with the IF amplifier have additional tuning condensers operated by the variable selectivity control. These work in opposite directions and so increase the band width of the IF filters. The remaining three circuits are fixed to avoid the dip in the middle of the response curve which would otherwise be pronounced. With this arrangement the width of the band can be varied from 4 to 32 kc/s, corresponding to an audio-frequency response of 2,000 to 16,000 cycles. Ganged to the variable selectivity knob are two subsidiary controls, one a potentiometer controlling the standing bias on the IF valves in order to prevent too wide a change of sensitivity between the high selectivity and high fidelity positions, and the other a rotary switch controlling a number of by-pass condensers across the anodes of the second push-pull LF stage which give an audio-frequency cut-off approximately the same as that introduced by the narrowing of the band width. In this way, also, the same degree of tone control is available on gramophone reproduction as is given by the variable selectivity control on radio.

The second detector is a triode connected to function as a low-impedance diode. The load resistance forms the volume control potentiometer. Its low

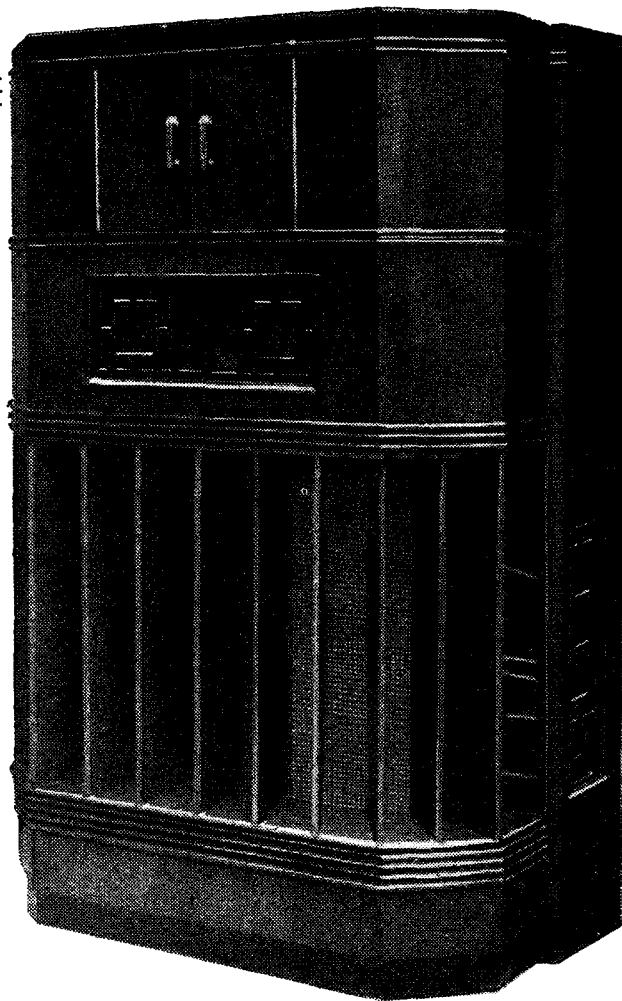

Cabinets are built to special order and the above example, the Laureate Grande, costs 50 gns.

resistance maintains the audio frequency output in the extreme top, and by suitable matching with the diode impedance avoids modulation distortion. The main AVC control to the IF valves and the frequency-changer or mixer valve is taken through a filter from the diode load resistance.

Auxiliary AVC System

A separate AVC system controls the HF amplifier on all wavebands and the mixer valve on the normal broadcast bands. For this purpose a diode-tetrode valve is used, the electrodes of which, as in most American valves, have been suitably adapted to the requirements of the circuit. A part of the output from the anode of the mixer valve is applied to the control grid, and a broadly tuned IF circuit in the anode is coupled to the diode portion of the valve which rectifies it and applies the resulting DC voltage as full AVC to the grid of the HF amplifier. In this way the HF and mixer valves are protected from overloading in the presence of a strong signal on a channel adjacent to a weak distant station to which the set may be tuned.

The noise suppressor valve works on a somewhat different principle from that to which we are accustomed in this country. Its function is to prevent the AVC voltage from falling below a given value which is determined by the sensitivity control on the front of the set. At the same time it

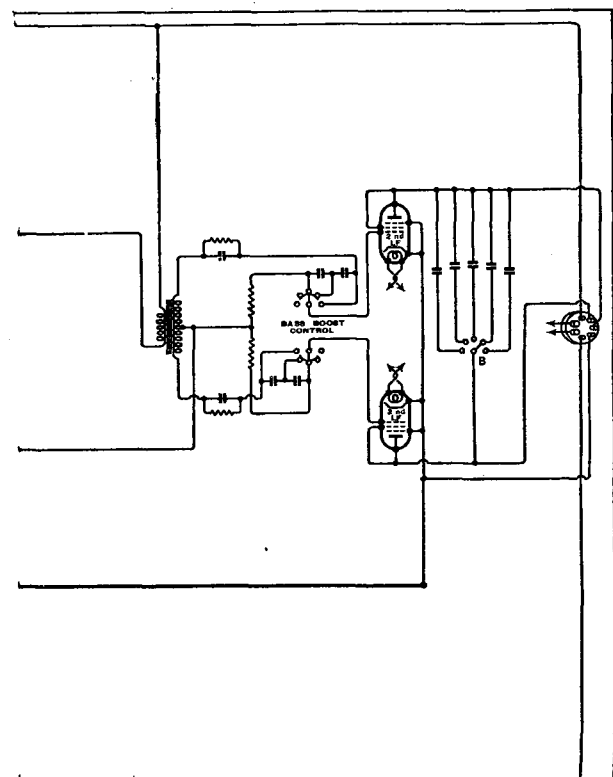

Circuit diagram of receiver chassis. There are two independent AVC systems and auxiliary valves are used for noise suppression, CW reception and the operation of the tuning indicator. The variable selectivity control adjusts simultaneously the IF condensers A, the tone control B, and the sensitivity compensator C.

Scott Hi-Fidelity All-wave Superhet— does not affect AVC voltage variations above this value. The valve is a triode connected as a low impedance diode with its grid taken to the AVC line and the other two electrodes joined to some variable source of negative potential—actually the slider of the sensitivity control. So long as the grid remains more negative than the cathode no current flows and the AVC is unaffected, but if the grid becomes less negative the valve becomes conductive and the AVC line is maintained at the potential of the sensitivity control slider.

The beat oscillator can be used for the reception of CW Morse signals, and is also extremely useful in detecting the presence of what is suspected to be a weak unmodulated carrier. It is controlled by a press-button on the front panel which makes the HT connection to the anode. The oscillator is placed near the second detector stage and is adjusted to beat with the intermediate frequency. The beat note is adjustable by a trimmer at the back of the set.

There are two stages of LF amplification between the second detector and the

that the receiver may be used for distant listening after other members of the household have retired.

The four triode output valves give an undistorted output of 35 watts, which is capable of dealing with peaks even when the general level is far above that which can be tolerated in the average living room. Between the anodes and the output transformer primary is a balanced section filter giving a sharp crevasse in the audio-frequency response to eliminate the heterodyne between stations. In America this filter is adjusted to 10 kc/s, but sets sold in this country are fitted with a 9 kc/s filter. Incidentally, the European model differs from the American original in the waveranges provided. In the former there are two short waveranges and long and medium broadcast bands, while in the latter there is the usual medium broadcast band and three short waveranges.

The loud speaker system consists of a main unit and two high-frequency units fed in parallel with the speech coil of the main speaker through a series condenser designed to give a change-over at 2,000 cycles. The fields of the tweeters are connected in series and form a potentiometer

The tuning scale is marked in kilocycles and is as accurate as it is possible to read the hair line. The ganged tuning condensers are driven by a two-speed slow-motion drive incorporating a small change-speed lever immediately below the knob. No station names are indicated, and the reason for this will be obvious when one has become acquainted with the capabilities of the set. The kilocycle markings on the transparent drum-type scale are projected together with the image of the tuning indicator on to a frosted window divided vertically into four coloured columns corresponding with coloured dots on the wave-range switch.

The knobs on the extreme left and right are the main volume and selectivity controls respectively. In spite of the sensitivity compensation incorporated with the selectivity control it is advisable to turn back the volume control before increasing selectivity as this up to a point is still accompanied by an appreciable increase of volume. The set should always be first tuned in with reasonably high selectivity in order that a single peak indication may be given on the tuning indicator.

The remaining controls are the sensitivity control which limits the rise of background noise between stations, and the bass boost which is useful in changing the frequency response to suit speech and music respectively.

Response to Transients

There is a wonderful feeling of spaciousness and freedom in the quality of reproduction. The output stage, which is capable of delivering 35 watts undistorted, gives ample room for the development of peaks when working at a general level of, say, 5 watts. This and the wide frequency response together contribute to an attack which is without the slightest trace of blurring and reveals the limitations of the lower-powered sets to which we have become accustomed. The main loud speaker and the two tweeters are all fitted with the latest type of exponentially curved cones so that there is little likelihood of the development of sub-harmonics at the high volume levels of which the set is capable. A slight tendency to the over-emphasis of sibilants was the only criticism which could be levelled at the reproduction, and it is more than likely that this may have been due to the particular type of microphone which happened to be in use when the quality of speech was under review.

It is not many years since the employment of more than five or six stages in cascade would have resulted in an intolerably high level of background noise. In the Scott receiver, with the set tuned to a station, or with the aerial disconnected from the aerial terminal, the background noise would do credit to an LF amplifier without any stages of HF or IF amplification. It is true that the background noise rises between stations, but the level is limited by the position of the sensitivity control on the front panel. Even so, the background noise is, if anything, less than that in the

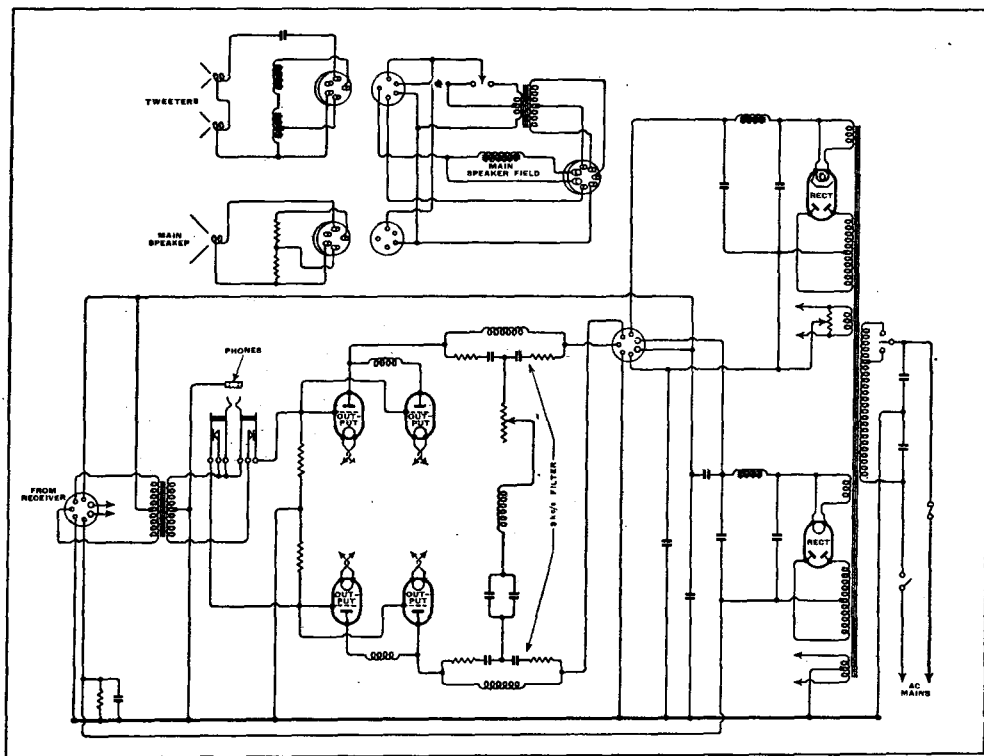

Circuit diagram of power pack, output stage, and loud-speaker system.

output valves. The first is a single triode and the second a push-pull stage with multi-electrode valves arranged as triodes. In the grid leads of these valves are fixed resistance-capacity filters to raise the high note response and keep the overall characteristic flat to 16,000 cycles. In addition, there is a variable bass boost filter by which the response in that region can be adjusted to suit the cabinet in which the set is installed, and also to obtain the best results on both speech and music. The push-pull transformer coupling this stage to the output valves has a telephone jack connected in its secondary circuit, so

for supplying the bias to the output valves. The tweeters can be omitted if desired, and by a rearrangement of the connection plugs a suitable resistance potentiometer is substituted for the bias. The power supply is derived from two independent rectifiers fed from separate windings on the mains transformer. One of these rectifiers supplies the anode current to the output valves, which may fluctuate on maximum power, while the other supplies the main HT current for the set and also the bias to the output valves. The power consumption of the whole set is of the order of 200 watts.

Scott Hi-Fidelity All-wave Superhet— simpler types of four-valve superheterodyne, and taking into account the enormous overall amplification of the set the signal-to-noise ratio has never been bettered on any set which we have so far tested.

It is on the short waves that this feature is seen to best advantage, and there is no necessity to wait for favourable con-

ditions before attempting to tune in the short-wave broadcasting stations on the other side of the Atlantic. During the period of the test, which extended for the greater part of a week, at least three reliable American stations could always be tuned in from the commencement of their programmes in the late morning. All of them gave a workable deflection on the tuning indicator, and were never completely lost even at the deepest fading troughs.

done, and is convincing proof of the efficacy of the dual AVC system. With the set working at high sensitivity we were rather perturbed to find a number of self-generated whistles which had not shown themselves under normal working conditions. These were ultimately traced to the London Regional transmission, and a wave-trap in the aerial lead effected a complete cure.

The medium waveband is as full of stations during the day time as the ordinary set is at night, and if the long wave performance does not at first appear to show any superiority as far as the broadcasting stations are concerned, one has only to listen to a few aeroplane transmissions on the 900-metre band to realise that the extra range is there. Applying the usual test for selectivity on the long waves, it was found that the Deutschlandsender could be cleared of interference from Droitwich and Radio-Paris with the selectivity increased only slightly above that normally used for general listening and with excellent, if not full, "high-fidelity" quality. The selectivity on the medium waveband was even more remarkable, for in Central London it was found possible to separate Turin and London National on adjacent channels with a clear space between. This, of course, called for the maximum selectivity of which the set is capable, and under these conditions quality was low pitched; but it showed what could be

Following the precedent of certain makers of quality motor cars, the sale of the chassis, complete with loud speakers and a set of spare valves, constitutes the basic transaction. The customer then has the choice of about twenty cabinets, ranging in price from 10 to 150 guineas, which are built to special order. The most luxurious equipment of all is to be found in the Warwick Grande Special, which, complete with record-changer for 30 discs and a professional type recording instrument, costs £12 10s.

The privileges of possessing such a receiver are naturally reserved for the few, but the humbler amateur will not, on that account, withhold his appreciation of the technical merit of the design.

H. J. B. Microphone

THIS is a carbon microphone of the small button type to which is fitted a free, or undamped diaphragm, the whole being enclosed in a rectangular metal case having a wire gauze front. The microphone is suspended by three springs in a circular frame and supported on a short stand, the overall height being approximately 12in.

The base is hollow and contains the transformer. On the base are four terminals, two for the battery and two for the output. The microphone polarising voltage can be obtained from a 9-volt grid battery, though for normal use about 4½ volts only is needed.

This microphone is well suited for home entertainment purposes; it does not require a large amplifier and works well when connected to the pick-up terminals of any broadcast set.

Many amusing experiments can be made with a microphone in this manner at small cost, for the price of the H. J. B. instrument is but 10s. It is obtainable from H. J. Bennett.

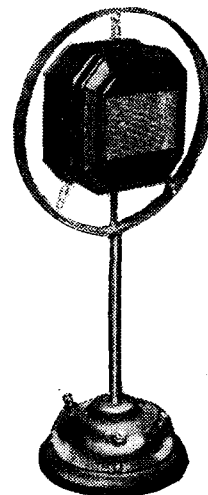

H. J. B. carbon button microphone.

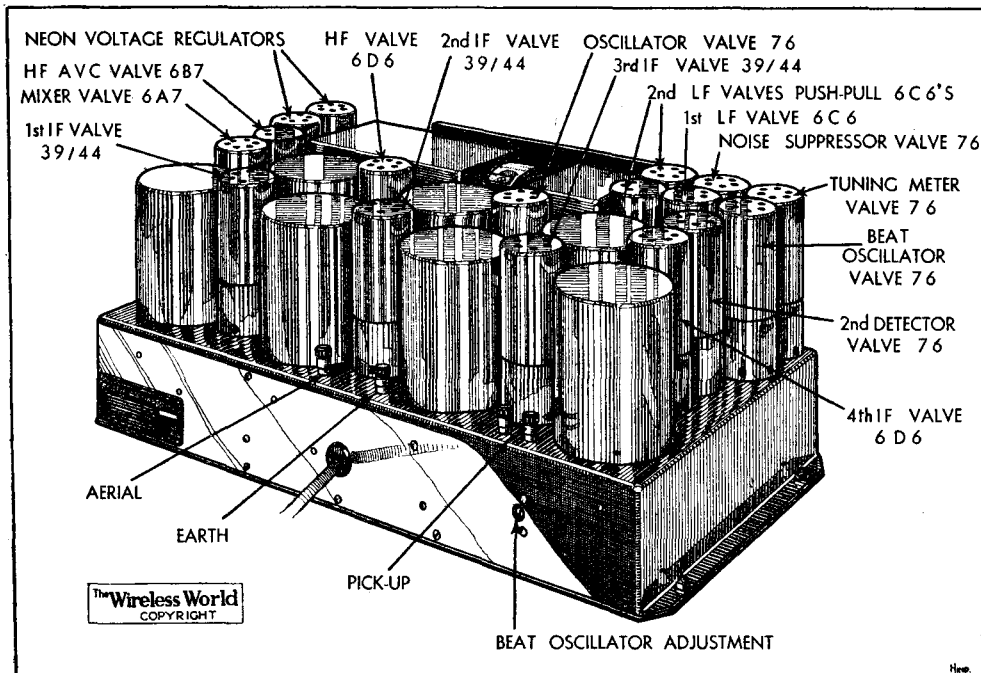

(Above) Every valve in the receiver chassis, including the LF stages, is screened.

(Right) The power pack which includes two separate rectifiers also carries the four output valves.

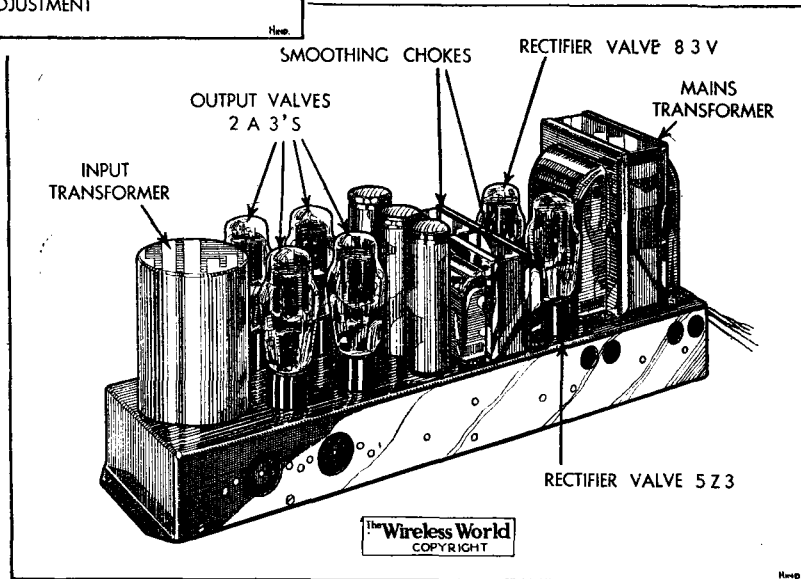

New Circuit Book

A SECOND edition of "Radio Progress" has just been issued by A. F. Bulgin, Ltd., Abbey Road, Barking, Essex. Like its predecessor, this useful book contains circuit diagrams, practical wiring plans and constructional details for ten different receivers, amplifiers, and short-wave converters. New material has been added, and the contents revised. The book costs 1s.

Two interesting all-wave universal mains superheterodynes are described. The first, covering waves between 10 and 2,000 metres in five steps, is primarily a short-wave set, while the other is more of the general-purpose type, with four wave-ranges starting at 15 metres. A 5-watt DC mains amplifier has been added. This is a two-stage instrument with push-pull output pentodes.

CHOKE INPUT FILTERS

Improving the Regulation of the HT System

IN normal AC receiver practice the output from the HT rectifier is applied across a condenser, which forms the input of the smoothing system. The author of this article describes the alternative use of a series-connected choke of special design, and precedes his discussion of this system and its advantages by a detailed examination of the processes of rectification and smoothing

By N. PARTRIDGE, B.Sc., A.M.I.E.E.

TWO steps are necessary for the production of ripple-free DC from an AC source. The first is to render the current unidirectional (but not necessarily constant in value), and the second is to smooth out the irregularities.

The simplest way of obtaining unidirectional current is to use the well-known half-wave rectifier circuit of Fig. 1a, where the resistance R represents the load. Fig. 1b shows graphically the voltage curve across the transformer terminals and also the unidirectional humps of current that occur each positive half-cycle. It follows from Ohm's Law ($V = IR$) that the voltage wave-form across a purely resistive load will be the same shape as the current wave-form, and the peak value will be the peak volt-

and, but for the small drop in the valves, is of the same magnitude as the voltage of one half of the transformer secondary. Hence the DC or mean voltage across a resistive load will be independent of the current flowing and will be numerically equal to the RMS voltage of the transformer divided by 1.11.

Having obtained a current that flows in one direction only it remains to remove the various AC components that are responsible for the cyclic variation of magnitude. This is generally done by placing inductances in series with the load and condensers in parallel with it. An inductance opposes any change of current by generating a back-EMF tending to maintain the current at a constant value, while a condenser opposes any change of voltage across its terminals by absorbing power in the form of a charge when the voltage is increased and by delivering power to the circuit when the voltage is diminished.

There are obviously two ways in which such a filter circuit can be built up. Either (1) by starting with a condenser, or (2) by making a choke of the first component. Figs. 2a and 2b illustrate the two arrangements. In this country the condenser input to the filter of Fig. 2a is usually employed and a study of Fig.

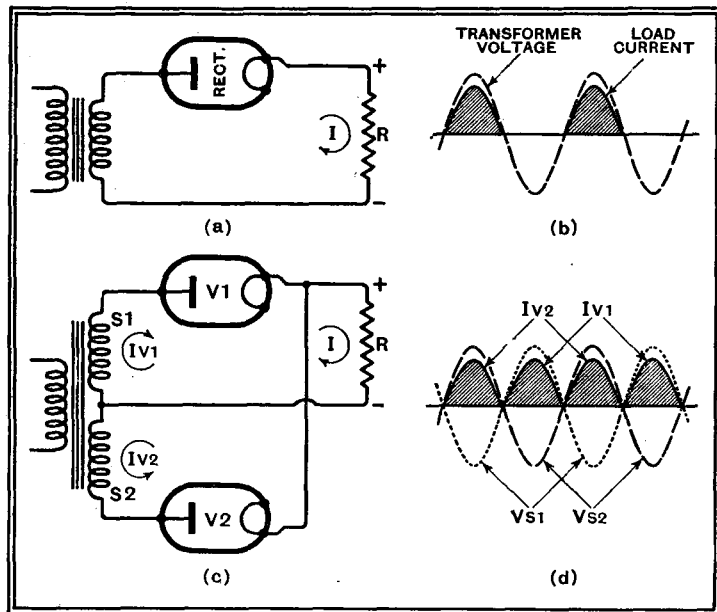

Fig. 1.—Half-wave and full-wave rectifiers, with relationship between input voltage and rectified current output.

age of the transformer ($=\text{RMS volts} \times 1.4$) less the small drop in the rectifying valve.

The combination of two half-wave circuits in such a way that each passes current alternately gives the more usual full-wave rectifying circuit of Fig. 1c. Fig. 1d illustrates the voltage curves for the two halves of the transformer secondary, S₁ and S₂, with respect to the centre point, and also the unidirectional load current or voltage wave-form. It should be noted that the load voltage follows a series of half waves

3 will indicate how the circuit functions. The upper section of the diagram shows the voltages of the transformer HT windings, together with the wave-form of the voltage across the first or reservoir condenser; the lower section indicates the currents passing through the rectifier and transformer windings.

Each time the transformer voltage reaches a peak value the condenser receives a charge, first through one rectifier and then through the other. When the transformer voltage falls the condenser

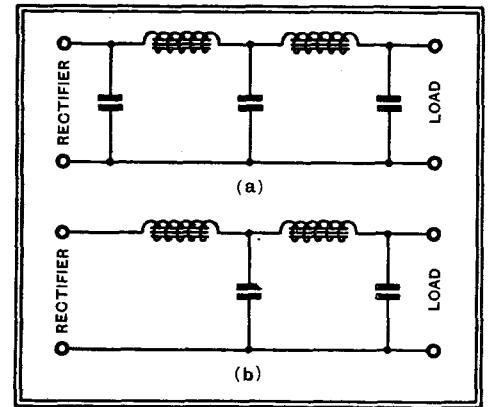

Fig. 2.—Two types of input to the smoothing circuit: dia. a, condenser; dia. b, choke.

discharges and supplies current to the load; thus the voltage across its terminals drops less rapidly than the transformer voltage and continues to fall steadily until the transformer voltage approaches the next crest, when a further change is absorbed and the cycle repeated.

If the capacity of the reservoir condenser were infinitely great it would be able to discharge into the load without any drop occurring across its terminals, and the voltage would therefore remain fixed at the peak value of the transformer voltage. As the capacity of the condenser is reduced it becomes less able to supply the current demanded by the load, and the voltage drop between successive charges becomes greater. Similarly, with any fixed value of capacity the voltage will remain constant at the peak value if no current is taken by the load, but will fall more and more between each charge as the load current is increased.

Reservoir Condenser Capacity

It is clear from the foregoing that the rectifiers pass current during only a small part of the cycle. Since all the current delivered to the load must necessarily flow through the rectifiers it follows that the impulses of charging must be greatly in excess of the mean current passing through the load. The shorter the period of charging, i.e., the larger the reservoir condenser, the greater must be the surge of current passed by the rectifiers. For this

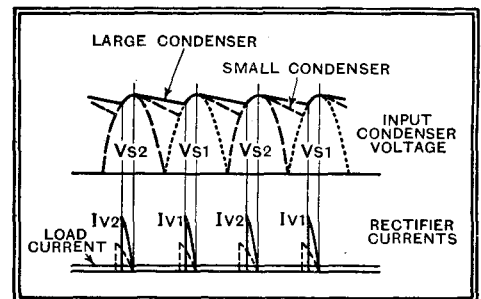

Fig. 3.—Operation of a smoothing circuit with condenser input.

Choke Input Filters—

reason British valve manufacturers stipulate that the reservoir condenser must not exceed 4 mfd. ; if a larger condenser than this is used the valve life will be reduced.

Another effect of these "peaky" charging surges is to make the design of the mains transformer more bulky. The larger the peak value of current passing through the transformer winding the greater will be the RMS value of the current compared with the mean value. For example, if with a 4-mfd. reservoir condenser the load takes, say, 60 mA smoothed DC, it is obvious that each half of the transformer secondary must be passing 30 mA DC, as measured by a moving-coil instrument. If, however, the RMS current through each half of the HT winding be measured with a moving iron instrument, it will be found to be of the order of 50 to 60 mA. The larger the reservoir condenser the greater is the discrepancy between the mean and the RMS current. With the standard 4-mfd. condenser the transformer HT secondary must be wound to carry double the useful current required from it by the load.

Disadvantages of Condenser Input

To sum up, a condenser input to the filter results in (a) an output voltage in excess of the mean voltage of the transformer secondary, (b) poor regulation, since with no load the output voltage equals the peak voltage of the transformer and approaches more and more the mean voltage of the transformer (=0.636 times the peak value) as the load current is increased, (c) heavy peak currents through the rectifier which limit the power-handling

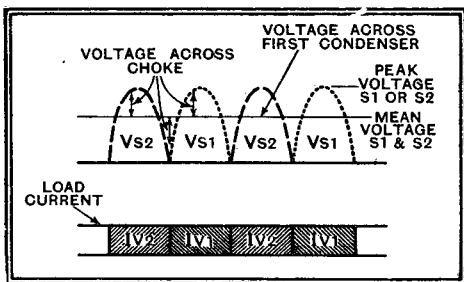

Fig. 4.—Conditions prevailing in a smoothing circuit with an input choke of infinite impedance.

capacity of the valve, and (d) an inefficient transformer design, since the HT secondary must be capable of carrying larger currents than are demanded by the useful load.

The action of the circuit of Fig. 2b can be most easily pictured if the input inductance is imagined to be infinitely large. The current through the choke will then be maintained constant, since an infinite inductance will generate sufficient back-EMF to counteract any variations of current that tend to arise. Fig. 4 shows graphically the conditions prevailing in the circuit.

The voltage delivered by the transformer is represented by a series of half waves as before. Since the current through the rectifier remains constant for

the reason already stated, it follows that each anode must deliver a square-topped wave form. For this to happen a constant voltage must be applied alternately to each anode for the period of half a cycle, hence it can be deduced that the back-EMF across the choke at any instant will be the difference between the mean transformer voltage and the instantaneous transformer voltage. The wave-shape of this induced voltage will be the same as the transformer voltage curve but with its zero on the mean output voltage line (see Fig. 4). The peak value is clearly equal to the mean voltage of the transformer secondary, which is numerically equal to the RMS voltage divided by 1.11. A choke used in this position of the circuit must be specially designed and manufactured to

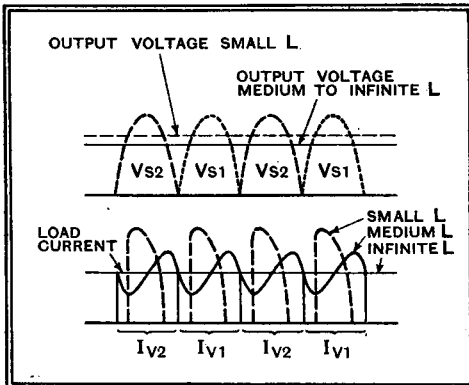

Fig. 5.—Operation of a choke input circuit with various inductance values.

withstand a high terminal voltage; the usual pile-wound smoothing choke is quite inadequate and would quickly break down.

At this juncture it is possible to compare the behaviour of this circuit with that of the condenser input arrangement. (a) Neglecting the small drop in the valves and in the resistance of the choke winding, the output voltage will be equal to that of the mean value of the transformer voltage, (b) the output voltage will be independent of the load, i.e., perfect regulation, (c) the peak current through the rectifier will be equal to the load current, hence a given valve can deliver a larger load current than when used with a condenser input filter, (d) the smoother wave-form of the current through the transformer windings will give a more efficient transformer design, since the RMS current will more nearly approach the mean value.

Under Practical Conditions

The preceding discussion has assumed an infinite inductance. In practice this condition cannot be attained, and Fig. 5 shows the circuit conditions when the inductance is reduced to practical values. It will be noticed that with a medium inductance the rectifiers do not pass a steady current, but, nevertheless, current flows continuously. When the inductance becomes small the continuity of flow is broken and there are periods when no current is flowing through either rectifier. As the inductance is reduced, so the cir-

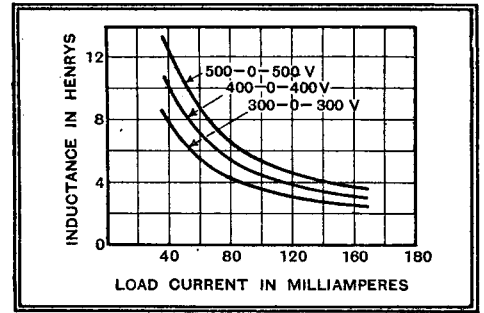

Fig. 6.—Effect on load current of input choke inductance.

cuit conditions become more and more similar to those of the condenser input arrangement.

The value of inductance at which the current through the rectifiers is just continuous is very important. It marks the point at which the above-mentioned advantages of the circuit rapidly lose their full value. The mathematical calculation of this critical inductance is rather involved, as it depends upon the transformer voltage, DC load current, value of condenser immediately following the choke, and to a lesser extent upon the values of the components used in the remainder of the filter circuit. The curves of Fig. 6 give the inductance in henrys for three different transformer voltages and for currents from 40 to 160 mA; the curves assume a 4-mfd. condenser immediately following the choke. If the inductance falls below the value indicated by the curves the output voltage across the condenser will rise above the mean value of the transformer voltage. If the inductance is in excess of the figures given, the voltage will not be affected, but the choke will contribute more effectively to the smoothing of the DC output.

(To be concluded.)

THE RADIO INDUSTRY

A PUBLIC address van fitted with a Magnavox "66" speaker was shown by Stewart & Arden at the recent Commercial Motor Show. The speaker, housed in a torpedo-shaped baffle mounted above the roof, is highly directional and can be rotated by the operator from inside the van.

A catalogue of specialised "Raymart" short-wave components (including parts for amateur transmitters) is issued (price 1½d.) by The Radio Mart, 19, John Bright Street, Birmingham, 1.

A leaflet describing new Fydeltone extension speakers is issued by Baker's Selhurst Radio, Ltd., 75 and 77, Sussex Road, Croydon, Surrey. The instruments are available with or without transformers and with built-in volume control and on-off switch.

Britannia Batteries, Ltd., notify us that the telephone number of the Pertrix depot at Hull is Hull 36389. Incidentally, the latest Pertrix lists deal with HT batteries in eight capacities, and also with a series of special replacement batteries for popular receivers. The general catalogue describes a series of accumulators and bias batteries as well. Copies are obtainable from Britannia Batteries, Ltd., Redditch, Worcs.

A catalogue of Telsen Radio Components for 1935-36 has just been issued by the Telsen Electric Co., Ltd., Fitzgeorge St., Manchester, 9.

Listeners' Gu

A RADIO CHRISTMAS

CHRISTMAS without wireless would nowadays be rather like turkey minus plum pudding, or cigars minus the band. However, enough of this deep moralising. . . . The task is to pick out the gems from a cluster of Yuletide brilliants. Certainly no Christmas has been more "radio" than this one.

CURTAIN-RAISERS

THE curtain goes up on Monday with a potted pantomime, "Aladdin" (Reg., 7.15). At 8 both National and Regional are giving Christmas items, the former the miracle play, "The Stranger at St. Hilary," by the Rev. Bernard Walke, re-played from the old Cornish village of Marazion, and the latter a programme of "Carols from Other Countries," given by the B.B.C. Singers, directed by Sir Richard Terry.



"THE STRANGER AT ST. HILARY"—a miracle play—comes from Marazion, Cornwall, on Monday (Nat., 8).

"Tunes of the Year" (Reg., 8.30) will be a musical anthology of the most popular melodies of 1935, by the B.B.C. Theatre Orchestra supported by Henry Hall and the B.B.C. Dance Orchestra, the two playing alternately.

CHRISTMAS EVE

MANY of the carols to be broadcast from King's College Chapel, Cambridge, on the afternoon of Christmas Eve are seldom or never sung except on the occasion of this beautiful service in what is, acoustically at least, one of the finest buildings in the country. Following the Cambridge relay



THE TWO LESLIES (Leslie Holmes and Leslie Sarony) take part in the Christmas Party broadcast on Wednesday. On the right is Bransby Williams, appearing in a Dickens fantasy on Christmas Eve (Nat., 8).

more carols will be broadcast in the evening from St. Mary's Church, Whitechapel.

That inimitable character actor, Bransby Williams, comes to the National microphone at 8 with "A Dickens Christmas Eve Fancy." On the Regional wavelength at 8.20 the curious radio melodrama, "Reconnaissance," by Geoffrey Askew and E. J. King Bull, will be given. This play, first broadcast in February, 1934, aims at a new technique in which musical "scenery" helps to picture the thoughts of three men in a lost 'plane.

CHRISTMAS DAY

THE chief event is, of course, the annual broadcast of His Majesty The King, who will speak to his subjects all over the world at approximately 3 o'clock. The Royal Message will be introduced by a child in New Zealand who is staying up late (it will be nearly three o'clock in the morning) to hear the King. This will be the culminating point in the "Round the Empire" programme which opens at 2.30, preceded by the bells of Bethlehem at 2.25.

The most unusual broadcast of the day will be that of the Boar's Head ceremony from Queen's College, Oxford, at 7.15. This occasion is both historic and amusing. Queen's College tradition has it that a student studying Aristotle in the woods, attacked by a

BRINGING IN THE BOAR'S HEAD at Queen's College, Oxford—a print of 1846. The ceremony, which will be broadcast on Christmas Day, originated seven or eight hundred years ago.

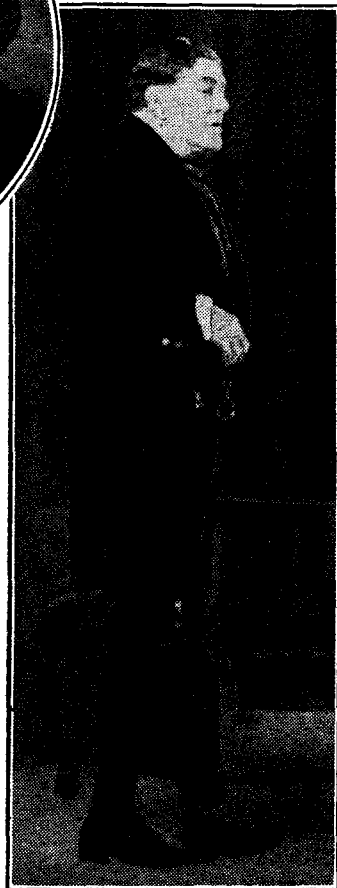

wild boar, crammed the volume down the animal's throat, choking him. It is said to be in memory of this deliverance that the ceremony of the Boar's Head was instituted, probably 800 years ago. In this broadcast a B.B.C. observer will describe the ceremony from a point of vantage in the gallery.

Informal jollity will reach its climax in the annual Christmas Party broadcast from St. George's Hall, which will last

two hours, from 7.30 to 9.30, listeners being invited to join in at any time and take their chance. Besides musical games, chatter, songs, and Christmas stories, an Elizabethan Charade will be staged, the actors including Clapham and Dwyer, Stainless Stephen, Tommy Handley, the Two Leslies (Leslie Sarony and Leslie Holmes), and many other radio favourites. It is hoped that Gracie Fields may contribute to the programme from Johannesburg.

To round off Christmas Day there will be a special "Henry Hall's Hour."

BOXING DAY

ANTI-CLIMAX is not apparent in the B.B.C. programmes for December 26th. At 7.30 (Nat.) the Kentucky Minstrels are holding a Christmas Party, and an hour later, in the Reg. programme, Sir Seymour Hicks will impersonate "Scrooge."

Appropriately enough, there will be an excerpt from the Drury Lane pantomime, "Jack and the Beanstalk," at 10.20.

ANNA PAVLOVA

PAVLOVA, queen of ballet and one of Russia's most brilliant ballerinas, is to have a commemorative hour in the programme to-night (Friday). Walford Hyden, who was Pavlova's ballet conductor, has chosen the music and written an introduction to the incidents in her life which will be portrayed. Cleo Nordi, wife of

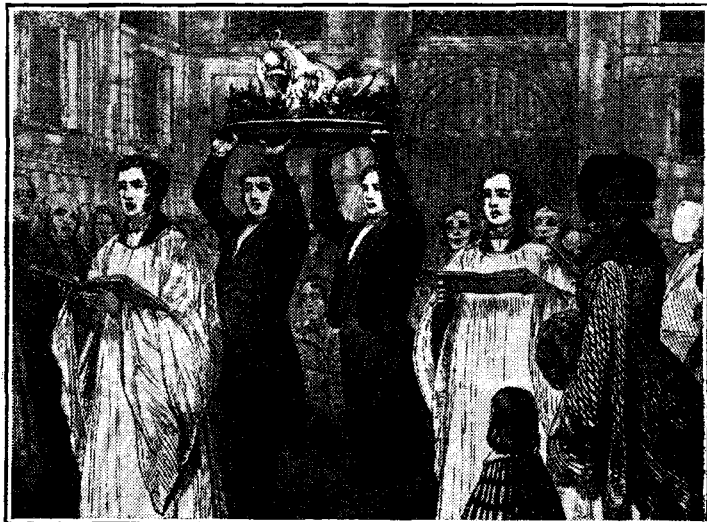

de for the Week

Outstanding Broadcasts at Home and Abroad

HIGHLIGHTS OF THE WEEK

FRIDAY, DECEMBER 20th.
Nat., 8, "Anna Pavlova." 10, "Sarah Bernhardt," by James Agate. 10.20, B.B.C. Contemporary Music Concert. Reg., 7.15, B.B.C. Dance Band. 9, Songs from the Shows. 10.30, Roy Fox and his Band.

Abroad.

Hilversum (1,875 m.), 7.45, The Dordrecht Orchestra.

SATURDAY, DECEMBER 21st.
Nat., Gaelic Song Recital by James McPhee. 8, Gala Variety. B.B.C. Orchestra.

Reg., 8.35, "Hansel and Gretel" (Humperdinck) from Sadler's Wells. Four-hand piano Recital: Alec Rowley and Edgar Moy. Henry Hall's Hour.

Abroad.

Stuttgart, 7.10, "The Daughter of the Regiment" (Donizetti).

SUNDAY, DECEMBER 22nd.
Nat., 1.30, Eugene Pini and his Tango Orchestra. 6.55, Olga Haley (mezzo-soprano), Pouishnoff (piano). 9, Bourmemouth Municipal Orchestra.

Reg., 4.30, The Celebrity Trio. 9.20, Sunday Orchestral Concert.

MONDAY, DECEMBER 23rd.
Nat., 8, Miracle Play, "The Stranger at St. Hilary." B.B.C. Orchestra.

Reg., 7.15, Potted Panto: "Aladdin." (from North). 8.30, Tunes of the Year.

Abroad.

Munich, 8, "Peasant Legend"—Christmas Play with Music.

TUESDAY, DECEMBER 24th.
Nat., 8, Bransby Williams. 8.15, "All Girls Together." 10, "The Little Show."

Reg., 8.30, Radio Play: "Reconnaissance." 9, B.B.C. Orchestra.

Abroad.

Kalundborg, 6.30, Christmas Eve Concert.

WEDNESDAY,
DECEMBER 25th.

Nat., 2.25, Bells of Bethlehem. 2.30, "This Great Family." 3, Message of H.M. The King. 6.10, "Unto Us"—a Pageant of Christmas. 7.15, Boar's Head Ceremony. 7.30, Christmas Party. 9.40, Lord Sankey's "Wireless for the Blind" Appeal. Reg., 8.15, B.B.C. Orchestra. 11, Henry Hall's Hour.

Abroad.

Kalundborg, 5.30, Old Christmas Carols.

Deutschlandsender, 7, Festival Music.

THURSDAY, DECEMBER 26th.
Nat., 7.30, Kentucky Minstrels' Christmas Party. 8.30, Boyd Neel String Orchestra.

Reg., 8.30, Seymour Hicks as "Scrooge." 8.45, Reel Players (from Scottish). 11, Jack McCormick and Ambassadors Club Band, Liverpool.

Abroad.

Hamburg, 7, Operetta: "Der Opernball" (Heuberger).

Walford Hyden, herself a Russian and a member of Anna Pavlova's troupe, will speak these memory sketches at the microphone before each selection.



WALFORD HYDEN and his wife, Cleo Nordi, are presenting a programme of Pavlova memories to-night.

ALL THE BEST

In "Gala Variety," which comes back to-morrow evening, Eric Maschwitz attempts to rope in at the last moment any famous variety artist who hopes to be in London at the time. Austin Croom-Johnson

appeared in the December Revue, is staying for this broadcast. Mr. Flotsam and Mr. Jetsam have said that they will be in town, and there will be a new act—Billy Caryll and Hilda Mundy—which was very successful at the Palladium Crazy Shows. Look out for their brilliant quick-fire cross-talk.

CHRISTMAS ABROAD

WHY stay at home at Christmas? Quite a number of foreign stations offer excellent alternatives to the B.B.C. fare.

On Sunday the Deutschlandsender is relaying a rendering of Bach's Christmas Oratorio from the Academy of Singing at 6.30. The best Christmas novelty, however, is on Christmas Eve, when the bells of German cathedrals and churches throughout the country will be relayed in swift succession. Deutschlandsender begins at 5, with chimes from German cathedrals; at 5.45 Hamburg will take up the theme with chimes from the following churches: St. Michael's, Hamburg; St. Nicholas', Kiel; St. Nicholas', Flensburg; St. James', Stettin; Magdeburg Cathedral; the Market Church, Hanover; and Bremen Cathedral.

Kalundborg seems to provide the best Christmas Day programmes. At 5.30 there



GRACIE FIELDS, if etheric conditions are kind, will join the B.B.C.'s Christmas Party via beam from Johannesburg.

at 7 a pantomime (or more correctly a dramatic fairy tale), "Aladdin," will be relayed.

On Boxing Day Munich, at 7, offers "Five Centuries of Alpine Carols, Chimes, and Music."

SHAKESPEARE IN OPERA

NOT everyone favours Shakespeare in operatic form, but it is universally agreed that Verdi acquitted himself well in a task which would defeat most composers. Two of his Shakespearian operas are being broadcast this week: to-night Prague offers "Macbeth" at 6.30, and to-morrow Radio-Paris gives us a concert version of "Otello" at 8.45.

Other notable operatic transmissions are Donizetti's "Daughter of the Regiment," from Stuttgart to-morrow at 7.10, Respighi's "La Fiamma," from Budapest No. 1 at 6.30; Gounod's "Faust," from the Moscow short-wave transmitters (25 and 50 metres) at 4.30 on Sunday, and Wagner's "Mastersingers,"



SWEDISH RHYTHM. Ake Fagerbond's Band, which broadcasts from all Swedish stations to-morrow night (Saturday) at 9 o'clock.

will present one of his "Soft Lights and Sweet Music" periods, and Jean Sablon, who

will be old Christmas carols of the nations, including the English "I saw Three Ships";

from Munich at 5.5 on Wednesday, Furtwängler conducting. THE AUDITOR.

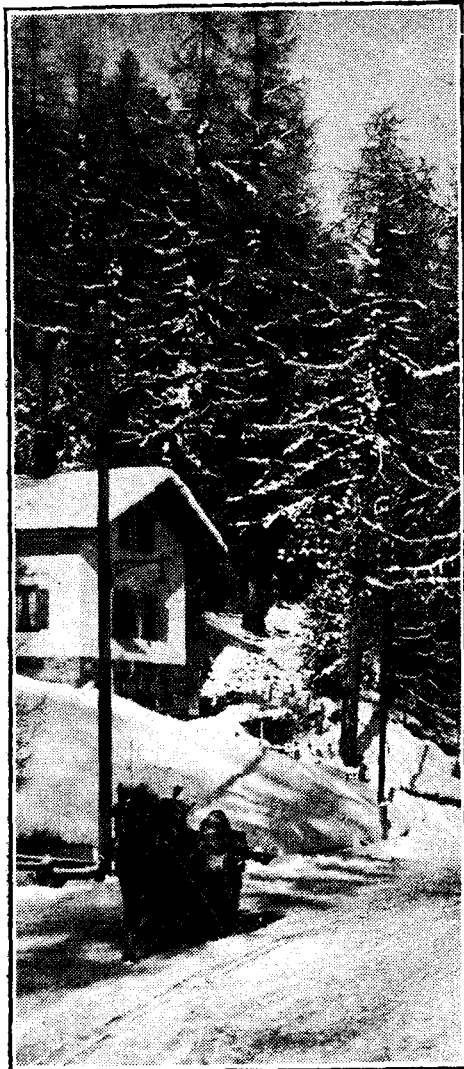

China.

A LADY is returning to China after an absence of seven years. She will be stationed at Kienyang, in the province of Fukien; that town is, I am told, some 80 to 100 miles from the port of Foochow.

She would be very glad of any information as to the nearest broadcasting stations, their wavelengths, etc., also as to reception of any English stations (short or long waves) which could be heard without an expensive receiver. Of course, any particulars of any public electricity supply in Kienyang would be useful—though I fancy relatively few Europeans have ever heard of that town!

A. K. TAYLOR.

7, Marston Road, Teddington, Middx.

The Life of Valves

I HAVE read with interest Mr. J. P. Green's letter in your issue of November 29th, and a word on my own experience with one particular set of valves may not be out of place.

I built the "W.W." Megavox Four receiver immediately the design was published. That was about September, 1928. Except for an interval of eleven months, this set has done constant duty as the family receiver; the ladies of the house work it anything from 1 to 3 hours per day. As far as I can tell by ear, the volume is as great as ever, while quality is reasonably good. I think this speaks well for the Mullard valves, which have thus done 6½ years of hard work.

Other mains and battery valves which I have used for S.W. and experimental work

Letters to the Editor

have given nothing like this service, and I entirely agree with your contributors that the average valve loses power after a year or so of continuous work.

I might take this opportunity of saying that the Megavox Four has been an excellent set. Its chief failing nowadays is in the matter of selectivity; and because of this it is shortly to be retired. Its place will be taken by the "Variable Selectivity IV," for which set I am now gathering the components. WILLIAM H. MACKINTOSH.

Service by Air

IT is hardly a new fashion that Messrs. G. Scott Sessions and Co. have set by sending a service engineer by air to Douglas, as reported in your November 29th issue.

It was in 1927 that we sent a service engineer to an English customer in Paris. He returned the same day.

For R. M. Radio, Ltd.,

E. J. BLOOMFIELD, Secretary.

London, W.C.2.

A Listeners' Association

I SEE in the *Daily Mail* of November 26th the suggestion that there is to be or should be a Listeners' Association to advise the B.B.C. on programmes. It behoves all those who see in broadcasting something more than a mental soporific for tired business men to fight any such idea tooth and nail. Any form of parliament of listeners must inevitably lead to majority government, and that will result not only in the lowering of programme standards, but in the Press gaining the virtual control of the B.B.C. The danger is more real and urgent, I am convinced, than is commonly supposed.

A. H. BRIDGES.

Brighton.

Pruning the Valve List

I READ with interest M. G. Scroggie's plea, in the Valve Supplement number of your journal, for a reduction in the number of valve types at present listed. Here are some of my ideas for what they are worth.

Mains valves are listed in an exceedingly large variety of heater ratings besides the standard 4-volt AC type. An alternative to this would be to list only one set of characteristics per valve type, stating the number of watts that the cathode requires from the heater. The valve could then be made available in a number of heater ratings. The type number would be the same for all ratings, as the characteristics would be the same. A certain valve would be spoken of as, for example, "Mazda 56," but it would be ordered as "Mazda 56, 13v. 0.2A." This would greatly reduce the bulk of mains valve lists, if the manufacturers could agree upon standard ranges of ratings to adopt—e.g., 13v., 4v., 0.2A, etc. The other factor would, of course, depend upon the wattage. Some AC valves have maximum anode voltages of over 250, and it obviously would not do to list them with valves for DC operation; but they are for the most part triode output valves which are, as M. G. S. points out, the exception rather than the rule. They should, therefore, be listed separately, with the reminder

that they are only available with 4v. heaters.

As the A.C. grid system gradually spreads, all but the 13v. (for car radio) and the 4v. heaters would automatically fall into disuse, there being no more demand for them. Years hence the car and radio people may possibly come to an agreement whereby one of the two change their system, necessitating only one set of heater voltages.

The types of valve that I consider should be completely cleared from the lists are the following. The battery power triode (except those involved in class "B," when the appropriate driver should be listed alongside the double valve). The triode has been bettered by the pentode, which is more sensitive and consumes less HT current. The single diode ought to be discontinued, since the double version costs very little more and can be used for full-wave detection, or half wave, using the other diode for AVC, and this is what is invariably done. And I entirely agree with M. G. S. about "fixed- μ " HF valves.

As to valve bases, I consider them fairly satisfactory, the number of pins being dictated by the needs of the valve. If only one type of base were used, it would have to be nine-pinned, to provide for such valves as duo-diode-pentodes, but a battery triode with nine pins is obviously quite absurd. In view of the fact that the battery triode is being superseded by more specialised valves, a good way out of the difficulty would be to standardise seven pins for all valves, except for the few that require nine.

In conclusion, I would like to record just one point in favour of multiple valves, and that is that they help to make a receiver more compact, and in certain cases, car radio for instance, this is highly desirable.

JOHN O. H. JACOBS.

Tiverton, Devon.

I HEARTILY agree with Mr. Scroggie's article in the November 29th issue. There is just one point to which I could take exception and I think it is of sufficient importance to bring it to your notice.

He seems to think that valves with a 13-volt heater should ultimately be discontinued. This, I think, is a mistake. The valves which should be discontinued are those with 4-volt heaters. The 13-volt valve is of great advantage in that it can be run off a car accumulator and, therefore, apparatus incorporating valves of this rating has portability and adaptability not known to apparatus using valves with a 4-volt heater. I do not suggest that these valves be designed for series running. Far from it. They would, indeed, lose many of their advantages if they were designed on a current instead of voltage basis.

Valve manufacturers would, therefore, seem to be effecting a maximum economy if they concentrated on producing a series of valves whose heaters could be used either on AC or fed from car batteries.

JOHN L. PINKERTON, 2BNL.

Ballymoney, N.I.

The Editor does not hold himself responsible for the opinions of his correspondents.



Heayberd 4-POINT RECEIVER

A Four-stage Superheterodyne in a Modern Cabinet

that the calibration is quite accurate. The settings of a few selected stations are also indicated, home and foreign stations being located on separate concentric circles.

Most of these stations were successfully received in daylight, so that their number is by no means representative of

average room, and the fact that the manual volume control does not require attention is a tribute to the efficiency of the AVC circuits.

It was found possible to approach within two channels of the Brookmans Park transmitters when using the set in Central London without experiencing any interference, and on the long waves the Deutschlandsender could definitely be included in the list of useful stations.

IN their literature the makers do not disclose the nature of the four points which enter into the title of this receiver, but surely one of them must be neatness. With the lid closed the overall dimensions of the cabinet are only 17in. x 10in. x 12in. deep, and there are no external controls to break the lines of the simple cabinet design. The main controls are four in number, and three are grouped round a clock-face tuning dial underneath the lid, while the fourth—the mains switch—instead of being associated with the volume control, as is usual, is at the back of the chassis.

The wavelength calibrations are in white on a black background, and although changes in the sub-divisions at different parts of the scale may lead to some confusion at first, it will be found

FEATURES. — *Type.* — Table model superheterodyne for AC mains. *Circuit.* — Octode frequency-changer—var.mu pentode IF amplifier—double-diode second detector—pentode output valve. *Full-wave valve rectifier.* **Controls.**—(1) Tuning. (2) Volume. (3) Waverange. (4) On-off switch. **Price.**—14 guineas. **Makers.**—F. C. Heayberd & Co.

the range of the set under night conditions. It is, in fact, very easy to form a false first impression of the sensitivity of the set, for the general behaviour has few of the earmarks of the so-called "hot-stuff" receiver. In traversing the waveband there are no sudden bursts from the loud speaker, and even with the volume control at maximum it is impossible to cause distortion by overloading the output stage. Yet the volume is quite sufficient for the

Points in the Circuit

A few second-channel and self-generated whistles could be found if deliberately looked for, but none of them caused any interference with a useful programme. Their low level, at least as far as the long waves are concerned, is attributable to a rejector circuit associated with the aerial band-pass filter. Bottom-end capacity coupling is used in this filter, which is connected to the octode frequency-changer.

The IF amplifier is of the variable- μ pentode type, and both this and the frequency-changer valve are controlled from the AVC line. A simple double-diode performs the functions of signal rectification and automatic volume control, the input for the latter being taken from the primary of the output IF transformer to minimise sideband distortion when tuning through a station. Resistance-capacity coupling is used between the diode and the output valve, and a resist-

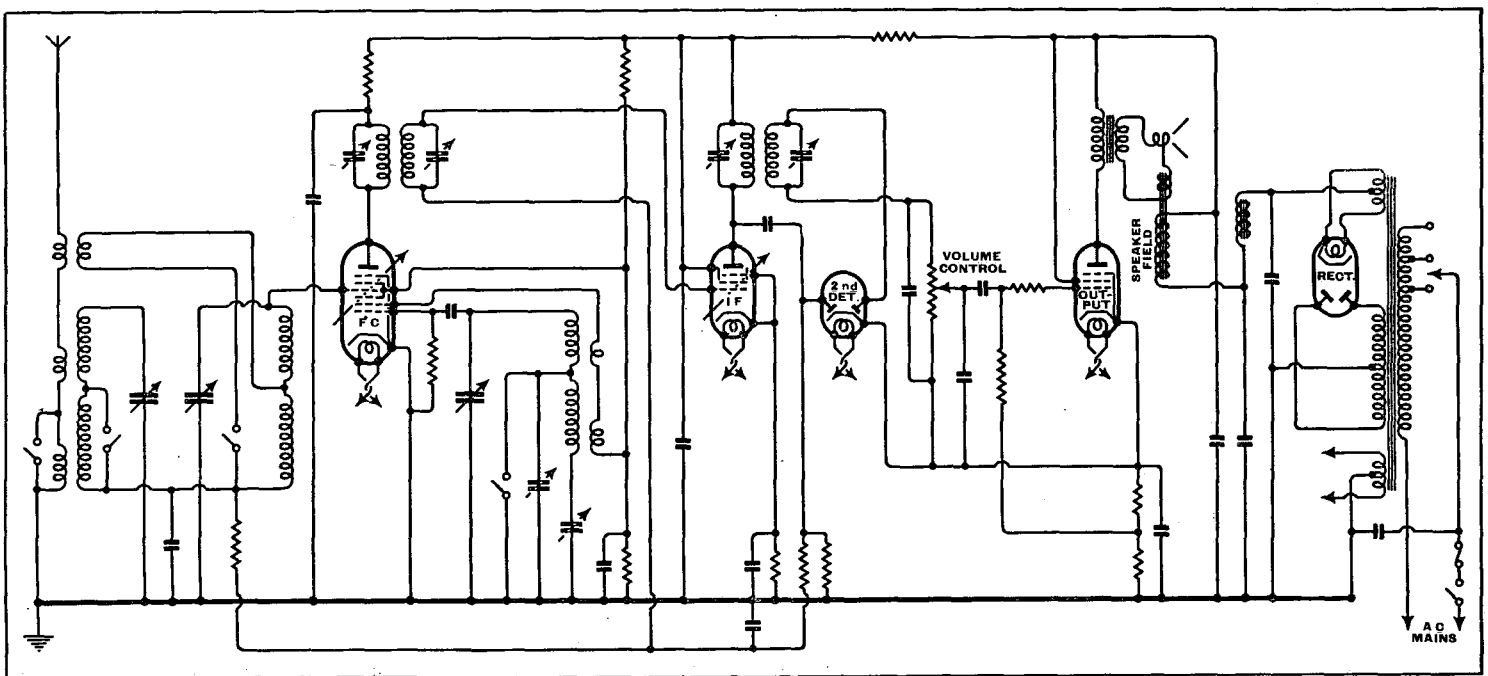

Refinements in the circuit include a whistle rejector in the band-pass filter and two stages of smoothing for the HT supply.

Heayberd 4-Point Receiver—

ance is connected in series with the grid of the latter valve to suppress stray HF currents. The rectified HT supply from the full-wave valve rectifier is smoothed by a separate choke in addition to the

The distribution of sound is good and there is no apparent focusing of the high notes. If asked to describe the quality with a single adjective, "smooth" would probably best meet the case. There is none of the hard

away with a clear conscience when they have served their turn, leaving us free to get new items better adapted to changing conditions. But a certain number of permanent reference standards are essential in order to set the knowledge gained on a firm quantitative basis.

So much for the essential qualities for which the instruments are designed and built. What of their range? The standard frequency equipments, beat-tone oscillators, precision wavemeters, are, of course, only within the means of large laboratories, broadcasting stations, and so on. The private experimenter is, however, not entirely beneath Sullivan's notice. There are, for example, a series of variable air condensers with good bearings from 25s. upwards, a junior model of the standard inductance coil at 25s., while at prices of the order of £20 there are a series of units comprising a very convenient universal wavemeter, covering the range 20 to 10,000 metres. This apparatus may be used as a dynatron oscillator, or as an absorption or heterodyne wavemeter.

The catalogue contains a great deal of useful information, and may be commended to all who are interested in measurements with any pretensions to accuracy. L. H.

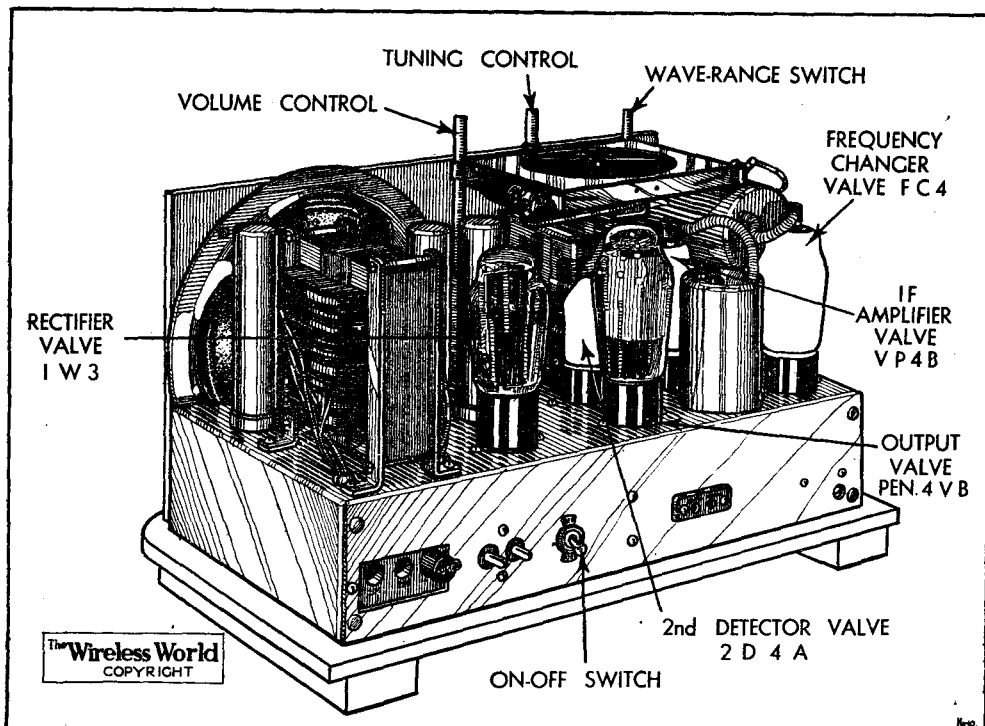

The mains on-off switch is mounted separately at the back of the chassis. Note the sectionalised power transformer.

smoothing obtained in the loud speaker field. A by-pass condenser is connected between one side of the mains and earth to minimise interference which might reach the set through this channel. With this arrangement it is advisable to reverse the mains plug to find the connection which gives best results.

Mains hum is completely absent from the output from the loud speaker.

brilliance which seems to be a feature of many receivers these days, and no part of the frequency range tends to mask the remainder.

The chassis is well-made and the mains transformer is notable for the fact that every winding is sectionalised. Each set is built throughout by one man, and special attention is given in testing to the accurate adjustment of the tuning scale.

Electrical Standards for Research and Industry

The New Catalogue of H. W. Sullivan, Ltd.

IF you have not seen a previous catalogue of the firm of H. W. Sullivan, Ltd., you may, on opening this fine volume, which they have just issued, experience a series of shocks as you notice that their best tuning coils cost about £15 each, their best variable condensers more than £50 each, and their best wavemeter £222. After this the sum of £500 for a complete primary frequency equipment with a standard harmonic wavemeter seems a mere trifle. You then ask yourself, "What do these colossal prices mean?" and the firm has thoughtfully printed the answer: "Sullivan guarantees accuracy."

And, indeed, the catalogue shows that no effort has been spared in the attempt to make standard components as perfect as modern materials and craftsmanship permit, regardless of expense within reasonable limits. Many of these instruments are very fine examples of the instrument-maker's craft. The variable condensers, for example, may be said to consist merely of a set of fixed plates and a set of moving plates

rotating on a spindle; essentially the same mechanism as the ordinary mass-produced article; but, whereas the one is chopped out and slammed together at the rate of thousands a day, the other is carefully built as an individual. Its construction cannot be hurried; the final state of all the material must be a stable one, and therefore ageing treatment is necessary at certain stages of the work. Again, the final accuracy is limited not only by the stability of the material but by the fit of all the parts, and especially of the bearing of the spindle. This must be of microscopic precision, and the motion must be so smooth that it is possible to make adjustments of a fineness that is only just visible on the scale. The whole business calls for the highest skill and meticulous care, and, viewed in this light, the prices are easily understood.

Of course, for qualitative experimental work we don't need this class of instrument. We expect our circuits to be obsolete in less than ten years' time, and it is good economics to use components that may be thrown

OSRAM U16 RECTIFIER

THE use of the cathode-ray tube for television has brought about a demand for high-voltage low-current rectifiers. The new Osram U16 is rated for an anode voltage of 5,000 volts RMS, and can give a rectified

output of 2 mA. It is of the directly heated type, with a filament consuming 0.25 ampere at 2 volts, and is fitted with a standard 4-pin base. Only the filament pins are used, however, for, in view of the high voltage, the anode is brought out to a top cap.



The new high-voltage rectifier.

The filament is of the oxide-coated type, and, as shown in the illustration, a flat-plate anode is used and supported from the pinch by long glass rods in order to avoid any risk of a breakdown

of insulation at the high voltage at which the valve is normally operated.

It is recommended that a 0.25 mfd. reservoir condenser be used, and smoothing can be carried out with a resistance of 100,000 ohms and a second 0.25 mfd. condenser. The condensers must be of high voltage rating, and in order to avoid damage to the rectifier in the event of a breakdown in a condenser it is recommended that a fuse be inserted in the lead to the anode of the rectifier. Following the usual practice with cathode-ray gear, the positive of the HT supply is earthed, and smoothing should consequently be inserted in the negative lead. It is advised that the inside end of the high-voltage winding on the mains transformer be the one which is earthed.

The valve is a welcome addition to the high-voltage rectifiers, and is priced at 20s.

Broadcast Brevities

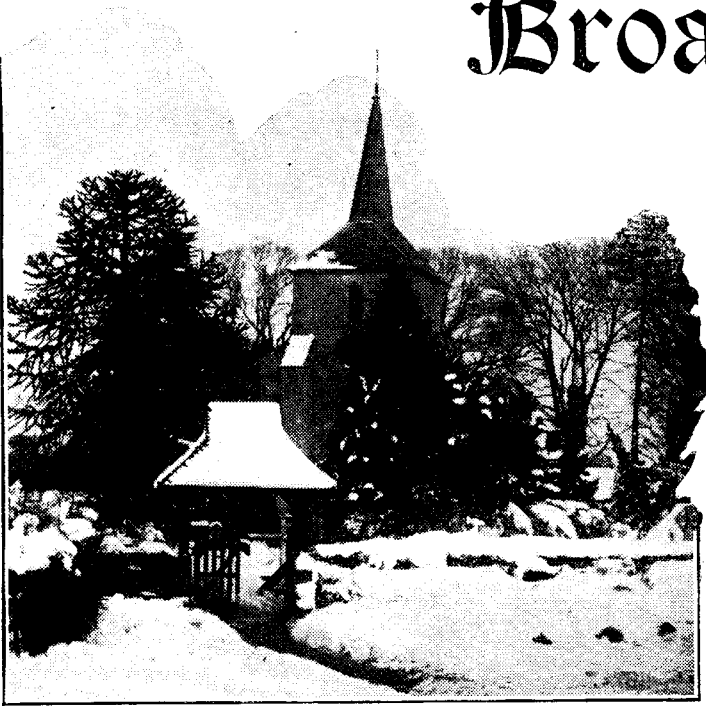

By Our Special Correspondent

The Great Day

"TELEVISION at Last," "B.B. See," "Television: New Plans"—these headlines screamed at me as I stepped into the office of a High Official at Broadcasting House last week, and for a moment I thought the great day had come. The newspaper posters adorned the wall behind the official's desk.

February 1st

One of the posters bore a date—February 1st—so evidently our well-informed "dailies" had been advised as to Mr. Gerald Cock's starting plans at the Alexandra Palace and had printed posters in advance for official approval. (Fleet Street is very particular in such matters.)

Disillusioned

Only on closer inspection did I discover that they were posters of ten months ago—pathetic voices crying in the wilderness; yet who was to know then, when the Television Committee first got broody, that we should wait another weary twelve months before even the rawest tests began, while France—of all countries—established a regular high definition service with public television receivers available all over Paris?

Rosy Atmosphere

Just why the B.B.C. sports these old posters is a bit of a mystery. Perhaps the intention is a sly Nig at the Press for over-precipitancy, though I like to think that the real idea is to create a rosy atmosphere of "getting things done," to culti-

vate the feeling that television is already a concrete fact instead of a rather irritating abstraction.

Television Bus Service

True, some high definition work is being done in the matter of a time-table for the B.B.C.'s new fleet of buses which will ply between Broadcasting House and the Alexandra Palace. Already there is a regular service between headquarters and Maida Vale, but the Alexandra Palace vehicles will probably have to be more luxurious affairs than the Maida Vale stock.

Making Up En Route

It is being suggested that each bus should incorporate a miniature green room, with make-up facilities, mirrors, etc., so that artists would be ready to "do their stuff" immediately on arrival at the Palace.

An Idea

One ingenious individual suggests that there should be an ultra-short wave link between bus and Palace; a television studio and transmitter could then be incorporated in the vehicle enabling programmes to be sent out during the bus journey.

Artists would merely alight at the Palace to receive their pay envelopes.

Date of Ullswater Report

THE first hint as to the date on which the Ullswater Report may be published has just reached me. It had been hoped that Sir John Reith might grant a "mass interview" to the

Press about the middle of January, but if, as is expected, the Report has been made public by then, the Director-General will—quite rightly, I think—decline to be heckled pending a full discussion of the Report in Parliament.

Mid. Reg. Heard in Australia

THE Droitwich Spa seems to be having a tonic effect on the Midland Regional transmitter since it was transferred from Daventry. A few days ago a listener in Victoria, Australia, reported that he had picked up the Midland programme on October 12, 1935, between 6 and 6.45 p.m. Programme details forwarded by the correspondent confirmed the reception.

Beware of the Dog

THE B.B.C. may find itself landed with a heavy bill for damages arising out of the forthcoming Christmas Day broadcast from Cape Town. I hear that the family whose party is to be broadcast will bring their dog to the microphone and offer him a tit-bit in the hope of making him bark. The idea is that he shall be the first dog to bark round the Empire.

Damages

Very pretty, but how many people remember an incident reported from Marseilles two or three months ago? A canine actor growled in a radio play, with the result that the dog belonging to a listener flew at the radio set and smashed it beyond repair. When the listener brought an action against the broadcasting company, the Court awarded him substantial damages.

Explanation from Palestine

IT is being asked why the new Palestine Broadcasting Company is not taking a leading part in the Christmas Day broadcast of the Bells of Bethlehem. Actually, the relay is being handled by the Department of Posts and Telegraphs.

The answer is simply that the P.B.C. is in a very raw state. Mr. R. A. Rendall, the B.B.C. emissary who is acting as organiser, has a good deal of uphill work ahead before service can get beyond the Writtle stage.

Colonial Broadcasting

Quite a number of British Colonies and smaller possessions

now have broadcasting services of their own, as distinct from relay services. The most recently opened was at Fiji. The others are Hong Kong, Ceylon, Kenya, Trinidad, and Mauritius.

The Relays

Relay services, in which a central short-wave receiver lades out overseas programmes to listeners in the district, are installed in Nigeria, Sierra Leone, the Gold Coast, the Falkland Islands, Gibraltar, the Barbados, Malta, and Lagos. The Lagos service was opened only a fortnight ago by the Rt. Hon. J. H. Thomas, in a message broadcast from Daventry.

Blind Radio Playwrights

NO one seems to have considered until now that a blind person should be, of all people, the best suited to write an effective radio play. Forced by circumstances to extract the maximum amount of "awareness" from sounds, the blind man should be able to put himself in the shoes of the listener to a radio play more successfully than the man to whom listening is normally only of secondary importance.

The blind themselves are now apparently recognising this fact.

A Braille Guide

Recently the National Institute for the Blind issued a Braille edition of Mr. Val Gielgud's book, "How to Write Broadcast Plays." Within a few days of publication the whole edition was sold out, many orders coming from the Dominions and America.

The demand continues, and the Institute has now produced a cheaper edition in paper covers.

"This is the I.S.B.S."

THE B.B.C. is the envy of a good many broadcasting organisations on account of its initials, which even the worst stutterer can manage without the slightest difficulty. Less fortunate is the Indian State Broadcasting Service, which is finding I.S.B.S. an awkward mouthful, especially with microphones with a tendency to stress sibilants.

A move is now afoot to change the name of the service to All-India Radio, so it will soon be a pleasure to be "on the A.I.R."

Random Radiations

Who's Responsible ?

A VERY curious position arose in Parliament when a Member wished to put a question concerning the alleged advertising of foreign business concerns in a broadcast talk. Mr. Speaker refused to accept the question, saying that it did not come within the province of any Minister. Actually the Postmaster-General is responsible for the issue of wireless licences and the collection of the fees paid for them. He also approves of the sites selected for B.B.C. stations and so on. But he has nothing whatever to do with the programme side of the B.B.C., and as matters are at present there is no Minister who has. This is a matter which will probably be rectified by the Ullswater Commit-

tee's report when it appears. It is expected that the Lord President of the Council will eventually become responsible for keeping an eye on the programmes broadcast.

What of Television ?

SOMETIMES I wonder how television will "go" in this country once a start has been made with the high-definition service from the Alexandra Park. Frankly, I don't expect anything like a repetition of the boom that took place in wireless when 2LO, Britain's first broadcasting station, was opened. The history of wireless has been one of rapid and regular progress. Though there was some difficulty about obtaining receiving licences in the first few years after

By "DIALLIST"

the war, there were a good many sets in use in the pre-broadcasting days. Heaps of people had had a foretaste of broadcasting from the Eiffel Tower and from amateur and unofficial transmissions in this country. Further, receiving sets were comparatively easy to make (probably at least eighty per cent. of them were home-made in those days), and you could construct something quite useful for between ten pounds and twenty pounds. The story of television has been very different. The public has been led many and many a time to believe that television was an accomplished fact, only to find that it wasn't. More than seven years ago now we were assured that we were on the verge of being able to see Test Matches in progress at Sydney.

Slow but Sure

No one who witnessed high-definition television demonstrations in the spring of 1934 could doubt that real television was then possible. A good deal was written about it in the papers—but nothing much seemed to happen. Then came the Television Committee's report, and once more it appeared that it would not be long before a start was made. But a long time has elapsed since the publication of that report, and I am afraid that owing to these ups and downs, these false starts and delays, the man in the street has lost his first fine enthusiasm to some extent. Then, to begin with, at any rate, the viewing apparatus will be costly. The only possible homes in which the television receiver can be used are those within a twenty-five miles radius of London. I expect, then, to see television coming rather slowly into popular favour, though interest will be considerably stimulated by the viewing centres that the B.B.C. proposes to erect in some parts of London. A great deal will depend upon the programmes provided and the speed with which the regular service is brought into operation.

Broadcast to Kidnappers

DID you, I wonder, hear the message which was sent out from all French Government stations on behalf of Professor Malmejac, whose small son had been kidnapped a day or two before? It ran: "50,000 francs will be paid without question if you return Claude to his parents. You have the word of Professor Malmejac." The S.O.S. was sent out by order of M. Mandel, the Minister of Posts and Telegraphs, to whom the Professor had appealed. The French law on such matters must be very different from our own, for it is, I believe, illegal to advertise (and advertising presumably includes broadcasting) that a reward will be paid without question for the return of stolen property—stolen property no doubt including kidnapped children. Or, is it permissible to say, "napped kids"? I find by reference to my dictionary that the "nap" is really "nab," meaning, of course, to catch or seize. Our own law must be comparatively recent, for I have some old newspapers published in the Seventeen-Fifties which contain quite a few advertisements offering rewards, with no questions asked, for the return of this or that.

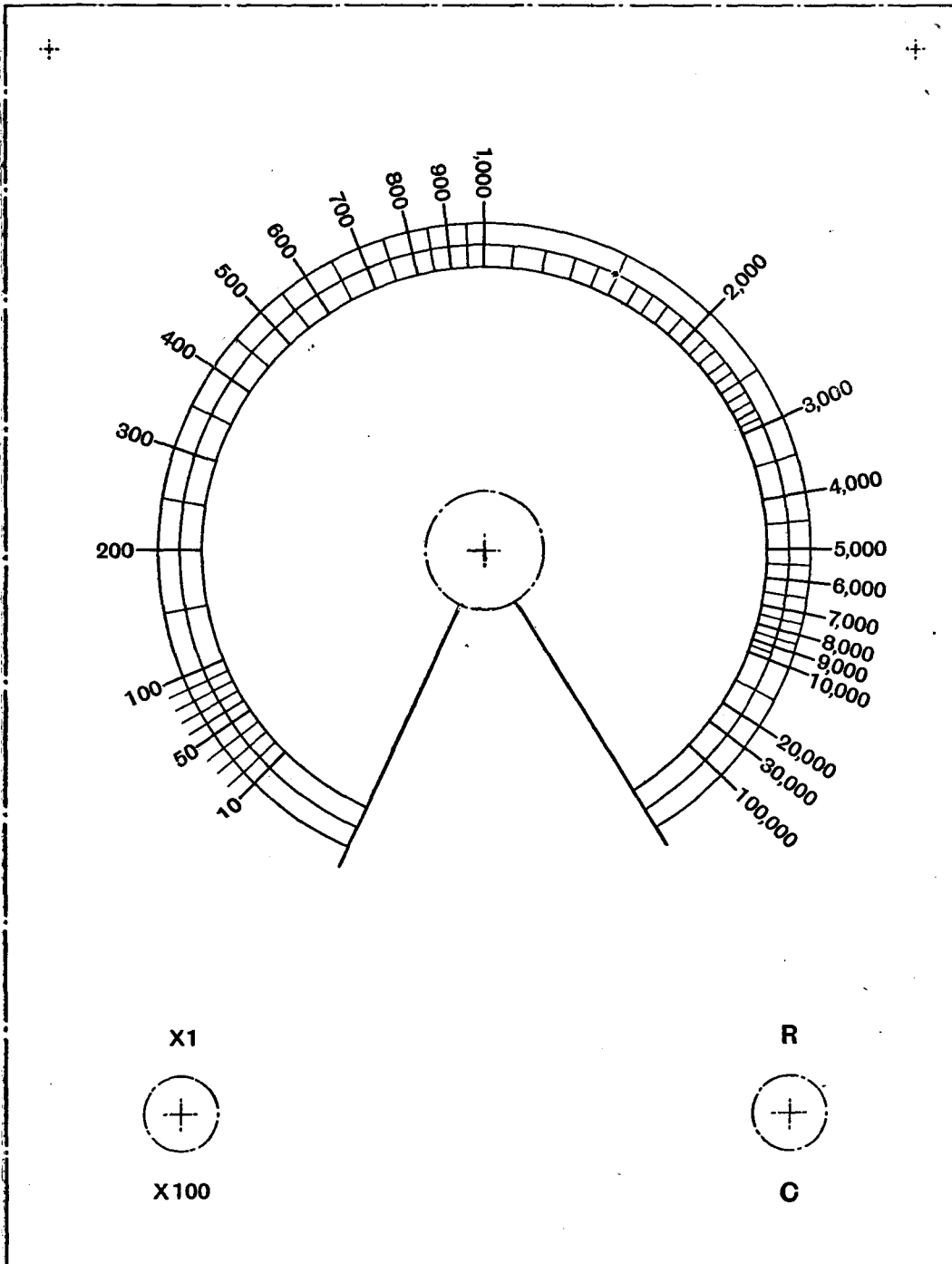

The calibrated scale for the Resistance and Capacity Bridge described in this issue. The scale should be cut along the dotted lines and pasted on the panel of the bridge

Readers' Problems

For Purposes of Illustration

IT appears that two or three readers have been inadvertently misled by published photographs of the 1936 Monodial Receiver in which a small front panel was shown. This panel was fitted to the receiver purely for purposes of illustration; as a rule it will not be required, as in normal circumstances the front of the cabinet in which the receiver is housed will form the panel.

Avoiding AC Leakage

A CORRESPONDENT who is about to fit a plain two-condenser anti-interference filter at the point of entry of his AC mains supply has been advised to connect the condensers as shown in the right-hand side of Fig. 1. This differs from the usual method of connection, and is recommended in order that the amount of leakage current from the "live" mains to earth may be greatly reduced.

After considering the matter, our correspondent is at a loss to see how this form of connection can result in any appreciable

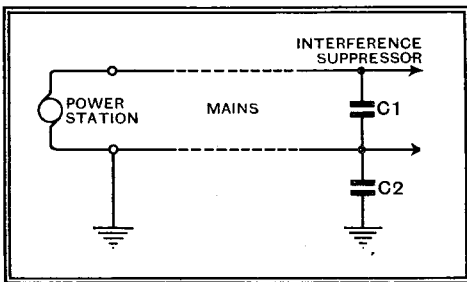

Showing why an anti-interference filter connected in the manner now approved for AC mains avoids earth leakage troubles.

reduction of leakage; it appears to him that, in effect, the two condensers are wired in series between the "live" main and earth, and consequently leakage current should apparently amount to that which would normally flow through a capacity equal to half that of the individual condensers.

There is a good deal of excuse for looking at the problem in this light, but if we redraw the pertinent parts of the whole circuit as in Fig. 1, the actual position will be clear. It will be seen that the leakage current flowing to earth through C2 is equal, not to the full main voltage, but merely to the voltage drop along the earthed main lead.

Frame-aerial Windings

STRICTLY speaking, the inductance value of a frame-aerial winding should be calculable as accurately as that of an ordinary tuning coil. But, when the frame is built into a portable receiver, it at once comes into proximity with a number of metal components and other miscellaneous ironmongery, with the result that its inductance is affected appreciably—and usually to an extent that cannot be accurately estimated. Final adjustment must almost always be made by trial and error.

For example, we are quite unable to specify the precise winding required by a constructor who is following a published design, in so far as the circuit is concerned, but is making alterations to the size of the container and to the internal layout. As the frame is to be slightly larger, the simplest thing to do is to put on the specified windings and then to remove turns, one by one, until the right value is reached. There should be no difficulty in that.

The Variable Selectivity IV.

SEVERAL prospective constructors of the Variable Selectivity IV ask whether there is any objection to using a permanent-magnet loud speaker instead of the energised model specified.

This is quite permissible, and the only alteration involved in the circuit will be the connection of a so-called "speaker field replacement choke" of 2,500 ohms resistance in the position originally occupied by the speaker field winding.

Distant Loud Speakers

WE are asked to say whether there is any objection to mounting a moving-coil loud speaker (which derives its field energising current from the HT supply system) at a distance of some 30 feet from the set; in the event of this being permissible, is it necessary to separate the field wires from the speech current leads?

In normal circumstances there is no objection to this course, except on the general principle that wandering HT leads are rather unsafe; it is unnecessary to separate the connecting wires. As a rule, it is advisable that the extension leads should be connected to the output transformer primary, which means, of course, that the transformer will be mounted on the loud speaker in the normal manner.

Impedance Measurement

A READER who is none too well provided with measuring instruments asks how he can ascertain the impedance of a small LF choke at a given frequency.

Assuming that a source of constant AC of the desired frequency is available and that measurement of DC resistance can be

The Wireless World INFORMATION BUREAU

THE service is intended primarily for readers meeting with difficulties in connection with receivers described in *The Wireless World*, or those of commercial design which from time to time are reviewed in the pages of *The Wireless World*. Every endeavour will be made to deal with queries on all wireless matters, provided that they are of such a nature that they can be dealt with satisfactorily in a letter.

Communications should be by letter to *The Wireless World* Information Bureau, Dorset House, Stamford Street, London, S.E.1, and must be accompanied by a remittance of 5s. to cover the cost of the service.

Personal interviews are not given by the technical staff, nor can technical enquiries be dealt with by telephone.

THESE columns are reserved for the publication of matter of general interest arising out of problems submitted by our readers. Readers requiring an individual reply to their technical questions by post are referred to "The Wireless World" Information Bureau, of which brief particulars, with the fee charged, are to be found at the foot of this page.

made, it should be easy to ascertain the impedance value with reasonable accuracy. The procedure suggested is as follows:—

Join the choke in series with a variable resistance and connect the two across the source of AC; then connect a valve voltmeter across the resistance and inductance in turn, adjusting the resistance until the reading of the voltmeter is the same in either position. The impedance is now equal to the value of the resistance.

For this purpose the valve voltmeter need not be calibrated, as absolute measurements are not required. It may consist of nothing more than an anode-bend rectifier valve with a meter in its anode circuit and a large by-pass condenser between anode and cathode.

Valve Base Connections

TWO or three correspondents have noticed that in the theoretical circuit diagram of the Short-Wave Two (*The Wireless World*, November 15th) the numbering of the TP22 valve connections do not correspond with those appropriate for that type of valve as shown in our recent Valve Data Supplement.

It should, therefore, be pointed out that the numbering of the diagram in question corresponds with the terminal numbering of the particular make of valve holder specified for the receiver.

Varley IF Transformers

IN a recently published reply to a query dealing with variable-selectivity IF transformers, we inadvertently omitted to

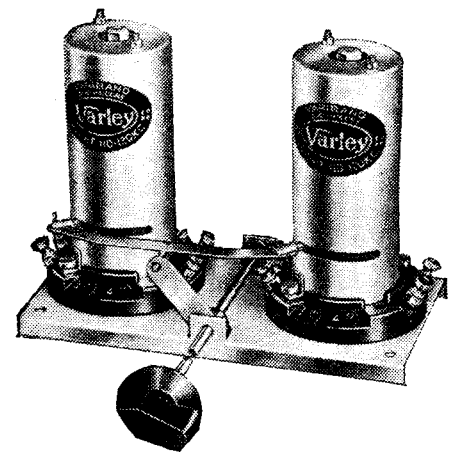

The Varley variable-selectivity IF coupling is designed for 110 kc/s superhets.

refer to the fact that the Varley "Vari-band" IF transformer complies with the requirements expressed by our querist. The unit, which comprises two IF transformers with control of coupling operated by means of a knob mounted on the panel, is designed for operation at a frequency of 110 kc/s.

Recent Inventions

The following abstracts are prepared with the permission of the Controller of H.M. Stationery Office, from Specifications obtainable at the Patent Office, 25, Southampton Buildings, London, W.C.2, price 1/- each

Brief descriptions of the more interesting radio devices and improvements issued as patents will be included in this section

CATHODE RAY TUBES

IN a cathode ray television receiver of the "hard" type the control and focusing electrodes are designed to ensure that increases of potential on the decelerator, in the negative sense relatively to the cathode, produce an increase of the current flowing to the accelerator electrode. In the drawing the first accelerator is marked *A*, the decelerator *D*, and the second

comparable with the tuning capacity of the main oscillatory circuit, and may, in fact, constitute the greater part of it, so that in practice it is difficult to obtain a grid-excitation voltage of sufficient amplitude and correct phase. This difficulty is emphasised in the case of valves having a high mutual conductance or a large grid-cathode capacity.

According to the invention, in a

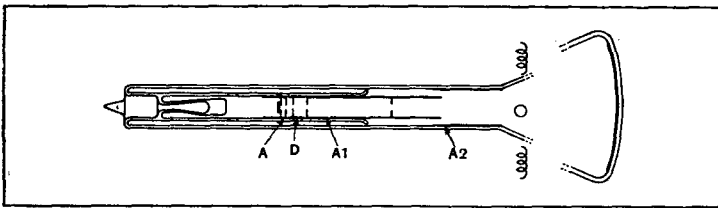

Details of cathode ray tube design.

accelerator *A1*. The decelerator *D* is used as the modulating electrode, whilst *A1* takes the place of what is usually called the first anode. The electrodes are mounted as a sliding fit inside a glass tube, the end of the electrode *A1* projecting, as shown, for some distance beyond the end. A second anode *A2* slightly overlaps the ends of the anode *A1*. The anode *A1* carries a positive voltage of 1,000, and *A2* a voltage of 3,600, whilst the decelerator *D* is biased 20 volts negative with respect to the cathode.

Patent issued to *Electric and Musical Industries, Ltd.*; *I. Shoenberg*; and *W. F. Tedham*. Application dates 3rd October, 1933, and 17th July, 1934, No. 431327.

SHORT-WAVE OSCILLATORS

FOR wavelengths below 10 metres the inter-electrode capacity of the generating-valve is

three-point coupled valve-oscillator the grid and cathode electrodes are connected to a pair of Lecher wires. These are bridged by a condenser and resistance to form an impedance which, in combination with the grid-cathode capacity, is made resonant to the main oscillatory circuit. The arrangement increases the impedance of the grid-cathode circuit at the working frequency, and thereby cuts down short-circuit losses.

Patent issued to *General Electric Co., Ltd.*; *J. Bell*; *L. J. Greentree*; and *E. C. S. Megaw*. Application dates 17th April and 1st June, 1934. No. 431599.

VARIABLE-SELECTIVITY CIRCUITS

THE intermediate-frequency stages of a superhet receiver comprise two parallel channels *A*, *B*, the circuits of one being more

sharply tuned than those of the other. The "gain" of the two channels is differentially controlled, in accordance with the strength of the incoming signals, by the AVC rectifiers *A1*, *B1*, so that the selectivity of the set as a whole is made to correspond closely with that of the more selective channel as signal strength falls off, and vice versa. With a weak signal input, the sharply tuned channel operates with maximum gain, whilst the broadly tuned one gives minimum gain, the position being reversed as signal strength increases. This serves to ensure a high-fidelity response to all signals.

Patent issued to *Marconi's Wireless Telegraph Co., Ltd.* Convention date (U.S.A.) 29th November, 1933. No. 431755.

GENERATING SHORT WAVES

ULTRA-SHORT waves are generated without using either the Barkhausen-Kurz method or a magnetron, and without direct back-coupling. The electron stream from a cathode *C* is formed into a beam by negatively biased electrodes *E*, and then passes through a hollow electrode *B* under the acceleration of grids *G*, on to a series of anodes *A*, which are preferably arranged at an angle to the stream.

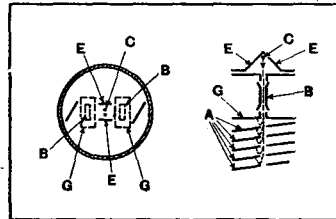

Electrodes of ultra-short wave generator.

It is stated that the electron stream as it approaches the hollow electrode acts like a negative current upon a Faraday Cage. Once it has entered the hollow electrode the current suddenly ceases, the

effect being the same as if the electrons had settled on the metal of the cage. When the stream emerges it acts as a current impulse in the opposite direction. The period of "dwell" within the cage determines the frequency of the generated oscillations, which are then fed directly to Lecher-wire radiators.

Patent issued to *O. Heil*. Convention dates (Germany), 23rd February, 1934, and 29th January, 1935, No. 431447.

"SILENT" TUNING

THE objects of the invention are (a) to simplify tuning-in to a generous selection of predetermined stations (b) to eliminate background "noise" when changing-over from one station to another, and (c) to shut out carrier-interference below a certain level of signal strength.

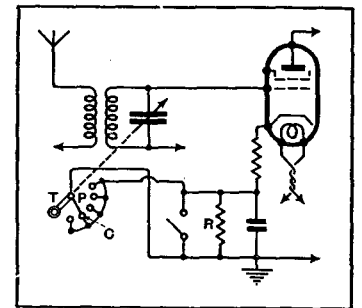

Silent tuning circuit.

As shown in the figure, the tuning control *T* carries an extra pointer *P* which, when the control is correctly set to receive one or another of the "worthwhile" stations, engages one of a corresponding number of contacts *C*, and so short-circuits a resistance *R*. At all other (interstation) settings of the control, the resistance *R* is in circuit and serves to apply a paralysing bias to one of the intermediate-frequency valves (not shown). This, in turn, prevents any low-value signals (or other "noise") from getting through to the loud speaker.

Patent issued to *Radio Frequency Laboratories Inc.* Convention date (U.S.A.) 29th September, 1933. No. 431702.

COLOUR TELEVISION

NATURAL colour effects are produced in a cathode-ray television receiver by projecting, say, three separate images on to the same number of fluorescent screens. Each of the screens is made of a fluorescent material having a characteristic colour response, such as calcium tungstate for the blue, zinc silicate for the green, and zinc phosphate for the red. The scanning of the three screens is effected in a rapid succession of alternate lines, the three pictures being finally superposed in the observer's eye through a suitable optical system.

Patent issued to *Fernseh Akt* Convention date (Germany) 6th March, 1933. No. 432989.

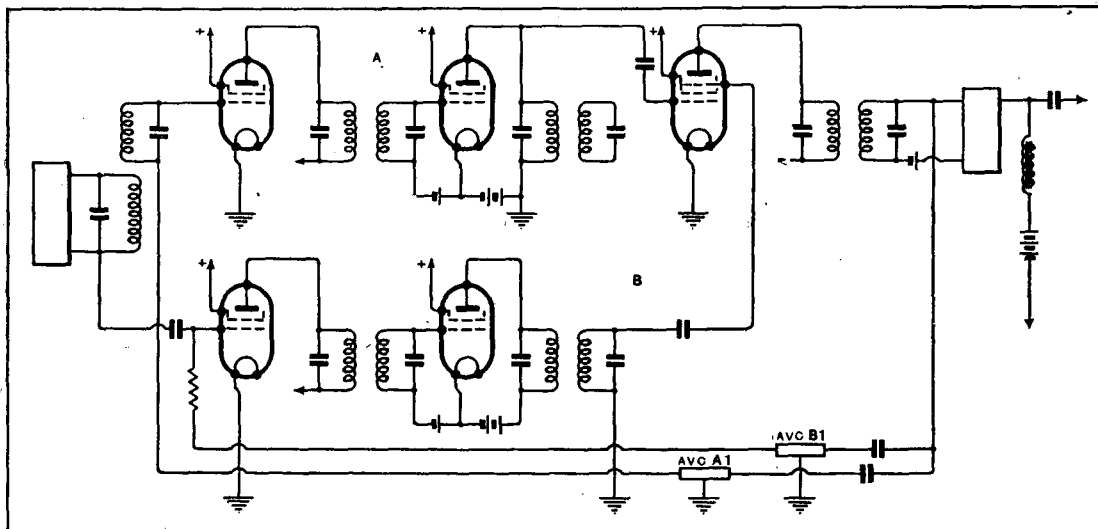

Diagram of circuit for variable selectivity.

The Wireless World

THE
PRACTICAL RADIO
JOURNAL
25th Year of Publication

No. 852.

FRIDAY, DECEMBER 27TH, 1935.

VOL. XXXVII.

No. 26.

Proprietors: ILIFFE & SONS LTD.

Editor:
HUGH S. POCOCK.

Editorial,
Advertising and Publishing Offices:
DORSET HOUSE, STAMFORD STREET,
LONDON, S.E.1.

Telephone: Waterloo 3333 (50 lines).
Telegrams: "Ethaworld, Sedist, London."

COVENTRY: Hertford Street.

Telegrams: "Autocar, Coventry."
Telephone: 5210 Coventry.

BIRMINGHAM:

Guildhall Buildings, Navigation Street, 2.
Telegrams: "Autopress, Birmingham."
Telephone: 2971 Midland (4 lines).

MANCHESTER: 260, Deansgate, 3.

Telegrams: "Iliffe, Manchester."
Telephone: Blackfriars 4112 (4 lines).

GLASGOW: 26B, Renfield Street, C.2.

Telegrams: "Iliffe, Glasgow." Telephone: Central 4857.

PUBLISHED WEEKLY. ENTERED AS SECOND
CLASS MATTER AT NEW YORK, N.Y.

Subscription Rates:

Home, £1 1s. 8d.; Canada, £1 1s. 8d.; other
countries, £1 3s. 10d. per annum.

*As many of the circuits and apparatus described in these
pages are covered by patents, readers are advised, before
making use of them, to satisfy themselves that they would
not be infringing patents.*

CONTENTS

	Page
Editorial Comment	655
The Year's Progress in Commer- cial Wireless	656
Suppressing Electrical Interference	659
Current Topics	661
Does Broadcasting Serve Britain? VII	662
Unbiased	665
Sub-Harmonics	666
Few or Many Valves	668
Short-wave Kit Set	669
Listeners' Guide for the Week ..	670
Choke Input Filters (concluded)..	672
Random Radiations	673
Letters to the Editor	674
Broadcast Brevities	676
New Apparatus Reviewed	677
Recent Inventions	678

Editorial Comment

Home Recording

Evidence of Keen Interest

WHEN we suggested in our issue of November 29th that interest in home recording had revived we had no idea that such a large volume of letters on the subject would reach us as has been the case. Letters from readers have arrived by every post since that issue appeared, and the correspondence published since has served as a further encouragement to more readers to write to us detailing their experiences.

So much interest in a subject which, it might have been thought, had died for want of support clearly indicates that there would be to-day a really big demand for equipment of this kind if it could become available at a fair price and were not too complicated to operate.

What strikes us as rather remarkable in connection with the correspondence we have received is that all the letters have come from reader enthusiasts, and not one communication has emanated from any manufacturer or firm able to meet the demand. If there is so much interest in the subject surely it should be worth the while of manufacturers to endeavour to market some suitable equipment. Those home recording outfits which have previously been on sale have mostly been condemned by users, who explain in their letters just where they failed. This information alone should provide a valuable guide to any designer in the trade who sets about to produce what would be acceptable to the public.

We hope that this indication of a really live interest in the subject will not be disregarded by manufacturers, but that we shall shortly be able to describe for the benefit of our readers new equipment incorporating those desirable features which have been discussed in letters.

We would like to thank all readers who have written in response to our invitation and described their experiences. It is not possible, of course, to give publication to all of these, but we have endeavoured to select those for publication which seem most likely to be of assistance to others experimenting in this field.

B.B.C. Programmes

Classify Broadcasts for Regular Hours

IN America, where we must admit those responsible for broadcasting have had a longer experience than in this country, the idea has caught on of broadcasting the same *type* of programme from a particular station at the same *time* each day. Some attempt to imitate this scheme would, we think, find favour with listeners here. We might, for instance, have a concert of serious music every Thursday evening from 8 to 10 o'clock and light music on Friday at those hours. We could look forward to Wednesday evening for plays of a serious character and light opera on Tuesdays. Talks on travel or some allied subject could be a Monday item, and domestic talks on some other day, but again at regular hours on specified days of the week. We know that this practice is adopted by the B.B.C. at present, but to a very small extent, and undoubtedly there would seem to be room to expand the scheme to the benefit and convenience of listeners in general.

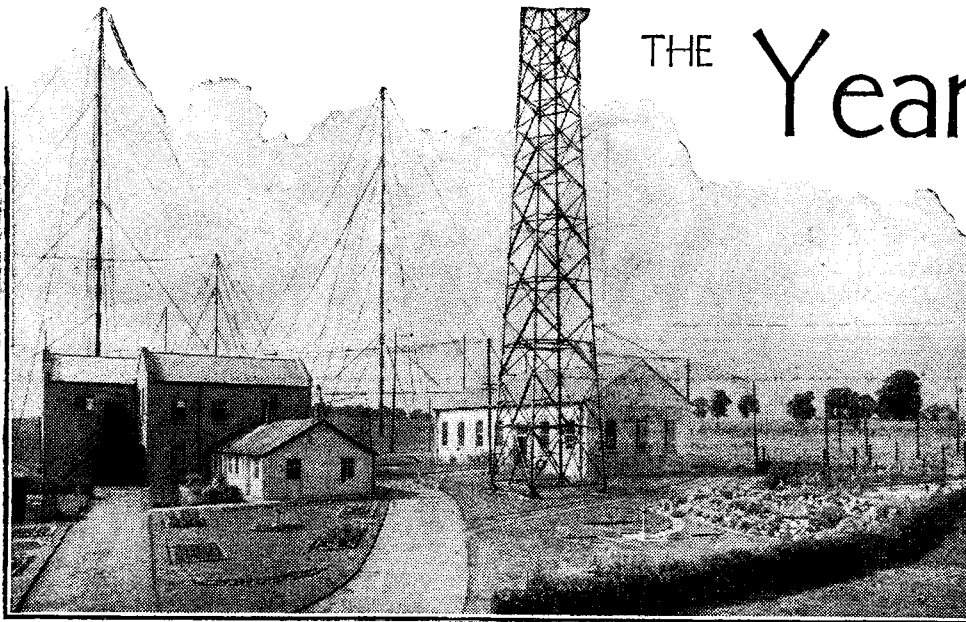

The Post Office station at Leafield, near Oxford. Both long- and short-wave transmissions are used to work different European countries.

PROGRESS in commercial wireless this year has been steady, judging from the returns of traffic, but in recording events of the year our contributor shows that there have been fewer instances than usual of what might be called spectacular advances.

ON the whole the progress made in the mobile services has been more striking than that in the fixed services, a reversal of the position in recent years which were conspicuous for the rapid development of long-range communication by short waves, for both telephone and telegraph circuits. The marine part of the mobile services has had, of course, a long start of long-range fixed services, so it was only fair that, for the last few years, the latter should have carried off the palm of progress. The demand for new point-to-point circuits has now naturally declined, and during this year progress, or rather expansion, has eased up to a marked extent.

In February there was an interesting example of a new use for long-range telephony in what was described as "the first radio-telephonic luncheon." This consisted of an interchange of speeches during a luncheon at the Hyde Park Hotel between members of the Overseas League and members of the Imperial Press Conference, who happened to be visiting the wireless station at Klipheval, in South Africa. The speeches, too, were broadcast in this country by the B.B.C., and the King sent a message to both gatherings expressing the hope that "the great discoveries which have been made in radio-telephony will still

further strengthen friendly co-operation and understanding between the nations of the British Empire.

In March, a direct radio-telephone service was opened between this country and Japan. At this end, as in other overseas telephone services, transmission is from Rugby, and reception at Baldock, the links being combined and controlled at Faraday Building, in London, before extension to the London International Telephone Exchange; in Japan, transmission is from Nazaki and reception at Komoru, both within fifty miles of Tokio, where the control centre and exchange are situated. The charge for this service is £2 a minute, with a minimum of three minutes. In opening this circuit the Postmaster General remarked that there were now ten direct

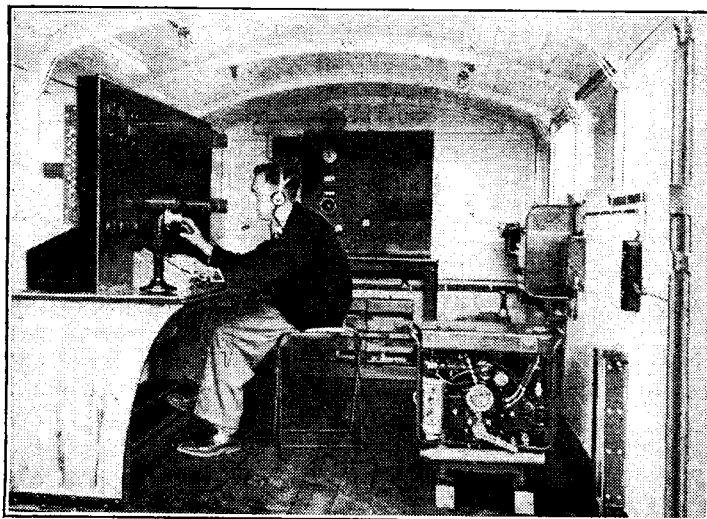

Mobile wireless station used by the Air Ministry for aircraft services at provincial aerodromes (Marconi).

radio-telephone services between this country and distant parts of the world, and

THE Year's Progress in

NOTABLE EVENTS OF 1935

By **LT.-COL. CHETWODE CRAWLEY, M.I.E.E.**

that 95 per cent. of the world's subscribers could be linked together through the London terminal.

An interesting demonstration of the possibilities of this linking service was given in April at New York, where two men in the same building conversed over a telephone circuit which went round the world. The call went by the transatlantic radio service to London, by cable to Amsterdam, by radio to Java, by radio to San Francisco, and so to New York. This is the first time that a telephone call has encircled the globe. The conversation lasted for a quarter of an hour, and speech was perfect. By New York time, it may

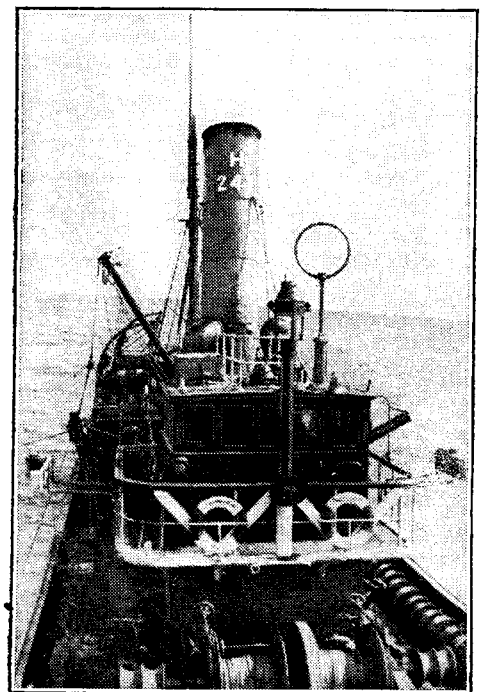

Direction-finding loop aerial on a trawler (Siemens Bros.).

be noted, the call travelled from the present into the future, then into the past, and back again to the present. It is enough to call forth the shades of Phineas Fogg.

In May, as a Jubilee concession, all Empire rates were reduced by half, from the 6th to the 31st of the month, and at the same time, as a permanent arrangement, the extra charge for the second British zone was abolished so that all parts of Great Britain, Northern Ireland and the Isle of Man are now chargeable at the same rate.

Commercial Wireless

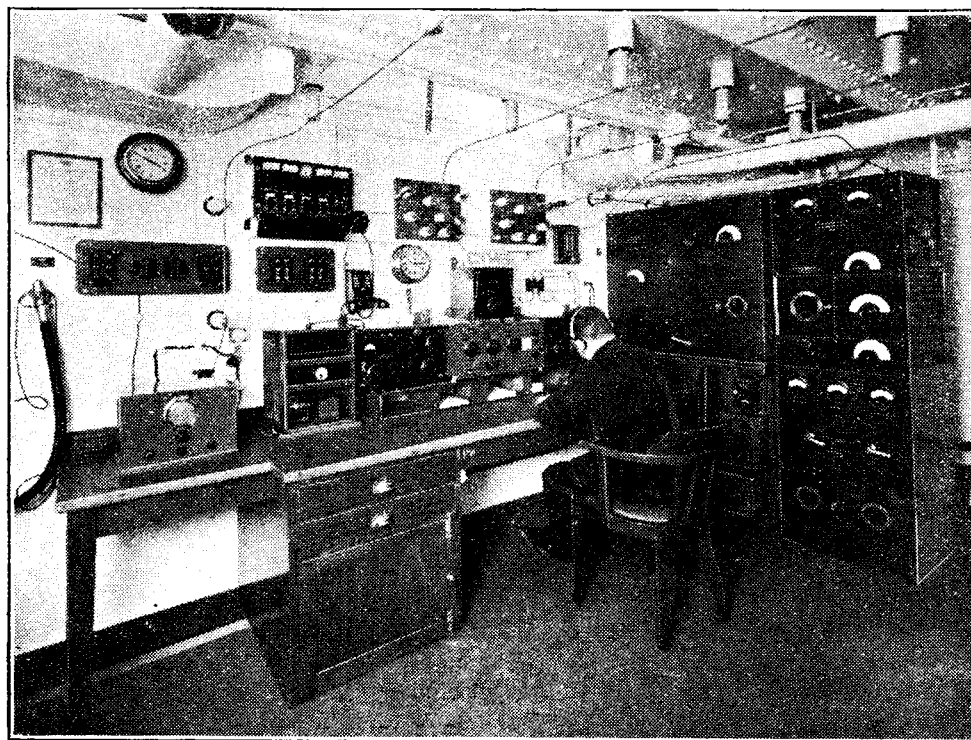

The wireless installation of the s.s. "Strathmore," launched in the summer of this year for the P. & O. Steam Navigation Co. (Marconi).

On the 1st of June permanent reductions were made in the rates for the services to Australia, New Zealand, India, South Africa and Rhodesia. For the first three the new rate is £1 10s. a minute, Monday to Friday, and £1 a minute for Saturday, the others being a few shillings more. Reduced night rates were also introduced for calls to Canada and the United States, a night call for New York being reduced to £1 8s. a minute as compared with £2 a minute during the day.

In July a service was opened with Iceland, so that the 9,000 telephone subscribers in that country can now be connected to about 34 million subscribers out of the 36 million in the directories of the world. The charge for communication with Iceland is 10s. a minute, with a minimum of three minutes.

In October a service was opened with Ceylon via the India circuit.

Short Range Telephony

Turning now to ultra short-wave circuits, some interesting advances, as might have been expected, have been made during the year. The most notable, perhaps was the opening of the Post Office circuit between Scotland and Northern Ireland. It was actually in operation under experimental conditions at the close of last year, but has been rapidly developed into a stable commercial circuit. The waves used lie between 4 and 6 metres, 12 frequencies, six in each direction, being used. Individual sending and receiving apparatus are used for each channel, the output of each transmitter

being about 5 watts. Directive rays and reflectors are employed for concentrating the waves in the required direction. The Scottish station is at Portpatrick, and the Irish one at Ballygomartin, a few miles from Belfast. Both sites are elevated so that there is an optical path between the stations, which are about 37 miles apart.

The equipments work unattended, the circuits on the Irish side terminating at Belfast, those on the Scottish side being extended to Glasgow, Liverpool and London. This is a noteworthy circuit as being the first of its kind in the world, that is to say, the first multi-channel ultra-short-wave radio-telephone link in ordinary commercial use.

Another, simpler, 5-metre telephone circuit with an automatic calling device has also been constructed and brought into operation by the Post Office between Lerwick and Walsay-Skerries, in the Shetland Islands, during this last year, and there can be little doubt that circuits of this kind will be found most useful in the future for linking up islands with one another and with the mainland.

Future Developments

Developments are, of course, taking place in the working of ultra-short and micro waves in many countries, but very few commercial services are yet in operation. It is, however, in the development of communication by these very short waves that great advances may confidently be expected during the next few years.

The rapid advance in commercial aviation during the year has naturally provided fresh impetus to the development of wireless apparatus of all sorts for aircraft communications.

Congestion on the routes between this country and the Continent has made it necessary to supplement the station at Croydon by one at Lympne, and one at Pulham. The fixing of positions is thus greatly facilitated, as well as the signalling of weather information, landing conditions, and so on. At the beginning of the

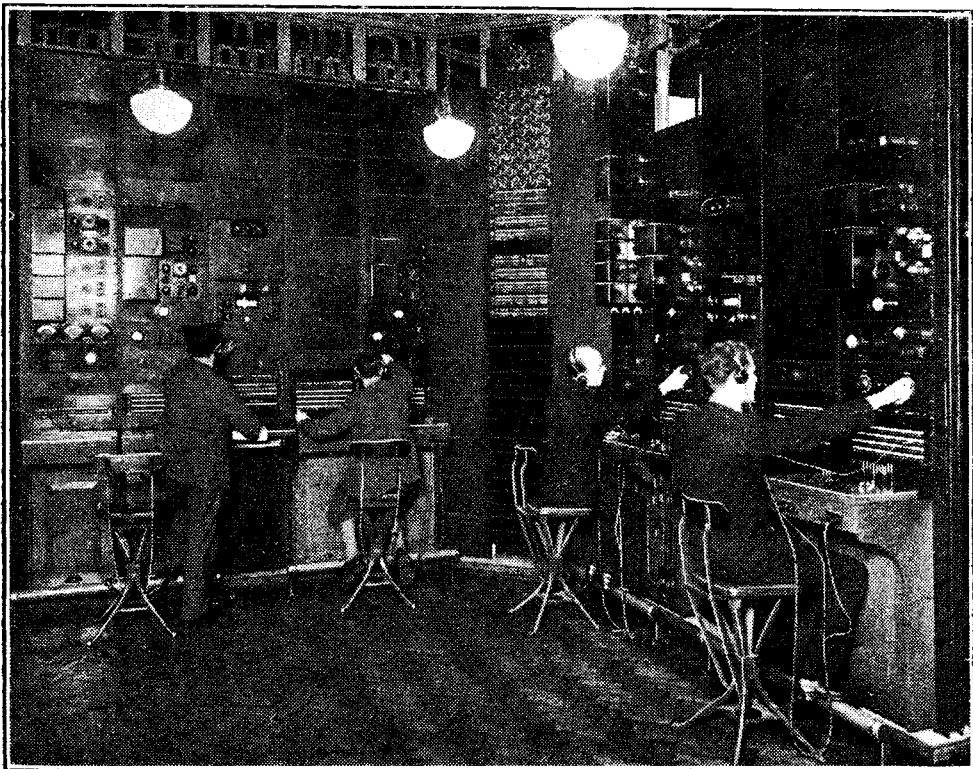

Where the G.P.O. radio-telephony messages are linked with the land line system. A corner of the terminal switchboard in London.

The Year's Progress in Commercial Wireless—year the Postmaster-General announced that, as an experiment, telegrams could be accepted at certain offices for transmission to persons travelling in Imperial Airways' craft whilst in the air between Alexandria and Karachi, and Alexandria and Capetown. During the year a start has been made in extending the system of wireless stations for the service of home air lines, most of these being, for the time, mobile stations erected on vehicles capable of easy removal so that the organisation may be rapidly adjusted as the requirements of air lines develop. A great deal of experimental work, too, has been put in hand by the Air Ministry in collaboration with the National Physical Laboratory, largely in connection with the use of short and ultra-short waves for guiding beams to assist aircraft in approaching aerodromes, and for navigational purposes generally. In June the Air Ministry announced the formation of a Signals Department (Civil Aviation) at the Croydon Airport. This Department is responsible for the erection of new wireless stations on home air routes, the technical administration of all home aeronautical wireless stations in the control of the Air Ministry, the examination of aircraft operators, and the inspection of apparatus. In June, too, an interesting demonstration was given at the Farnborough establishment of controlling a small aeroplane in flight, the Queen Bee, by wireless signals from the ground. In July the radio-meteorological work at Heston was transferred to a new station at Borough Hill, Northamptonshire, and in September a new station was brought into operation at the Bristol municipal airport.

Marine Wireless

In ship's wireless communications, as already mentioned, there has been marked progress during the year. In February an "international centre of medical radio-communication" under the honorary presidency of Marchese Marconi was formed in Rome to give medical advice to ships at sea through the Coltano station, the messages from ships being sent through that station or one of the ordinary coast stations. A medical advice service was also started from coast stations in New Zealand. Similar services are, of course, in operation in several other countries, and P.O. coast stations here have provided a service of this sort for

many years. In this connection the Applecross station in Australia provided recently what is probably a record in long-range medical advice, a Government medical officer directing the treatment for several days of a man who was in a ship 2,500 miles away.

During the year the coast stations at Portpatrick, Valentia and Malin Head were equipped with ICW apparatus in place of spark transmission, so that all the old spark equipment has now disappeared from Post Office stations. The coast station at Fishguard was closed and its activities transferred to Burnham-on-Sea Radio, where new equipment was installed. This latter station forms a part of Portishead Radio, which consists of a transmitt-

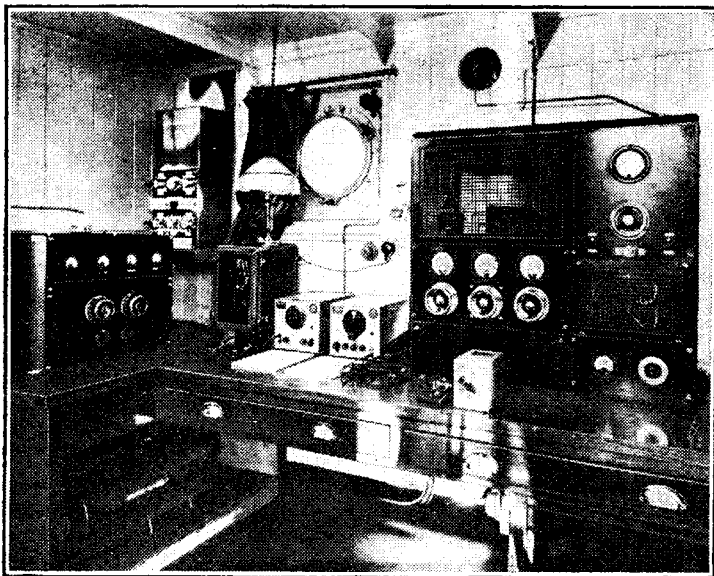

The radio installation on the m.s. "Devon City." The medium-wave transmitter is on the right and the short-wave equipment on the left. An automatic transmitting key is housed in the small box to the front of the bench (International Marine Radio Co.).

ing station at Portishead with an operating station at Burnham. At Portishead there are now seven telegraph and one telephone transmitters, and at Burnham there are thirteen telegraph and one telephone receivers. A new service of radio-telegrams *via* Portishead Radio to naval ships on foreign stations, excepting the Mediterranean, at a special rate of 7d. a word was introduced in December.

In France, a new station called St. Nazaire Radio, corresponding to Portishead Radio, was opened in May for communication with ships. The transmitting station is close to Severac, and the operating station is at Donges, 25 km. away.

All coast stations in this country are equipped with telephony for communication with small ships, in addition to telegraphy. The ships which make use of the telephone facilities are mostly fishing vessels and coasters, which, owing to their small size, are not compelled by law to carry wireless installations, but which find it useful to carry simple short-range telephone equipment that can be operated by the master or a member of the crew. This telephone signalling has developed rapidly during the last few years so that, to minimise signalling interference, it became necessary for the countries adjoining the

North Sea to come to an agreement as regards the organisation generally, including the waves to be used for communication between the ships and the shore, and between the ships themselves. Accordingly, a conference of the administrations of the countries concerned was held at Lisbon in the autumn of last year, and an arrangement for allocating waves, called the North Sea Regional Arrangement, was drawn up, and brought into force on July 1st of this year. The arrangement necessitated a change of waves for both our ships and stations, but the change-over went off smoothly, and the scheme, on the whole, is now working satisfactorily. Another conference of representatives of Baltic and northern countries was held last summer at Stockholm, to make recommendations regarding the use of radio telephony for the purpose of safety at sea, and for fixing waves for telephone communication generally in the Baltic. If the recommendations are confirmed by the countries concerned they will be put into force next year.

Safety at Sea

The International Convention for the Safety of Life at Sea, 1929, which was brought into force in 1933 by most countries, including Great Britain, was ratified by a number of additional countries during the year, and has been working satisfactorily as regards its wireless provisions. It has not yet, however, been ratified by the United States of America. This is the convention which makes it compulsory for passenger ships and all ships of 1,600 tons gross or over to be equipped with wireless telegraphy, and for all passenger ships of 5,000 tons gross or over to be equipped, in addition, with DF receiving apparatus. The former provision has been in force in this country for many years, so that as a matter of fact, owing to the slump in shipping, there are not so many British ships compulsorily equipped now as there were in 1929. On the other hand, there are three times as many small craft voluntarily fitted with wireless as there were in 1929, due mostly to the rapid growth in the number of wireless installations in fishing vessels. DF installations were not compulsory for any ships in 1929, and there are now about twice as many ships fitted as then.

One of the most interesting ship equipments of the year was that of the great French liner "Normandie." It consists of one long-wave, one medium-wave and two short-wave transmitters (one for telephony), two telegraph receivers for all waves, one receiver for Press on long waves, and one telephone receiver. All these, excepting the telephone receiver, are in the main operating room, with the power plant in an adjoining room. In addition, there is a safety station on the bridge with one telegraph transmitter (medium and long wave) and two receivers, and there are 2 DF equipments, one on the bridge for the navigating staff, and one abaft the bridge for the wireless staff.

Suppressing Electrical Interference

A RESUME of points from a paper recently read before the Institution of Post Office Electrical Engineers by Mr. J. Neale. The Post Office, which maintains a staff of 250 anti-interference specialists, is in a unique position for obtaining information on the subject, and Mr. Neale's paper was, in effect, a comprehensive survey of the present technical position.

A G.P.O. Engineer on Present-day Practice

AFTER dealing with the nature of electrical interference and the basic principles of suppression, the lecturer made it clear that interference reaching the aerial by direct radiation from its source cannot be cured by any measures taken at the listener's premises; the matter is normally one to be dealt with by the owner of the offending apparatus.

It is not surprising to learn that trams and trolley buses present great difficulties in treatment. Noises are primarily due to (1) the driving motors, (2) the controller circuits, (3) auxiliary motors, such as air compressors, (4) the collector system. Strangely enough, the familiar pyrotechnic displays due to sparking at the collector controls is not so serious as the other sources, and this part of the system is not considered to be responsible for any great proportion of the total interference. Given good maintenance of the lines, noises emanating from within the vehicle are predominant. The latest technique for suppression favours the fitting of radio-frequency filters to individual sources of interference; practically complete suppression has been demonstrated by this method.

Unfortunately, the fitting of condenser suppressors to the driving motors of trolley buses introduces the risk of shock to persons boarding the bus in the event of one of the condensers breaking down. There is also the possibility of static shocks by discharge through the condensers. Not all of us are agile enough to board the buses with a flying leap, and so these unpleasant possibilities must be taken into account! It seems probable that the possibility of condenser breakdown can be rendered sufficiently remote by using condensers of high enough test voltage in series for the frame connection, and, as an additional precaution, the connection of a resistance of suitably high value across the condenser immediately connected to the frame. This will ensure that the unshunted condenser is subjected to nearly all the electrical stress, and so it is almost certain to break down first. The leakage current passing through the resistance will reveal this fault in the daily leakage test.

It has been confirmed by experiments that by restricting the capacity of the condensers in series to 0.1 mfd. all risk of an unpleasant static shock is avoided.

Another recently developed method of suppression depends on the fitting of con-

densers between the overhead wires and earth at intervals of about seventy yards. This system is estimated to cost about £40 per route mile and has the advantage of reducing collector clicks as well as interference from within the vehicle. It is thought that the chief applications of this method, used in conjunction with other systems, will be in areas where the field strength of B.B.C. stations is low, and where the streets traversed by the trolley-bus routes are narrow, with the result that receivers are more than usually closely coupled to the overhead conductors. In such cases it has been found that metal gutters pick up interference and conduct it to the vicinity of the receiver.

Long-range Interference

Suppression of interference from electro-medical apparatus also presents unusual difficulties, as the radiation from certain apparatus may extend over distances of five miles; it interferes very seriously with reception of television and other signals on ultra-short wavelengths. The apparatus may be either redesigned to reduce earth currents to a minimum, or the treatment may be given in a room screened with wire mesh, sprayed zinc, or metallised paper.

A large number of complaints received by the Post Office deal with interference from high-tension overhead cables, which is naturally more severe in wet weather. Such complaints are usually referred to the Central Electricity Board for investigation; an improvement may sometimes be brought about by attending to the lines (by cleaning insulators, etc.), but in many cases it is not possible to overcome the trouble. However, it is understood that the C.E.B. has set up a department to deal with wireless interference and research work on insulator design, which may ultimately lead to a satisfactory remedy, is now proceeding.

Neon signs are coming into such widespread use that they are becoming a very serious source of interference, but it may be mentioned that only the red tubes are responsible. It has been found that a specially insulated 50-henry iron-cored choke inserted in series with the tubes is the most effective cure.

The Post Office recognises the need for keeping its own house in order, and claim with pride that less than 0.25 per cent. of the total complaints received are traced to G.P.O. sources. The official attitude is that a higher standard shall be maintained than is expected of outside owners of interfering plant, and the degree of suppression aimed at is not

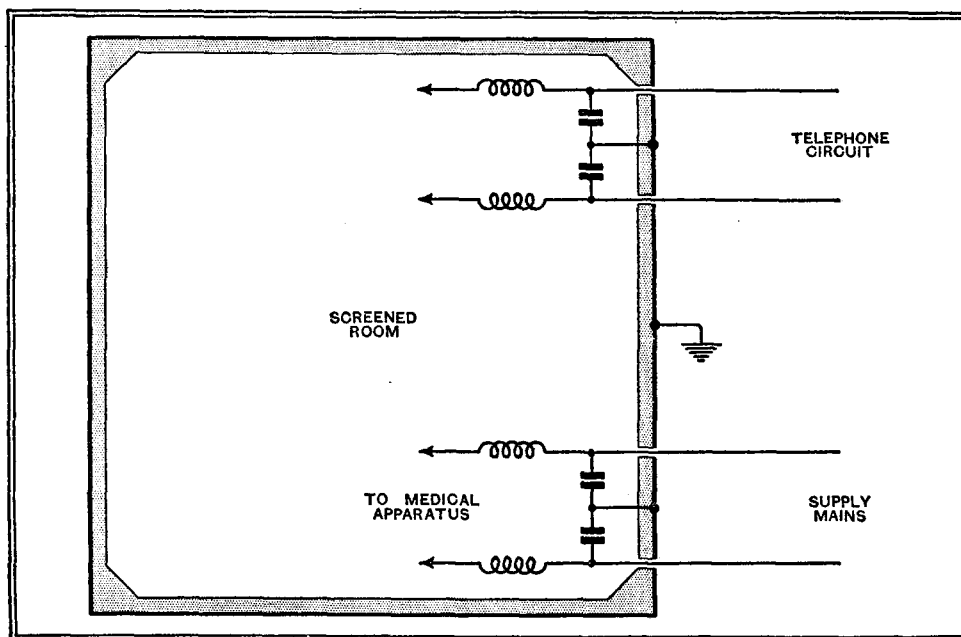

Screened room for electro-medical apparatus; note that incoming power and telephone lines are filtered to prevent the egress of interfering impulses.

Suppressing Electrical Interference—

limited to that required to permit reception of local stations.

Unit Automatic Exchanges, for instance, are often situated in rural areas where sensitive receivers are necessary,

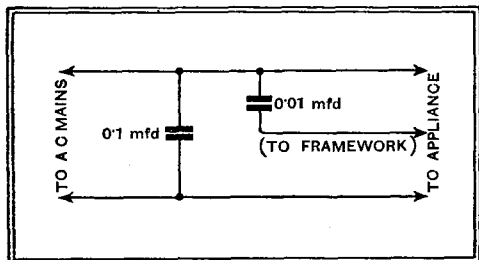

Suppressor circuit for unearthed appliances, such as vacuum cleaners, connected to AC supplies.

and so interference is caused by the numerous switches and relays in the exchange. A cure, developed by the Research Branch, makes use of a choke-condenser filter in each line leaving the exchange. Thus the radiation of interfering impulses due to every kind of apparatus in the exchange is prevented.

Troubles due to telephone subscribers' dialling apparatus occur generally when aerials run very close to a telephone route or where a subscriber's aerial lead-in is in close proximity to his own internal telephone wiring. Rearrangement of the aerial lead-in is often effective, but it sometimes becomes necessary to connect a special dial-suppressor unit, consisting of two small chokes and a tubular condenser, to the dial-impulse springs.

Complaints for which the P.O. can hardly be held ethically responsible sometimes originate through interfering currents being induced from external sources into the Department's overhead lines. Tramways, electro-medical apparatus, and charging plants are fruitful causes of such trouble. If the interference cannot be traced and cured at its source, HF chokes, mounted on special insulators, are fitted at suitable points in the lines.

Heavy-duty HF Chokes

A series of standard HF chokes, known as Inductors RF, and with current-carrying capacities of 3, 5, 15, 25, 50 and 100 amps., have been designed; these coils have suitably high impedances at both medium and long broadcast wavelengths, and carry their rated current with a generally negligible voltage drop and a temperature rise not exceeding 40° C. Inductors permanently connected to the supply mains should be enclosed in earthed metal cases in accordance with the I.E.E. regulations. Work is still proceeding on choke design.

Emphasis is laid on the extreme importance of non-inductive condensers and on the ill effects of inductance in connect-

ing leads. Where long connections are unavoidable, it is advantageous to use condensers smaller than 2 mfd., and it is believed that there is a distinct field of usefulness for condensers of 0.1, 0.25, and 1 mfd.

The use of condenser suppressors on unearthed appliances (vacuum cleaners, etc.) may have serious consequences. In spite of I.E.E. regulations the exposed metal cases of these appliances are not always earthed, and consequently there is risk of shock, either through condenser breakdown or the normal passage of AC through condensers of the conventional 2 mfd. capacity; such a shock is obtained if the user of the appliance touches the case and earth simultaneously. This difficulty is overcome by using a condenser suppressor arranged as in the accompanying diagram,

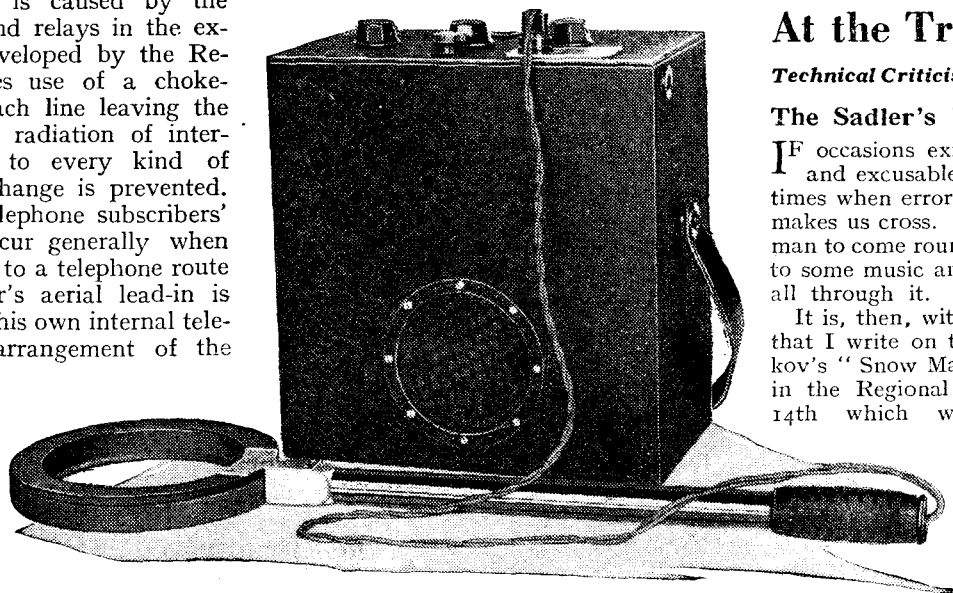

Portable equipment for interference detection, as used by Post Office investigators.

and at the same time by restricting the condenser connected to the frame to a value of 0.01 mfd. The current passed by such a condenser at normal AC voltages is below the limit of sensibility to shock. Unfortunately, suppression afforded by such small condensers is not always sufficient, and it may be necessary to add chokes which would not be required if larger condensers could be used. It is, therefore, better and more economical to earth the body of the appliance.

Both in Mr. Neale's paper and in the subsequent discussion (in which P.O. officials took part), it was made clear that the Department cannot officially concern itself with the suppression of interference which affects only distant stations or short-wave transmissions. But, so far as the short-waves are concerned, this attitude will probably be modified when the British television service comes into being.

The Wireless Engineer**An Appreciation from America**

IN the November issue of the *Review of Scientific Instruments*, published by the American Institute of Physics, there appeared an article entitled "A Study of

Scientific Periodicals." This paper was released for publication by the Navy Department, on whose instructions it was presumably compiled. The importance of periodicals covering various scientific fields was compared in terms of the frequency of references to original articles in them in other periodicals in their class.

In the section devoted to radio periodicals of the world *The Wireless Engineer* was placed third on the list. In addition, it was stated in the article that the valuable abstracts in *The Wireless Engineer* would alone make that journal indispensable for radio research.

Those who propose to take *The Wireless Engineer* would do well to place a subscription now to begin with the January number, the first of a new volume. Subscription order forms can be obtained from the publishers of *The Wireless World*.

At the Transmitting End**Technical Criticisms of Recent Programmes****The Sadler's Wells Mystery**

IF occasions exist when it is both human and excusable to err, then there are also times when error is inadmissible and merely makes us cross. As, for instance, inviting a man to come round for an evening's listening to some music and then have him talk hard all through it.

It is, then, with no sort of mixed feelings that I write on the relay of Rimsky-Korsakov's "Snow Maiden" from Sadler's Wells in the Regional programme on December 14th which was equally exasperating

by reason of the appalling rumblings, apparently of heavy feet, which constantly intruded and completely spoilt an otherwise good broadcast.

One learns by experience that it is not always possible to put microphones just where they should be, and even the B.B.C. probably encounter this difficulty from time to time, but in these enlightened days, when the art of camouflage is so highly developed and microphones can be made to look like anything *but* microphones, it surely would have been possible to find a place for them which was not quite so near the stage.

The policy of taking the microphone abroad to give us the opportunity of hearing things we otherwise would not hear can only be applauded, but, in the case of musical subjects, unless more care is taken to eliminate these often elementary defects, the effort is largely wasted and we turn in despair to the alternative studio programme where the quality will be good if the material is not so much to our liking.

In those cases where conditions make good quality impossible, little purpose is served by the relay.

H. C. H.

The Practical Electrician's Pocket Book, 1936. Containing information and data covering all branches of electrical engineering, including chapters on Principles, Electrical Machinery, Wiring, Power and Domestic Applications, etc. A list of supply voltages throughout the United Kingdom occupies nearly eighty pages. Pp. 598 with numerous illustrations and diagrams. Published by "Electrical Trading," 20, Bedford Street, London, W.C.2. Price 2s. 6d. nett.

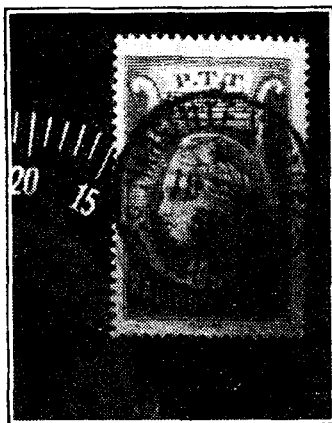

"LICENCE FEE PAID."
Every French wireless set must now carry an official stamp as above, indicating that its owner has a receiving licence.

Certificates for Aerials

A DECREE published in Marseilles ordains that all receiving aerials must be fitted with earthing devices and certified as safe by officers of the local fire brigade.

Television on Tap ?

THE first completed building in London to be equipped with TELEVISION facilities with central aerial system," ran an advertisement last week for new flats erected in the Mayfair district.

Brasov Mystery

ROUMANIAN listeners are growing impatient over the long delay in the opening of transmissions from the new 150-kW transmitter at Brasov. Tests are reported on 1,875 metres, but as the station was virtually completed in July last listeners contend that the time has come for actual programmes.

Five Metres to U.S. ?

WILL it ever be possible to communicate with America on five metres? Tests are being carried out by Mr W Johnson, G2IN, of Southport, a well-known worker on this wavelength, to see if such long-distance communication is possible. He will be transmitting on 5 metres from 0900 to 1600 GMT on January 26th, and is particularly anxious for distant short-wave listeners to keep watch for him then.

Another 10-metre Contest

THE tremendous success of their first world-wide 10-metre contest (readers of *The Wireless World* will realise the remarkable renaissance of this band during 1935) has encouraged the Radio Society of Great Britain to organise a second one on this intriguing waveband. It will be held during the whole of 1936, and offers short-wave enthusiasts something completely out of the rut on which to try their skill.

Current Topics

Events of the Week in Brief Review

Moscow's Changed Wavelength

AT the request of listeners, the midnight short-wave broadcasts from Moscow will in future be given on 50 metres, not 25 as previously. The programmes are also relayed on 1,724 metres.

Television and Violin Playing

A WELL-KNOWN Parisian violinist who was recently televised at the Eiffel Tower transmitter has stated that this was his first and last appearance on the television screen. Ap-

parently, in spite of the elaborate cooling system, the heat from the 5-kilowatt arc lights put the instrument out of tune. Subsequently, it was found to have developed cracks. Wanted: Aluminium violins.

Taxi Radio Troubles

HAVING lost the first bloom of youth, the sets installed in French taxis are reported to be giving trouble. According to our Paris correspondent, three out of every four sets are either out of commission or giving unreliable service, although—as one journal points out—the taximeters are always in perfect order.

HAVE YOU GOT YOUR "WIRELESS WORLD" DIARY FOR 1936 ?

76 pages of facts, formulae and general radio information are added to the usual pages—one week at an opening—and the whole forms an indispensable pocket companion for the keen amateur.

Valve data, valve base connections, 14 pages of circuits, and an "all-wave" broadcasting guide are among the features arranged for instant reference. Price 1/6 of all stationers and booksellers, or 1/7 post free from the Publishers, Iliffe & Sons Ltd., Dorset House, Stamford Street, London, S.E.1.

The Longer Short Waves

WITH the remarkable feats of long-distance transmission being performed on the 10-metre band co-incident with the sunspot cycle, it was thought

Ecko Service Centre

CABINETS, valves, and small components originally produced for sets of 1925, and even earlier, are stored away for replacement use in the new Ecko Service Centre which was opened at Southend-on-Sea last week. It has dealers' training quarters and soundproof testing cabins.

A Wireless World

ACCORDING to figures compiled by the U.S. Bureau of Foreign and Domestic Commerce (quoted by the Daily Telegraph) there are 56,221,784 radio receiving sets in the world. North America's total is given as 25,632,881, the vast majority of these being in the United States.

Europe has 22,897,981 sets, Asia 2,553,396, South America 1,088,374, and Africa 209,201. Japan has 2,190,040 of Asia's receivers.

More Power from Brussels

THE Brussels broadcasting stations are to be raised in power from 15 to 100 kilowatts.

Television in Factories

A NEW use has been found for television in an Amsterdam factory, according to the *Germania Review*. Fitted in the manager's office are a number of television screens linked with the various departments. On pressing a switch, the manager can see and hear what is going on in any part of the building.

Details are lacking as to the system employed and the amount of definition.

Broadcasting from a Ship

THE Australian liner *Kanimbla*, which was launched at Belfast on December 12th, will be the first vessel to receive a licence from the Australian Government for the broadcasting of concerts. As proof of the speed with which Australian broadcasting affairs are conducted, it is worth noting that although the vessel has only just left the stocks a woman announcer has already been appointed.

Across the Frontier

A VIENNA Conference recently passed a resolution condemning the practice of charging duty on car radio sets when automobiles are driven from one country to another on

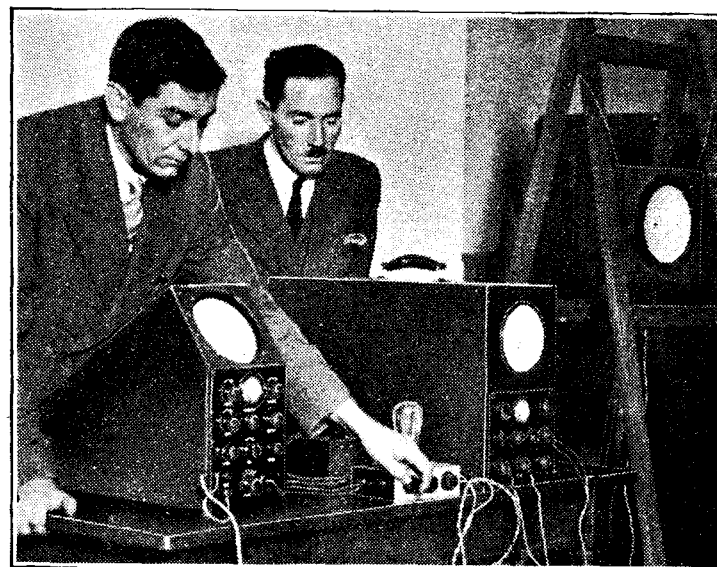

THE TUBE OF THE FUTURE. Mr. G. Parr, of the Edison Swan Company, demonstrating the latest cathode ray tubes to service men in Glasgow.

by amateur experimenters that the longer bands would prove useless. Evidence to the contrary has arisen with several British amateur contacts with Australia on the "long" short-wave band of 80 metres. To decide whether they were freak contacts or not, efforts will be made to repeat them during special 80-metre tests between January 18-26th.

Electric Guide

VISITORS to the Franklyn Institute in Philadelphia cut a ray on entering, actuating a photo-electric cell relay which sets an automatic guide into operation. This robot, dressed in official uniform, raises his right hand to point the way to the different rooms, while a loud-speaker concealed in his chest describes the exhibits.

Does Broadcasting

The architecture of the Burghead transmitter "is rather heavily Scottish . . . a startling change from the accustomed style of B.B.C. building."

A REGIONAL TOUR OF INVESTIGATION

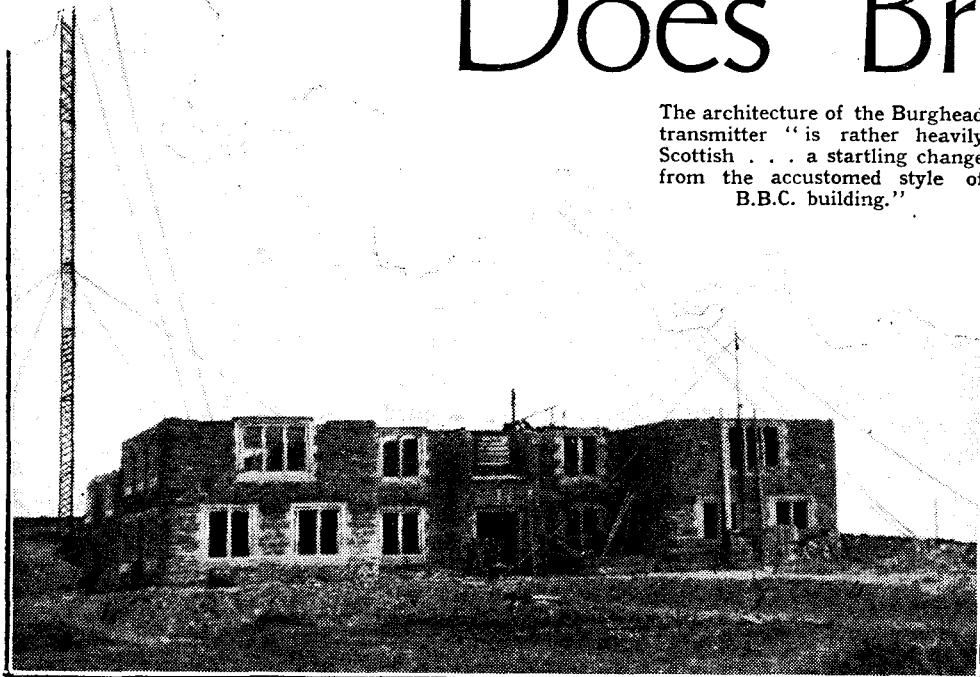

VII. — Burghead and Aberdeen

NORTH Scottish Regional will be a transmitter of 60 kilowatts, possibly synchronised on the Scottish Regional wavelength (391 metres), and (if so) broadcasting that programme. A final settlement of the wavelength will depend, however, on the international wavelength station and on synchronisation experiments now being made at the B.B.C.

The site, on the southern shore of the Moray Firth, is on rising ground behind the small fishing village of Burghead. The country round about is moderately flat, but whether you look south or north or east the distant dark shapes of mountains are to be seen, a reminder of the difficult country the B.B.C. has to contend with up here. Looking out to sea, you are facing north, and on the day of my visit the water was the colour of ink, with the silhouette of mountains on the horizon, across the Firth, a shade even darker; and under the hill where the contractors are busy, the grey cottages of Burghead huddled together, slashed by the icy north wind. A grim and savage scene.

The huge lattice-steel mast, 500 ft. high, seems a strange intrusion on such a landscape, but the building below it certainly should "tone" with the neighbourhood, for its architecture is rather heavily

Scottish, with artificial stone window frames, and walls built of rough-hewn stone from a local quarry—a startling change from the accustomed style of B.B.C. building. In fact, the Burghead building only needs a couple of "candle-snuffer" turrets to become a baronial castle in the style to which Mr. George

Burnett applied, rather scornfully, the appellation "Balmorality," when we were discussing Scottish architectural mannerisms.

The aerial will be an "umbrella" — three wires spaced equidistantly round the mast. The mast-aerial experiment at Lisburn is not being repeated

here; as a B.B.C. engineer said to me: "That type of aerial costs more, and we want to know its performance before we use it elsewhere." So the Northern Ireland transmitter is the test-place for this and other innovations, and Burghead comes too soon to benefit by the results of those experiments.

In one respect, however, North Scottish differs from older Regional stations: power from the mains. A single Diesel-engine generator will be able to run the station at reduced power in an emergency.

A small "lash-up" transmitter of a few hundred watts has been installed to test aerial designs, radiating signals for measurement by field strength vans. The roof of the building is now going on, and the next

step will be the installation of machinery.

A glance at the map will show how this site has been chosen so that a good signal may be given not only to Inverness (thirty miles away) and to the towns adjacent to Burghead—Elgin, Lossiemouth, Banff, Fraserburgh—but also to those on the opposite side of the Firth: Cromarty, Dornoch, Dingwall, Wick. None of these gets either a Regional or a National service at present. The range of the Aberdeen transmitter, I should emphasise, is only some ten miles.

The Post Office is providing high-quality music lines between Burghead and Aberdeen, to link up with the B.B.C. network. The staff at Burghead will number about twenty.

An Hour's Gaelic

It is, no doubt, in anticipation of the large new areas that North Scottish Regional will bring within range of Scottish programmes, that a Gaelic expert has lately been appointed to the Aberdeen studios: Mr. Hugh MacPhee, former assistant secretary of An Comunn Gaidhealach (the Gaelic Association). There are 135,000 Gaelic speakers in Scotland, and they get about an hour of Gaelic in the Scottish Regional programme each week. I do not think this allowance will be increased, but Burghead will make it much easier for those 135,000, most of whom live in the Highlands, to hear the Gaelic programmes.

The B.B.C. chief at Aberdeen is Mr. Moultrie Kelsall, and with half a dozen secretaries and a dozen engineers that completes the staff of this outpost, which is, nevertheless, busier than I expected, not only landlining items to the Scottish Regional programme, but also producing occasional exclusive features of its own—for the programme radiated by the Aberdeen transmitter is a combination of National, Regional and local items, an arrangement unique in the B.B.C. system. Mr. Kelsall's job, fitting together this jig-



Harry Gordon, comedian, who has brought wireless fame to the "Nor-East."

"Aberdeenshire," said Mr. Burnett, B.B.C. Public Relations Officer for Scotland, "is a highly individualistic place."



Serve Britain ?

By LESLIE BAILY

CUT off from the main centres of B.B.C. activity to a greater extent than any other region, the North Scottish area has provided Mr. Baily with an exceptional amount of interesting information. This instalment deals with his visit to the transmitter now nearing completion at Burghead and also with the "lash-up" arrangements still in use at Aberdeen.

saw, is one that necessarily brings as many kicks as ha'pence.

National items have to be included because of the imperfect reception of Droitwich, to which I referred last week—an eloquent sidelight on which is the very special design of the "wireless link" receiver at Aberdeen. Every B.B.C. transmitter has a stand-by receiver tuned to Droitwich, in case lines should fail, but at Aberdeen it has been necessary to in-

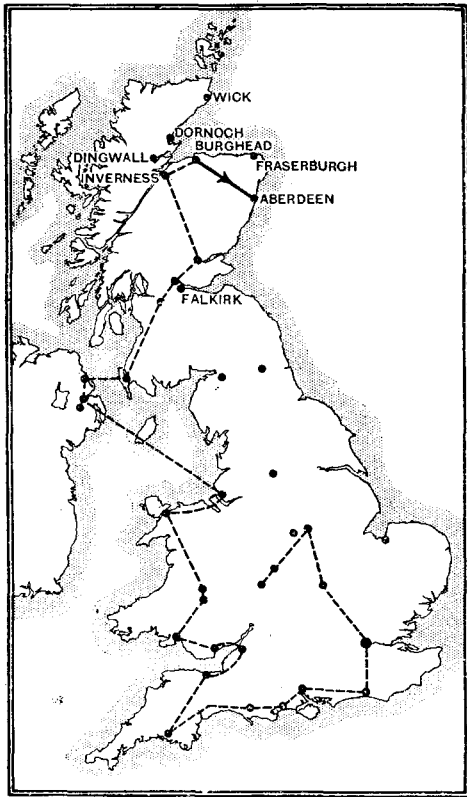

still direction-finding equipment to overcome interference. This outfit I saw in the "grounds" of the Aberdeen transmitter; in other words, a laundry drying-field. Over the field, between two 110ft. masts, hangs the transmitting aerial, its "sausage" lead-in coming down to an old dyehouse, in which the Marconi "Q" transmitter was installed in the autumn of 1923, and where it is still going strong, with scarcely any alteration to that old and famous circuit. The DF aerial—two loops, north-south, and east-west, supported by a 70ft. mast—was erected, complete with lead-covered underground lead-in wires, by the Aberdeen engineer-in-charge, Mr. Inder, and his staff, and an excellent job of work it is.

And that is typical of Aberdeen. Perhaps because the station is so isolated, it

still retains much of the atmosphere that we knew in the B.B.C. ten years and more ago. If the engineers here want a job done they do it themselves. And in the complete informality at the offices and studios, in Belmont Street, one finds the same flavour . . . and in the remnants of antiquated equipment that one finds here and there. In the Control Room I spotted some 1926 vintage amplifiers, used now for rehearsal purposes only . . . the dramatic control panel is a lash-up in Mr. Kelsall's private office, which he also uses at times as a studio for announcing . . . and the effects studio has curtains, seven years old, on its walls!

But a process of modernisation and expansion is afoot. There are three quite admirable studios, lately reconditioned, and a fourth is to be added. A complete new all-mains control room is planned. And a shop which at present occupies the ground floor will be taken over for conversion into a waiting room (at present, when a cast of more than ten arrive for a show they have to wait on the stairs).

"The huge lattice-steel mast seems a strange intrusion on such a landscape."

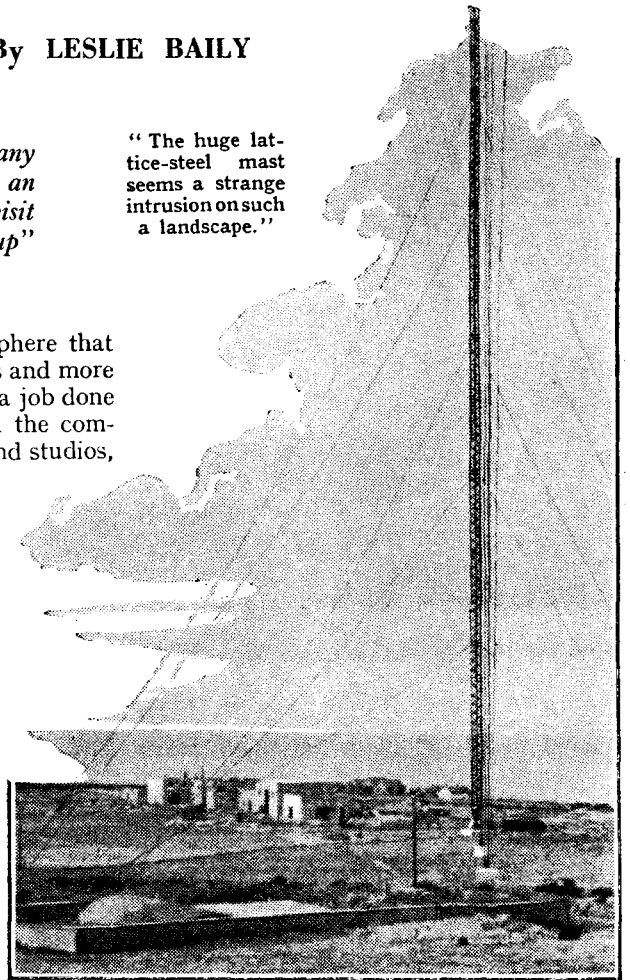

Regularly Mr. Kelsall attends programme board meetings at Edinburgh, and frequently programme producers from Scottish Regional H.Q. come to Aberdeen. During my visit Mr. Burnett was there: officially he is the Public Relations Officer in Scotland, but actually much more than that. And he is an Aberdonian. In fact, both he and Kelsall are typical of

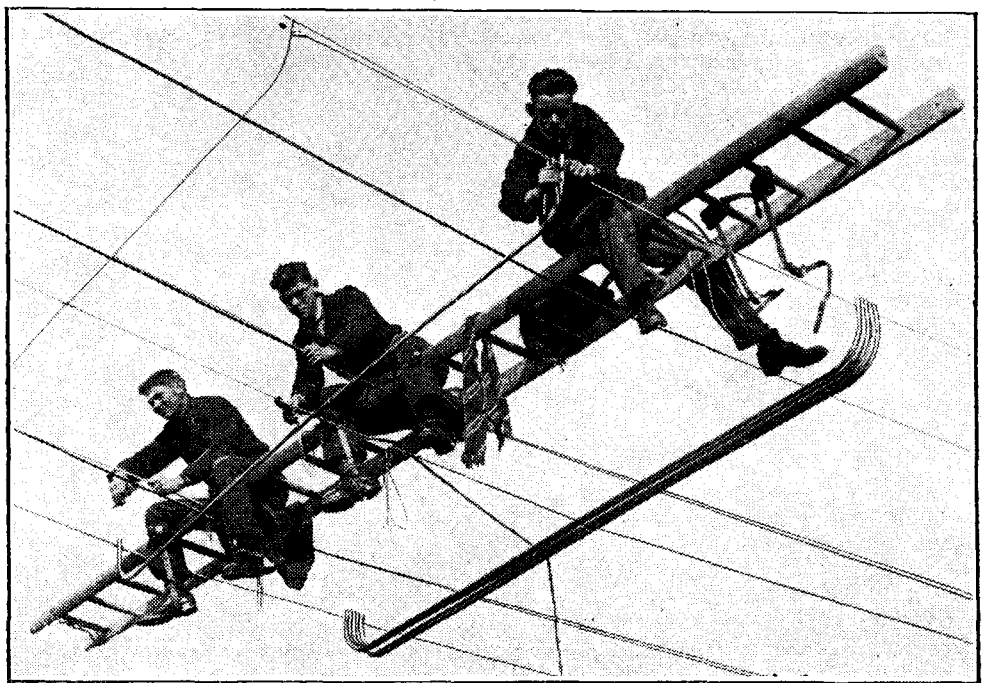

Transmission linesmen at work on feed wires to the new B.B.C. station at Burghead.

Does Broadcasting Serve Britain?—

that cultured, sturdy, forthright kind of man that this part of Britain breeds (the photograph of another was on Kelsall's mantelpiece—Sir John Reith).

"The Aberdonian," said Kelsall, "has a passion for self-education. Talks and church services are popular. There was a terrific outcry when I left Canon Elliott's weekday service out of our programmes."

"Aberdeenshire," said Burnett, "is a highly individualistic place. Dialect is as strong as ever it was. . . ."

"Tenacious of old customs," added Kelsall.

"Untainted by urbanisation. . . ."

"Yes, there's an enormous wealth of untapped programme material in our country districts. Feature programmes are our chief contribution to broadcasting, programmes such as that when we attended the arrival of the fishing fleet at Fraserburgh, or those in which we reflect farm life."

"The Bothy Ballad!" exclaimed Burnett, and Kelsall explained: "Bothy Ballads are songs exclusive to this part of Scotland; they've been made up on the farms, handed down, and they're sung at gatherings of farm hands."

"Once," reminisced Burnett, "I was rehearsing a show in which farm folk took part, and one of them arrived an hour late. 'A sheep fell in a hole—damn your programme, it can wait'—that was his excuse!"

"Yes, we get down to the bedrock of human character here."

"No sophistications—no inhibitions"

"Just robust human nature."

Next Tour: *Falkirk and Edinburgh.*

Below 100 Metres

CONDITIONS since my last notes were written have remained good, especially during the daytime, but, as the commercial operators of the beam services say, it has been definitely ZAL (longer waves) at night. In fact, at this period of the sunspot cycle, the optimum night wave seems still to be determined by the season, i.e., conditions of light and darkness, and not yet markedly by the amount of sunspot activity.

We know that in the last sunspot maximum period 32 metres was the best all-round night wave for Canada, even during the winter, and in the summer months 22 metres could be used round the clock.

Daylight conditions, however, seem to be very susceptible to increased solar activity, and, in particular, the very large group of sunspots—the largest since February, 1933, in fact—which disappeared over the west limb of the sun on Monday, December 9th, once again substantially affecting the lower limit on which communication was possible.

The owner of the station G6DH, of Great Clacton, writes on November 26th that his CW ten-metre signals were getting into Australia so well on that date that he changed over to phone, reported at R8 solid, and worked VK3BQ and VK3YP. This is be-

lieved to be the first VE-G phone contact. G6DH calls "auto" on 10 metres every day from 08.00-09.30 and 13.30-14.15 G.M.T.

Whilst on the subject of 10 metres, it may be stated that conditions appeared to be particularly good on this wave on Sunday afternoon, December 8th, and at least two U.S. amateurs, W2BCR and W2HFS, were heard calling on phone at full loud speaker strength. The intensity of ionisation on this afternoon may be gathered from the fact that both the writer and another amateur transmitter experienced severe fading, whilst QSO on 40 metres during the after-

station may be heard from R4-6, relaying the CHNS programme on 49.10 metres.

Two new German stations, DJI and DJJ, have also been heard in the evenings recently, DJI on 31.02 metres works from 10 p.m. to midnight, and DJJ on 29.88 metres from 7 to 9 p.m. The transmitter used for this service is apparently a new 40 kW set at Königswusterhausen.

In reviewing the period in detail, there does not seem to be much to add to what I have written already, except to comment once again on the extreme range of wavelengths encountered during the fortnight's

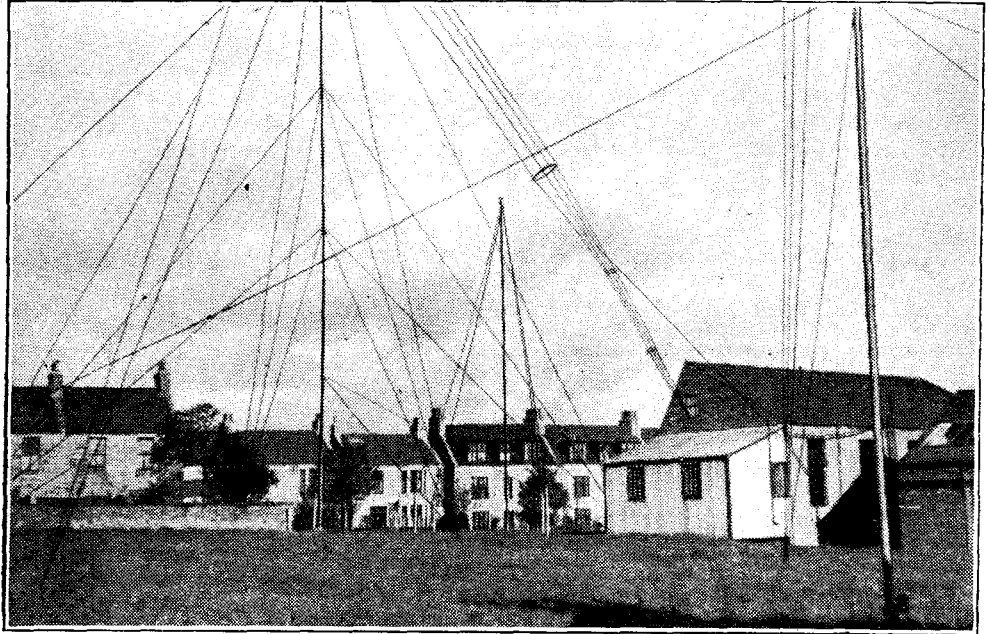

Aberdeen's aerials in a laundry drying-field. The original Marconi "Q" transmitter is still in action in the building on the right, to which the "sausage" download of the transmitting aerial descends. The short mast in the centre background supports the directional receiving aerial.

noon over a distance of some ten miles. This points to reflection of 40-metre signals even at vertical incidence.

Turning now, as promised in the last notes, to the South American and other stations on the 49-metre band, here is a list of a few heard recently:—

YV2RC	..	Caracas	51.72 m.
YV5RMO	..	Maracaibo	51.28 m.
HJ2ABC	..	Cucuta	51.11 m.
HJ4ABE	..	Medellin	50.60 m.
YNLF	..	Managua	50.42 m.
HIX	..	Santa Domingo	50.30 m.
HJ3ABH	..	Bogota	49.95 m.
COCO	..	Havana	49.92 m.
PRA8*	..	Pernambuco	49.67 m.
HJ4ABL	..	Manizales	49.4 m.
CP5	..	La Paz	49.33 m.
YV2RC	..	Caracas	49.08 m.
COCD	..	Havana	48.92 m.
CJRO	..	Winnipeg	48.78 m.
YV3RC	..	Caracas	48.78 m.
HJ5ABD	..	Cali	46.21 m.
YV6RV	..	Valencia	46.0 m.

* Best signal.

This is not a complete list, and none of the above stations was consistently good signals, although PRA8 has been rather good recently.

New stations to look for are YV12RM, Maracay, on 47.62 m. (Maracaibo is a different place from Maracay); shortly YV13RV, Valencia, on 47.39 m.; and XEXA, Mexico City, on 48.54 m.

The 1,000-cycle heterodyne heard recently on GSL from about 8 p.m. onwards is due to a new Canadian CJHX (formerly VEGHX), Halifax, Nova Scotia; after GSL closes down at approximately 9 p.m. this

listening. Below 10 metres good signals were heard in daylight, W3XAL on 16.87 metres was often excellent in the afternoons, and W2XE has been heard on his new 13.9-metre channel (21,520 kc/s) between 3 and 4 p.m.

Up to a few days ago a bad heterodyne was noticed between W2XE and DJE, when both were working on 16.89 metres during the late afternoons.

At 9 p.m. on Friday, November 29th, the U.S. commercial WEU was R9+ on 57 metres, and CKA, Dartmouth, Canada, was also R9 on 55 metres. Later it was very interesting to note DJC on 49.83 metres, very strong with *bad flutter*; whilst DJM on 49.34 metres was equally strong, but *completely steady!*

The next date of interest was, as mentioned previously, Sunday, December 8th, when W8XK on his 19- and 25-metre waves remained audible until an abnormally late hour, and WEM, the R.C.A. 40-metre transmitter at Rocky Point, was heard at great strength testing with DIQ, DJD, and DJB.

Finally, the B.B.C. were heard testing on GSG, 16.86 metres, and GSJ, 13.93 metres, during the Australian transmission on Tuesday, December 10th, presumably with a view to exploring the possibilities of the shorter daylight waves.

Conditions on Tuesday evening, December 10th, resembled those on Sunday, December 8th, and W8XK on 25.27 metres was an excellent signal, R9-7, merit 4-5, until midnight. The South American station, HJ4ABA, Medellin, formerly working on 25.65 metres, but now on about 25.4 metres, was also a good signal.

UNBIASED

A Modern Reporter

New Readers Commence Here.

Free Grid, an earnest seeker after truth, finds himself at a meeting of the local Urban District Council sitting next to the star reporter of one of our great national dailies. The man is nodding drowsily whilst the speeches are being taken down on an automatic recorder. He explains that he invented this device after being attacked by a strange form of sleeping sickness which had baffled Harley Street. Now read on.

I WAS still more amazed when my new-found friend came to despatch the contents of the records to his office at the close of the meeting. On learning that he intended to send the results by telephone by means of a small reproducer, I supposed that the process of transmission would be as long as the speeches, namely, a couple of hours, so I demurred at his invitation to a telephone box. At length, however, I reluctantly accompanied him. To my surprise he proceeded to run the special reproducer at terrific speed. Speech was completely unintelligible, but our task was completed in ten minutes.

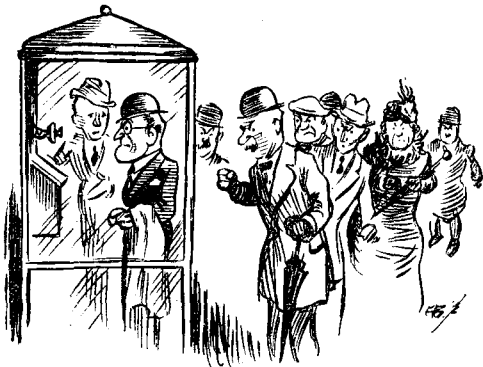

Two hours in the box.

The idea, he said, had first been used by the Germans during the war when they had mystified the allied secret service department by sending out from their big wireless transmitters what were nothing but continuous high-pitched shrieks. These shrieks were, as afterwards discovered, morse code characters recorded on a wax cylinder revolving at the normal rate and then sent out at tremendous speed over a transmitter and received by the German secret service agents in neutral countries on wax cylinders revolving at an equally high speed, these cylinders subsequently being run on a reproducer at the normal rate in order to decipher the message. Secrecy and speed were achieved at one fell swoop, and my newly-found friend was attaining the same ends by similar methods, there being a high-speed recorder attached to the telephone in the office of his newspaper.

In my endeavours to improve matters I at once suggested that still higher speeds could be used so that two-hour speeches

would be compressed into three minutes instead of ten, thus saving many tuppences. He assured me that this possibility had not been lost sight of by his Editor, who hailed from north of the Tweed, but a snag was found. As the speed increased so did the pitch of the speech rise, and it had been found that any greater speed than that which was used resulted in frequencies too high to be dealt with by the G.P.O. land lines. There was, however, he admitted, a likelihood that this little difficulty would disappear now that the G.P.O. were considering the necessity of installing special wide-frequency land lines for the purposes of television.

A further thrilling instalment next week: perhaps.

A Bohemian Night's Entertainment

AS those of my readers who are compelled to live in the London area are aware the habit of placing Christmas trees in the porches of churches and other places before, during, and after Christmas is gradually spreading. The efforts made over here, however, are as nothing compared with those in various places on the Continent. In certain parts of Europe, such as in the ancient city of Good King Wenceslas, this picturesque habit is pushed to the extreme, so that one finds these delightfully decorative trees dotted about even in the main squares of the city. This is, as I feel sure you will agree, a highly fitting custom in the city of this good and saintly king.

I was so fired by an account given me by a native of Bohemia that I flew across with one of the little Grid Leaks to investigate things at first hand. After we had done a tour of the city streets we were both feeling a little fatigued and out of sorts, and so, hastening across the rolling Vltava, *via* the picturesque Karel bridge, we climbed wearily up the interminable steps to the cathedral of St. Vitus in order to grasp the magic handle on the door of the Wenceslas chapel, the doing of which, so local tradition asserts, is said to confer immunity from illness and weariness of the flesh to all good pilgrims.

This done, and thus feeling thoroughly rejuvenated, we started to do the sights of the cathedral and the adjoining castle. Taking up our stance in front of a famous painting we were astonished to hear a stentorian voice bursting forth apparently from the picture; it seemed for the moment as though we were being addressed actually by the painted image

of the old Bohemian king in the picture, and I, for my part, felt my few remaining hairs rising on end. After all, anything may happen in a city like this where they have magic door handles and a public clock in which, when it strikes, the figure of death itself solemnly tolls out the hour, and a procession of figures marches round the dial.

When I had regained my composure the Grid Leak and I moved on to the next picture, only to encounter the same startling effect. Hastily passing along we found that standing in front of other pictures, or even statues, produced a similar phenomenon. We sought enlightenment from a stately and bearded individual who pointed out that behind each

By FREE GRID

picture and other *objets d'art* was a concealed record and public-address apparatus. This was set in motion by the tourist himself who unknowingly cut an invisible ray when standing in front of the object in question. As the record is made in the local lingo we had naturally been unable to understand what it was all about.

I am now busily engaged in trying to improve on the idea so that it will be equally beneficial to foreigners. It would, of course, be quite easy to have half a dozen records in as many languages and arrange for the tourist to operate one of a half-dozen push buttons according to his nationality, but such an idea is, I feel, too crude and unworthy of me. My problem is to find out how the ray may be made to differentiate between, say, a German and an Englishman. I am at present toying with the fact that the former usually possesses a body stouter and more opaque than the latter, but I must confess that at present I haven't got

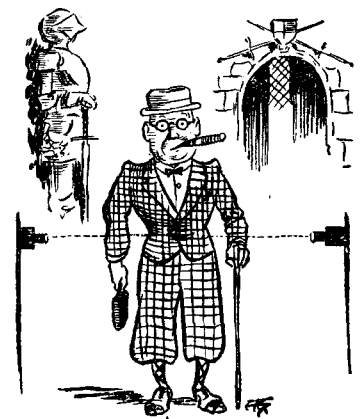

Unknowingly cut an invisible ray.

very far and am frankly puzzled. Perhaps you can help me.

I am, by the way, still in Central Europe, having lost the return half of my ticket, and the more immediate problem of getting back in time for the New Year's celebrations engages my attention. I hate the idea of stowing away, but what else is there to do?

SUB-HARMONICS

By N. W. McLACHLAN, D.Sc.

WHEN a cone diaphragm moving coil loud speaker is tested near its maximum power output with a beat frequency oscillator, the pure note often gives place to a raucous tone in the middle register. The cause and cure of this form of distortion are fully explained in this article.

An Interesting Form of Distortion in Cone Diaphragms

IN a series of articles which appeared in *The Wireless World*, the *Philosophical Magazine*, and *Proc. Phys. Soc.* some years ago, chapter and verse were given for the vibrational frequencies of cones. In a hornless loud speaker there are three main sets of vibrations: (a) at low frequencies due to the diaphragm resonating on the centring spider and outer surround, (b) resonance of the air column within the cone at from 700 to 1,000 cycles according to its axial length, (c) resonances of the cone itself above 1,800 cycles or thereabouts. A

Fig. 1, F is a massive low-frequency tuning fork (say 30 cycles or 50 cycles), and S is a thread several feet long, one end of which is attached to a prong, and the other to a fixed support. If the fork is made to vibrate along the direction of the thread AB and the tension of the string is properly adjusted, the thread vibrates at right angles to AB. If the fork makes thirty complete vibrations per second, the string will make only fifteen vibrations per second, i.e., its frequency is one-half that of the fork. To get the best results, the vibration of the fork should be continuous, or at least it should last for several seconds each time it is set in motion. The experiment can be performed by using a steel strip fixed in a vice and actuating this from an electromagnet, or a reed loud speaker unit, or a moving coil speaker driven from the electric supply mains.

occurs. The fundamental tone is accompanied by another main tone, whose frequency is one-half² that of the fundamental. The frequency range over which this effect occurs lies between 500 and 4,000 cycles, but the range for any par-

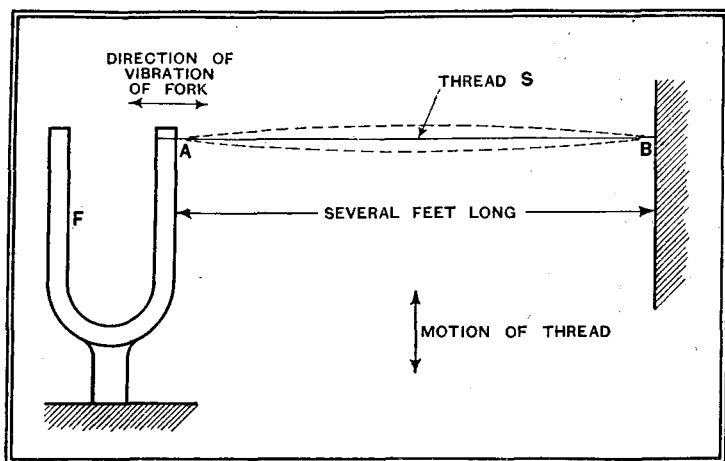

Fig. 1.—Diagram illustrating Melde's experiment in which the thread S vibrates at half the frequency of the tuning fork. The vibration is not along the thread, but at 90 degrees to it.

powerful resonance of type (a) may occur between 40 and 200 cycles, and introduces an unpleasant boom when reproducing speech, whilst the upper-frequency register is largely dependent upon type (c), but these resonances must be properly controlled.

The experiments to which reference was made above were conducted with moderate acoustic outputs, so that there was no difficulty in diagnosing the various resonances. When, however, the output from a conical diaphragm exceeds a certain amount,¹ an important secondary effect occurs which mars reproduction of speech and music. Before describing the secondary phenomenon as it occurs in loud speaker cones, we shall take the simple case of a vibrating thread.

The experiment to be described was first performed by Melde many years ago. In

¹ It is perhaps better to say "when the vibrational amplitude exceeds a certain amount."

speaker. If the sound output from a loud speaker is measured at a given frequency, it will increase in proportion to the power

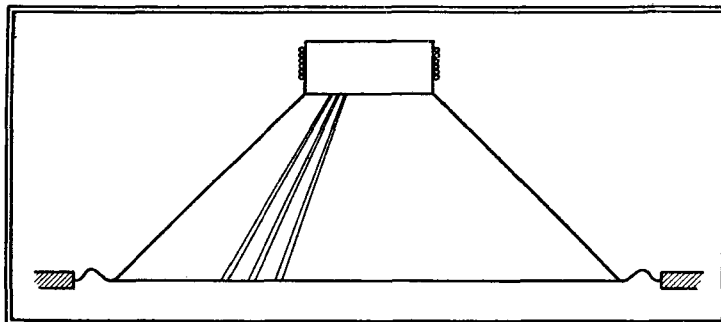

Fig. 3.—Illustrating the division of a straight-sided cone into strip elements. The corrugation at the edge is to allow axial motion. This type of edge was used in the Telefunken tests.

input to the coil as illustrated in Fig. 2. But if the frequency lies within a certain range, then at a certain value, if the input to the coil is gradually increased, a change

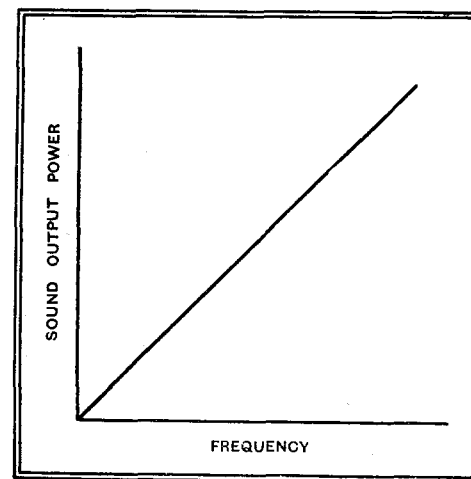

Fig. 2.—Illustrating a linear relationship between frequency and sound output from a loud speaker.

ticular cone depends on the size, thickness, and type of paper or other material used. Even if the input to the speaker is increased considerably, there does not appear to be any tendency for cones to exhibit this effect outside the range 500 to 4,000 cycles.

One reason for this peculiar behaviour of the straight-sided cone will be understood from the explanation already given in connection with the thread in Melde's

experiment. Suppose we consider the cone to be divided up into a very large number of narrow strips, as illustrated in Fig. 3. Then, if each strip is considered separately, there is a tendency to bend first one way, then the other. This tendency is counteracted by the additional stiffness due

to the remainder of the cone on each side,

² The tone is said to be raucous or harsh, which indicates that either the frequency is not exactly half, or it undergoes a variation.

Sub-Harmonics—

but eventually, when the driving force is large enough, there is bending, as in the case of a straight bar, which results in a sub-harmonic whose frequency is one-half that of the driving current.

The point concerning the "critical" electrical input power at which the

occur immediately, since in the neighbourhood of the "critical input power" the time taken to reach the maximum output may be 20 seconds. For much larger input the time may be 0.1 second. Accordingly, if a 600-cycle tone, well above the critical input power, were supplied to a conical diaphragm for, say, one second it would excite the raucous tone.

Suppose the electrical input at 600 cycles is steadily increased from a low value and the corresponding acoustical output is

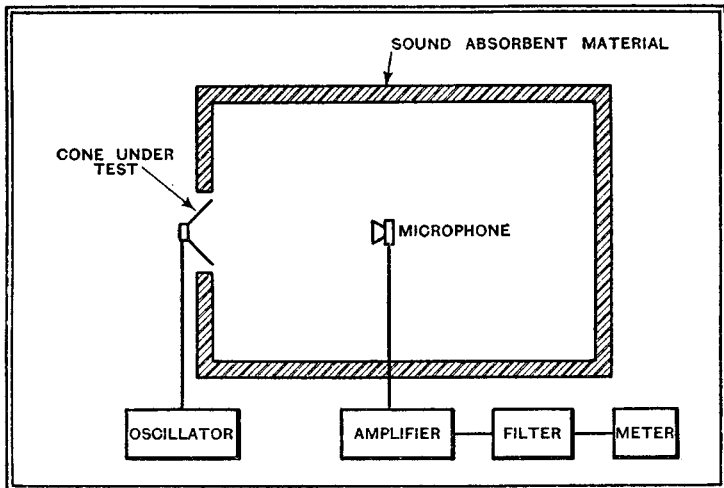

Fig. 4.—Arrangements for testing diaphragms for sub-harmonics.

raucous tone commences will now be considered. A microphone is suspended about a metre from the cone, the apparatus being in an acoustically "dead" room, and a filter is inserted to eliminate the current due to sound pressure at the frequency supplied to the coil, i.e., the fundamental (see Fig. 4). The input frequency is increased from, say, 450 cycles very slowly until at a certain point, say 600 cycles, the sub-harmonic is obtained. The input is then reduced and again increased very slowly, each step occupying several seconds, until the sub-harmonic occurs. At

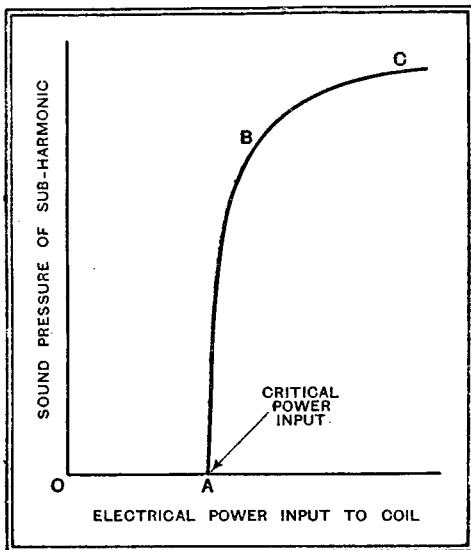

Fig. 5.—Curve showing the relationship between sound power due to sub-harmonic and the electrical power supplied to the driving coil. The sub-harmonic does not occur until the power input exceeds the value OA.

this critical value the input is increased gradually, and a curve of the form illustrated in Fig. 5 is obtained. The output of the sub-harmonic rises very quickly and reaches a saturation value. This does not

measured. Under normal conditions the relationship between sound power and electrical input will be a straight line, as shown by OA in Fig. 6. At the critical input, however, there is a sudden drop in power from A to B, after which the line continues along BCD. This indicates a point of instability due to the occurrence of the sub-harmonic. The sound output at Q is now reduced by the amount PN, i.e., the output would have been PN in the absence of instability. The line BCD represents the total sound power from the diaphragm, and the loss PQ is probably caused by considerable internal friction in the paper due to the large lateral vibration.

Before showing how the raucous tone has been eliminated, let us consider Fig. 7. Here we have a curved bar acted upon by an alternating force of such a value that when it stretches the bar the latter is never straightened. Under this condition

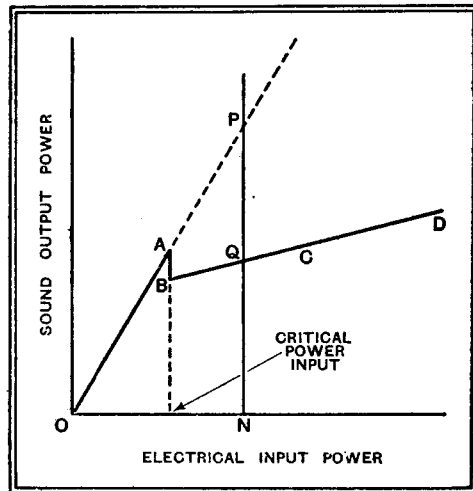

Fig. 6.—Relationship between electrical input and total sound output. From O to A only the fundamental frequency is present, but from B to D both the fundamental and the sub-harmonic are present.

the bar will always be bent. It will take the form (a) of Fig. 7 when compressed, and form (b) when in tension, so the bending and unbending will follow the corresponding alternating forces, and the two-frequencies will be identical.

Curved Cones

Putting this into practice, it follows that a curved-sided cone is required, as shown in Fig. 8, and this is found to be the solution of the problem of almost eliminating sub-harmonics. With a cone of this type there is a trace of instability between 1,200 and 1,500 cycles, when the electrical input to the driving coil is very large.

The foregoing description of instability, sub-harmonics, and the raucous tone³ effect is based on a reprint of a paper published in *Telefunken-Zeitung* by F. von Schmoller, for the English translation of which the author is much indebted to Mr. F. H. Smith. The cones illustrated in the paper did not have free edges, but

³ The raucous tone effect was first discovered by Savart many years ago when exciting longitudinal oscillations in a straight bar. In addition to the longitudinal oscillation there was a lateral oscillation of approximately half-frequency. This lateral oscillation occurred due to the fact that when the bar is in compression (due to longitudinal vibration) it tends to bend, just as a lath does if held vertically and pressed on the ground. To this sound Savart gave the name "son rauque." The phenomenon is of the second order and is negligible for very small longitudinal amplitudes.

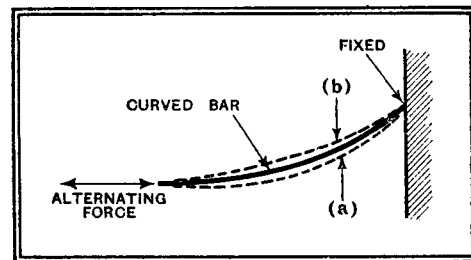
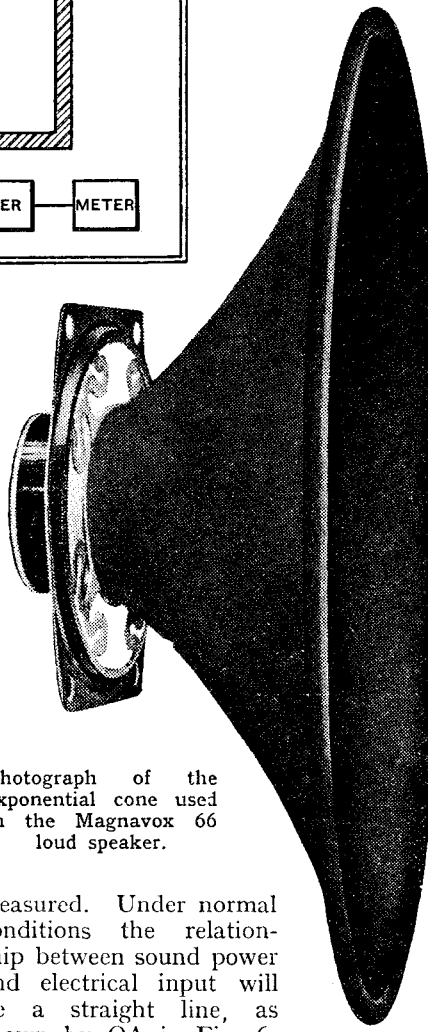

Fig. 7.—Diagram illustrating the vibration of a curved bar when subjected to an alternating force.



Photograph of the exponential cone used in the Magnavox 66 loud speaker.

Sub-Harmonics—

were as shown in Fig. 8, where a circular corrugation is used to permit axial motion. This type of edge introduces appreciable constraint where very low-frequency vibrations are concerned, but above 500 cycles the effect is small. Whether "son rauque" occurs with any straight-sided cone, whatever the edge condition, i.e., free or constrained, is a matter for experimental investigation.

As a matter of historical interest it may be mentioned that sub-harmonics were first reported in this country by F. R. W. Stafford in *The Wireless Engineer*, March, 1933, but nothing was said about "son rauque." The month following, H. F. O. Benecke, of the Telefunken Co., wrote to *The Wireless Engineer* saying that the effect had been observed in their laboratories when testing conical loud speaker diaphragms. He said that the sub-harmonic could be explained by reference to Melde's and Savart's experiments. A month later P. O. Pedersen reported in the

same journal that he had obtained sub-harmonics using a Jensen auditorium speaker, and that an exhaustive theoretical and experimental study of sub-harmonics had been made at the Royal Technical College, Copenhagen. Not only cones had been studied, but also mechanical and valve oscillating systems. He dealt with the problem in a comprehensive manner in the *Journal of the Acoustical Society of America*, April and July, 1935. The explanation given is quite different from that brought forward by Benecke and von Schmoller. Pedersen contends that sub-harmonics are due to non-linearity of the centring device or the surround, or a combination of both of these. In matters of this sort, where opinions differ, it is preferable to know which explanation is the more likely to be correct. At the Radio Show, therefore, I took the opportunity of discussing the matter with several loud speaker manufacturers in order to obtain as much information as possible on the point at issue. Every manufacturer was aware of the occurrence of sub-harmonics, since he encountered them when testing speakers using a beat-tone oscillator. The most prolific frequency range for their occurrence appeared to be from 1,000 to 2,000 cycles. The tendency for these harmonics to arise was reduced by using thicker paper, and it largely disappeared with exponential or curved-sided cones of reasonable thickness. Corrugating a straight-sided cone also had a beneficial effect.

Through the courtesy of Mr. S. J. Tyrrel, of the Celestion Co., I was enabled to confirm some of these points, although it ought to be mentioned that one exponential cone gave a sub-harmonic when fed with 1,000 cycles, the power input being

4 watts. Certain straight-sided cones were more prone to sub-harmonics than others, especially if the main resonance peak above 2,000 was large. The sub-harmonic occurred approximately at the valley below the resonance peak. At 2,000 cycles the vibration of the cone associated with the 1,000-cycle sub-harmonic seemed to be confined to a narrow ring about two-thirds the distance from the apex, this being explored with a stethoscope. By pressing lightly on this ring the sub-harmonic disappeared, whereas with the exponential cone both sides of the ring had to be pressed to stop the vibration.

If the cone were thick enough for buckling to be negligible, the occurrence of sub-harmonics could only be due to some other cause, e.g., non-linear action

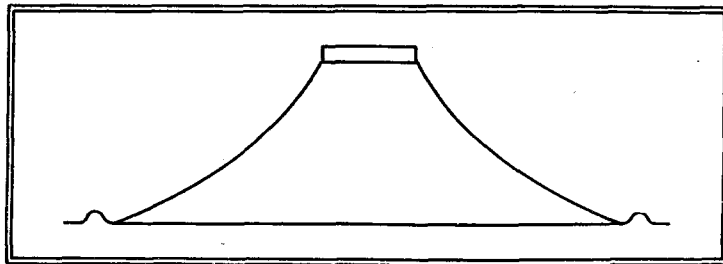

Fig. 8.—Type of cone used during the Telefunken tests.

of the surround or the centring spider, as suggested by Pedersen. The cone in the Jensen speaker used by Pedersen is similar to that used by the Telefunken Co. Since sub-harmonics are substantially

eliminated in a curved-sided cone, it appears that non-linear action is of little importance, so far as this particular phenomenon is concerned. The sub-harmonics occur as high as 2,000 cycles (fundamental 4,000 cycles), and as the amplitude of motion is then quite small non-linear action would not be expected to be of much importance.

By virtue of the foregoing evidence, it seems that, unless conditions are radically different from those which obtain in modern loud speaker construction in this country, sub-harmonics are mainly due to lateral buckling of straight-sided cones. Finally, it may be of interest to mention that the first exponential cone was made by the writer in 1924, and it is described in British patent specification 257,317. It was constructed using a special type of chemically treated cloth formed into an ordinary straight-sided cone. A heavy weight was suspended from the apex, and the cloth doped with a solution of celluloid in acetone. Several coats of this solution were applied, and a final coat of aeroplane dope used to finish off. One of the cones in question is in the Science Museum, but two more are in my possession. They are now in as good condition as they were eleven years ago when first made. It may be remarked that in 1924 beat oscillators—or any other form of audio-frequency oscillator, for that matter—were not available for testing speaker diaphragms, so that there would have been no opportunity of discovering sub-harmonics.

Few or Many Valves ?

“Just as Many as Will Do the Job Best”

By “CATHODE RAY”

IN a debate on this subject one would, of course, preferably get a Briton to uphold the merits of few valves and an American to speak in favour of the multi-valve policy. The judge, of either nationality, would open the proceedings in the usual manner by enquiring “What is a valve?” If American, he would be satisfied with the answer, “A ‘toob,’ m'lud”; if English, the question might be merely rhetorical, requiring no answer, or (if he were technically discerning) arise from a very proper desire to have the nature of the term “valve” clearly defined. Should a double-diode triode be considered as one, two, or three valves? Should a power rectifier rank as one or nought?

To the public, a valve is an inverted bottle plugged into a socket; and, as it is manifestly hopeless to teach them any better, manufacturers and dealers now generally consider it wise to say nothing about number of valves. You see, they would be caught either way. If the set

were designed to get the world on two multiple valves, double-reflexed both ways, the prospective customer would wave it aside with a “No, thank you! I can get a 5-valve set at £1 cheaper.” It used to be a matter of social pride and prestige to have more valves under the bonnet than any of the neighbours. On the other hand, if the designer used nine simple valves run well within their capabilities, the retort would be that somebody else's product could bring in two stations more with three valves fewer. I remember a certain model that splashed seven valves, at a time when three was the standard number. No greater range was claimed—only better output, simpler control, and such unconsidered trifles—but it was certainly expected, and that set was a flop.

So now receivers are offered to the market as the Mighty Harvester of the Ether, or Model 12036/MPQ.AC/DC.

In days gone by, the valve numbering business was simple; there was only one

Few or Many Valves?

sort of valve, and if you wanted more "power" you had to stick another one on. A 4-valve set always did much more than a 3-valve set—it would howl in several more ways at least. And both were immeasurably superior—technically and socially—to the 2-valve set.

As specialised and multiple valves appeared, the radio manufacturers tried to persuade the public that they were being given more valves than they could see on raising the lid—THE SUPER AC THREE ("but does the work of seven ordinary valves"). There are still attempts of this sort; for example, by specifying the number of "stages"; but they never seem to catch on very well with the great seven millions. Still, there are interested people, such as you who are reading this page; so the arguments for many or few valves may be considered for a moment.

Five-valve Circuit with Three Valves

There are three ways in which more valves can be used to give the same general performance. Multiple valves, where specified, can be replaced by the corresponding simple valves. A 3-valve superhet, comprising triode-pentode, variable mu pentode, and double-diode-pentode, can be made into a 5-valve set without altering the circuit or performance in the slightest. Among reasons that may prompt such a policy are: If one section of a multiple valve "goes," the whole must be jettisoned; stray capacities may sometimes be slightly reduced by using separate valves; it looks as if better value for money were being given.

Another way of putting up the number of valves is to use them for auxiliary or subsidiary purposes—AVC, noise suppression, contrast expansion, tuning correction, push-pulling, and so forth. The Americans do a lot of this; so that in a 15-tube receiver it may be found that only about six are in the direct amplification line—the remainder are doing odd jobs. Over here it has been almost a matter of honour with a designer not to stoop so low as waste a whole valve on these refinements. That would be almost as bad as having recourse to a second motor car to carry the engine. He must persuade one of the main valves to do the work as a side-line, or else confess lack of ingenuity. In the days when valves cost fabulous sums, plus twelve shillings and sixpence each in royalties, there was sound financial reasoning at the base of this. Now there is little more than pride. Technically, one may expect the extra facilities—and the main functions also—to work more effectively and reliably when they are entrusted to separate valves.

The third method of using up a lot of valves is to withdraw from the competition to extract more from a limited number of them than anybody else. Here again the original motives were chiefly economic, but are now more a matter of pride. It must be the British temperament. I am sure that if the horse-power

tax were lifted altogether there would still be plenty of designers striving for the maximum b.h.p. per litre.

Technically, the right policy is to use just as many valves as will do the job best. Commercially, one must add "... for the cost allowed." And it may cost no more to employ eight cheap valves of moderate efficiency, in cheap circuits of no excessive precision of adjustment, than to use three marvels of complexity in glass and wire, working in

circuits where everything is doing about three things at once, and all of them within 0.01 mm. of bursting point, so that when a valve is replaced it is either unstable or off the map entirely, and the circuits are so ingenious that it is impossible for anybody except the Chief Engineer to trace a fault in them.

Of course it is sounder to use more valves... all the same I for one will be just as keen as ever to make three valves give the results of the other man's four.

Short-wave Kit Set

Band-spread Tuning and Wave-range Switching

ANY keen wireless man can in a few moments dash off the circuit diagram of a short-wave detector-LF set. The finished result will, in essentials, be very much like the arrangement shown in the accompanying diagram; there is little scope for originality. But it is a long step from the bare circuit to the final receiver; practical experience, and even more—for want of a better expression, let us call it a sympathetic understanding of the waywardness of short-wave signals—is needed if the set is to be as pleasant to operate as the subject of this review.

Although the circuit arrangement of the Lissen Band-spread Short-wave 3 is straightforward, there are one or two departures from convention. A resistance replaces the customary HF choke in the anode circuit of the detector valve, and the tuning system is so arranged that the wavelength coverage on each of the two bands (13-28 m. and 25-55 m.) is divided up into twenty "zones," determined by the setting

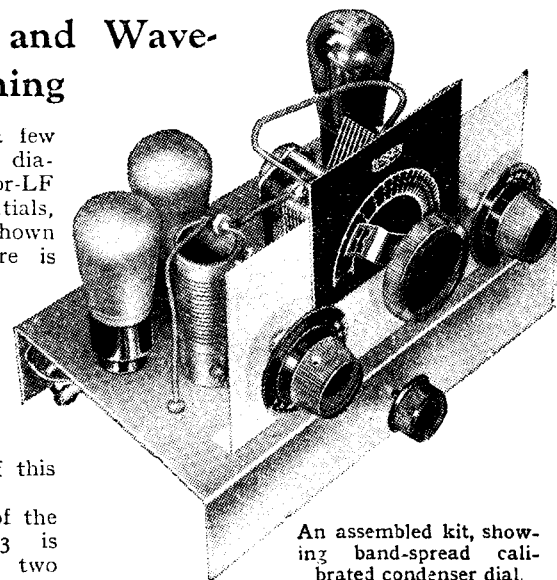

An assembled kit, showing band-spread calibrated condenser dial.

denser. By this simple method, the exploration of any band is facilitated and the tediousness of operating a dial with an excessively high reduction ratio is avoided.

Reaction control is extremely good in the

Lissen set, and hand-capacity effects are almost negligible. Under quite unfavourable conditions, a good selection of programmes (including American) were obtainable without difficulty, and one or two blind spots that were observed were largely attributable to the fact that the aerial was unsuitable for short-wave work.

Supplied as a set of parts ready for assembly, complete with valves but

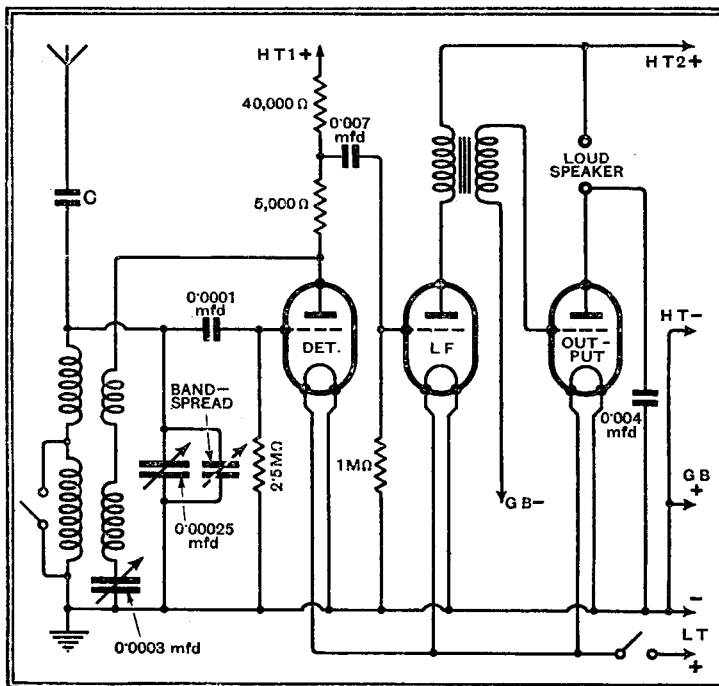

Circuit diagram of the Lissen Band-spread Short-wave 3. The aerial condenser C is built into the coil assembly.

of the main condenser. The dial of this condenser is calibrated in numbered divisions corresponding to the coverage of the parallel-connected band-spread con-

without batteries or loud speaker, the set costs £3 9s. 6d. Everything is arranged for easy assembly and wiring. The makers are Lissen, Ltd., Edmonton, London, N.18.

Listeners' Guide for



As the last sounds of the St. Paul's Watchnight Service die away, Big Ben will sound "zero hour" of 1936.

"CHIMES AT MIDNIGHT."

WHILE ringing in the New Year the B.B.C. is also ringing the changes on an old custom—old, in broadcasting—of giving us a réchauffé of the past year's radio events. This warmed-up business is to be dropped on December 31st, and, instead, we are to have actuality broadcasts from different parts of the country, giving glimpses of how the New Year is being welcomed by shepherds on the moors, family circles in front of the Yule log, by sailors in ships, and pilots in 'planes.

Laurance Gilliam has devised the feature, which is called "Chimes at Midnight."

The programme opens at 11 with prose, poetry and music reflecting the last hour of the year—and leads up to the Watch Night service from St. Paul's Cathedral, which is being conducted by the Dean of St. Paul's, the Rev. W. R. Matthews, at 11.45. As the last sounds of the service die

away, Big Ben at midnight will sound "zero hour" of 1936. An innovation will be the sudden switching over to a microphone on the steps of St. Paul's so that listeners can overhear the Cockney-Caledonian rejoicings as the crowds dance and sing. Merging into these sounds will come the chimes from the Guildhall, Berwick-on-Tweed, and then will follow Scottish voices from outside the Tron Kirk, Edinburgh. "Auld Lang Syne" will wind up the programme, which will be followed by dance music until 12.30.

FROM LAMBETH PALACE

THE last Sunday religious service of 1935 will be the first from Lambeth Palace, and will be conducted by the Archbishop of Canterbury from his private chapel (Nat., Sunday, 7.55). Sir Walford Davies, Master of the King's Musick, is himself conducting the B.B.C. Singers, who will form the choir.

PROMS. IN LITTLE.

THE "little" proms. season opens on Monday—not, as might be expected, with a Wagner programme, but with items by various composers, highlights being Rachmaninoff's Pianoforte Concerto No. 2, with Solomon as soloist, and Beethoven's Fifth Symphony (Nat., 8).

Choosing programmes for such a short season is no easy matter and an effort has been made to concentrate as many representative works as possible into the twelve nights, from December 30th to January 11th. The B.B.C. Symphony Orchestra of ninety will again be led by Marie Wilson, and the conductor is, of course, Sir Henry J. Wood.

In this short time, however, an effort is being made to cater for the adventurous younger generation who will not be put off with too many traditional favourites. One work is to have its first English performance—Concerto No. 1 for pianoforte, trumpet and strings by Shostakovitch; another special feature will be a Hungarian programme, in which Zoltan Kodaly will personally conduct his suite, "Hary

Janos." At the same concert Béla Bartok will play his Second Pianoforte Concerto (Tuesday, January 7th).

The special concerts next week are devoted to Tchaikowsky (Tuesday, Reg.), Holst and Vaughan Williams (Wednesday, Reg.), Mozart and Haydn (Thursday, Reg.).

PICKWICK.

THE musical mandarins of the B.B.C. get most of the kudos so it is refreshing to find that, for once, they take a back seat in favour of the Talks Department, which is sponsoring the Pickwick Centenary programme on Thursday next. A musical Pickwick—and some of them at Portland Place would love to dress him up in crochets and quavers—would be worse than a crooning Falstaff.

V. C. Clinton-Baddeley, who has devised the programme, has been carrying out a thorough research among original MSS., letters and documents in the Dickens Fellowship Library, so we shall have true-to-life pictures of the drive to Rochester, the scene with Mrs. Bardell, the Eatanswill Election, Christmas at Dingley Dell, and part of the trial scene. Mr. Pickwick will come to life while all the assembled characters of the famous "Papers" toast his health.

Some music there must be,



CREATOR OF PICKWICK. Charles Dickens in 1838, when the "Pickwick Papers" were first gripping the English-speaking world. A Pickwick Centenary programme will be broadcast on Thursday next.

and this will be given by the Gershom Parkington Quintet, with the addition of a harp for the Christmas Party, for is it not written: "It was accompanied by the two best fiddlers and the only harp in all Muggleton"? Mr. Pickwick will be played by H. O. Nicholson.

"Mr. Pickwick, a Hundred Years Old," will be heard in the National programme on Thursday at 8.30.

MAX BEERBOHM.

THE spacious life of Edwardian London will be lived again for twenty minutes on



WHO IS IT? A typical caricature by Max Beerbohm, the famous wit and satirist, who comes to the Regional microphone at 9 on Sunday to talk on "London Revisited." "Max" will revive memories of the Edwardian period.

Sunday evening at 9 o'clock when Max Beerbohm, famous wit, satirist and caricaturist of those days, contributes the final talk in the "Revisited" series. Having lived at Rapallo, Italy, for more than a quarter of a century, the inimitable Max has just returned to his native London, and will give his impressions of London to-day.

the Week = Outstanding Broadcasts = at Home and Abroad

HIGHLIGHTS OF THE WEEK

FRIDAY, DECEMBER 27th.

Nat., 8, Robert Lorraine as Scrooge. 9.15, Piano Recital by Cecil Dixon. 10, Brahms, by Dame Ethel Smyth. Reg., 7.30, B.B.C. Dance Orchestra. 8.15, Sir Landon Ronald conducting London Symphony Orchestra.

Abroad.

Vienna, 8, Wagner Concert by Vienna Symphony Orchestra.

SATURDAY, DECEMBER 28th.

Nat., 7, "Saturday Magazine." ¶Music Hall. ¶B.B.C. Orchestra. Reg., 8.30, Sonata Recital by Albert Sammons (Violin) and Wm. Murdoch (Piano). ¶Medvedeff's Balalaika Orchestra.

Abroad.

Milan No. 1, 7.15, Opera: "Lohengrin" (Wagner).

SUNDAY, DECEMBER 29th.

Nat., Eugene Pini and his Tango Orchestra. 3.30, Northern Ireland Orchestra. 9, Leslie Jeffries and Orchestra, Grand Hotel, Eastbourne.

Reg., Serge Krish Septet. ¶B.B.C. Military Band. 9, London Revisited by Max Beerbohm. 10 B.B.C. Orchestra.

Abroad.

Munich, 7, Schubert, "Darling of the Gods"—a rhapsody.

MONDAY, DECEMBER 30th.

Nat., 8, "Proms"—opening night. ¶Leslie Bridgewater's Quintet. Reg., 8, Variety Hour. ¶Fred Hartley and his Novelty Quintet. ¶B.B.C. Military Band.

Abroad.

Prague No. 1, 7.45, Czech Philharmonic Orchestra.

TUESDAY, DECEMBER 31st.

Nat., Alfredo Campoli Trio. 8.20, Pantomime: "Cinderella." ¶B.B.C. Theatre Orchestra. 11, New Year's Eve Programme. Reg., 8, Tchaikowsky Promenade Concert. 8.40, "Auld Year's Nicht"—from Jedburgh. 10.40, B.B.C. Dance Orchestra.

Abroad.

Paris, P.T.T., 10.30, Opera: "Boris Godunov" (Mussorgsky).

WEDNESDAY, JANUARY 1st.

Nat., B.B.C. Dance Orchestra. 8.30, Old Time Ballad Concert. 10, "The Snow Queen." Reg., Recital by Isolde Menges (violin) and Harold Samuel (Piano). 9.45, Larry Addler and B.B.C. Variety Orchestra. 10, Promenade Concert, Part II

Abroad.

Leipzig, 6.30, Gewandhaus Concert.

THURSDAY, JANUARY 2nd.

Nat., Carroll Gibbons and the Savoy Hotel Orpheans. 8.30, Pickwick Programme. Reg., B.B.C., Midland Orchestra. 9, Variety of Music. ¶Promenade Concert, Part II

Abroad.

Paris, P.T.T., 8.30, Operetta: "La Mascotte" (Audran).

HANS ANDERSEN PLAY

"THE SNOW QUEEN," by Hans Andersen, adapted for broadcasting by Francis Dillon, should be one of the most interesting programme events of the week (Wednesday, National, 10). There is an unusual cast, for it includes not only Lilian Harrison as the Snow Queen and Philip Wade as a Raven, but actors and actresses representing Sunshine, Swallows, Flowers, Pigeons and Nine Applicants for the hand of the Princess. This fantastic type of drama is often ideal for broadcasting, for the microphone eliminates certain crudities apparent on the stage.

OPERA ABROAD

THE ultra-modern Austrian composer, Strecker, has not scorned an age-old folk song which forms the theme of his opera, "Aennchen von Tharau," which Munich is broadcasting to-night at 7.10.

Richard Strauss' "Rosenkavalier" is the highlight tomorrow evening (Saturday), when it is given in a concert version from Brussels No. 1. This opera owes much to its scenic effects, so it will be interesting to hear how it comes over as a studio production.

Warsaw on Sunday at 7.10

tively, we can tune in Berlin at 7 for Mozart's "Figaro."

Bizet's fascinating "Carmen" offers an excellent programme for rounding off the Christmas listening. Kalundborg is relaying it at 7 on Wednesday from the Theatre Royal.

OPERETTA.

It would almost seem as if the European ether were languishing in a state of anti-climax after the Christmas broadcasts, for, in light opera at any rate, there is little to look for next week. To-morrow Radio-Paris gives a concert version of Massenet's lesser-known "Esclarmonde" at 8.45. The inevitable Strauss, this time Johann, appears in the Vienna transmission at 6.10, the operetta being "The Queen's Kerchief." On Sunday Prague No. 1 gives a concert version of Offenbach's tuneful "Orpheus in the Underworld."

NATIONAL MUSIC.

THERE is more variety under this head. To-night Breslau is relaying public folk dancing and community singing at 7; more folk dances come from Leipzig at 7.10 on Monday, and the same station on Wednesday gives us German folk songs at 8.30.

entertainment: Japanese folk music arranged by German composers. Erich Wagner (tenor), Gartz (pianoforte), and Roemisch (cello) will be the interpreters. Yet another national programme from



GERMAINE CORNEY, of the Opera-Comique, who plays the part of Feodora in Mussorgsky's "Boris Godunov," to be broadcast from Paris P.T.T. on Thursday next at 10.30

Leipzig will be given at 7.10 on Thursday evening with "Melodies of the World," an orchestral and vocal recital.

NEW YEAR'S EVE ON THE CONTINENT.

THE German stations seem determined to give the New Year a good start. The fun begins at 7 and will go on to 2 a.m. on Wednesday, a vast inter-relay gala programme having been arranged by Berlin and Stuttgart. Hamburg has its own New Year's Eve gala beginning at 6.20.

Many long-distance listeners, however, will not concentrate on one station but will roam round the European ether, noting how each country is greeting 1936. The fact that European time is an hour ahead of ours makes it possible to enjoy the fun abroad without missing the attractions of the home programme.

SPECIAL ITEMS.

"New Year Bells"—play based on Dickens' "The Chimes" (Berlin, Tuesday, 6).

"Lohengrin" (Wagner), from the Milan "Scala" (Milan No. 1, Saturday, 7.15).

Gewandhaus Concert (Leipzig, Wednesday, 6.30).

THE AUDITOR.

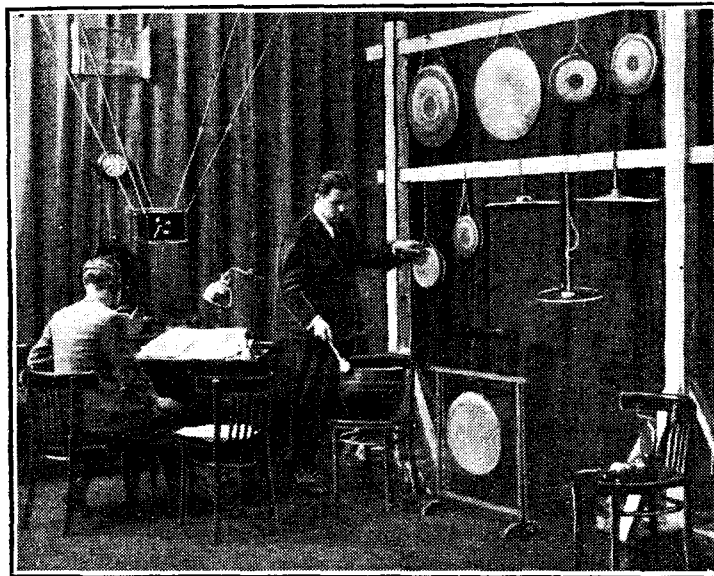

NOT A GONGSTER'S COLLEGE but the Effects studio at Wilno, Poland, photographed during the progress of a radio play. Drama is a leading feature of Polish broadcasting.

offers a relay from the Grand Theatre of Moniuszko's "Haunted Castle"; alterna-

For those who can listen to Leipzig at 3 o'clock on Thursday there is an exceptional

CHOKE INPUT FILTERS

(Concluded from page 645, December 20th issue)

Some Practical Details

IN the first instalment of this article the author compared the conventional condenser input to the smoothing system with the use of a choke in the same position. He now gives practical information on the application of the choke system

By N. PARTRIDGE, B.Sc., A.M.I.E.E.

THE most important use of the choke input circuits is in conjunction with circuits where the current varies over an appreciable range, and it is desirable to keep the voltage as nearly constant as possible. Fig. 7a gives the output voltage curves for the Mullard DW4 when used with the usual condenser input circuit of Fig. 2a, the voltage being measured across the 4-mfd. reservoir condenser. Fig. 7b gives a similar set of curves for the same value with a choke inserted between the reservoir condenser and the rectifier filament. The full-line curves of Fig. 7b give the voltages measured across the condenser, and thus include the drop through the resistance of the choke (=200 ohms). The dotted curves have been corrected for the

age at 60 mA is 23 V, only 6 per cent. Of this 23 V, 12 V is due to the resistance (200 ohms) of the choke; hence the output from the rectifier itself gives a variation of only 3 per cent. It is apparent from the above that to obtain the full advantage of the circuit the chokes must have as low a resistance as possible.

The limiting effect of the choke upon the peak current passed by the rectifier is often turned to advantage. The manufacturers of the GUI rectifier recommend the use of an input choke of 1 henry, in

Regulator Choke Specification

Core: No. 4 stampings of Silcor II (Magnetic and Electrical Alloys, Ltd.), 0.014in. thick, built up with alternate T's and U's to a core thickness of 1½in.

Winding: 3,000 turns, tapped at 620, 830, 1,030, 1,220, 1,400, 1,580, of 29 S.W.G. enamelled copper wire, layer-wound and paper interleaved.

The circuit used for the tests is shown in Fig. 8, and it should be noted that all

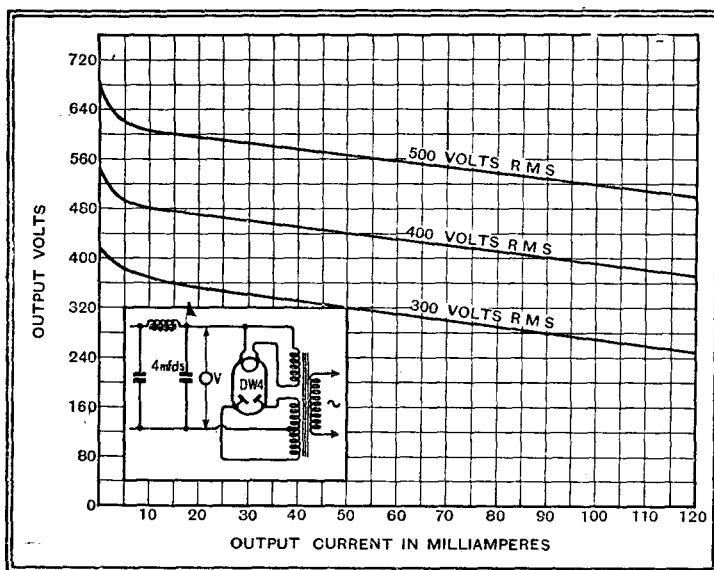

Fig. 7a.—Output voltage curves with a conventional condenser input circuit.

voltage drop through the choke, and, therefore, the slight downward slope is due to the drop in the rectifier itself. If it were not for this drop the curves would be straight lines parallel with the base of the diagram, and the voltage in each case would be the transformer voltage divided by 1.11. The points marked X on the full-line curves show clearly where the inductance of the choke employed fell below the critical value (see Fig 6), resulting in a rapid rise of output voltage.

As a typical example, assume that a circuit requires a HT voltage of, say, 400 V, and the current is to fluctuate between 60 and 120 mA, as might well be the case with a Class "B" amplifier.

The curves of Fig. 7a show that with a condenser input a transformer voltage of 420-0-420 will give 400 V DC at 120 mA. When the current falls to 60 mA the output voltage rises to 460 V, a matter of 15 per cent. increase. Turning now to the choke input curves of Fig. 7b, the transformer voltage to give 400 V DC at 120 mA will be 520-0-520, and the rise of volt-

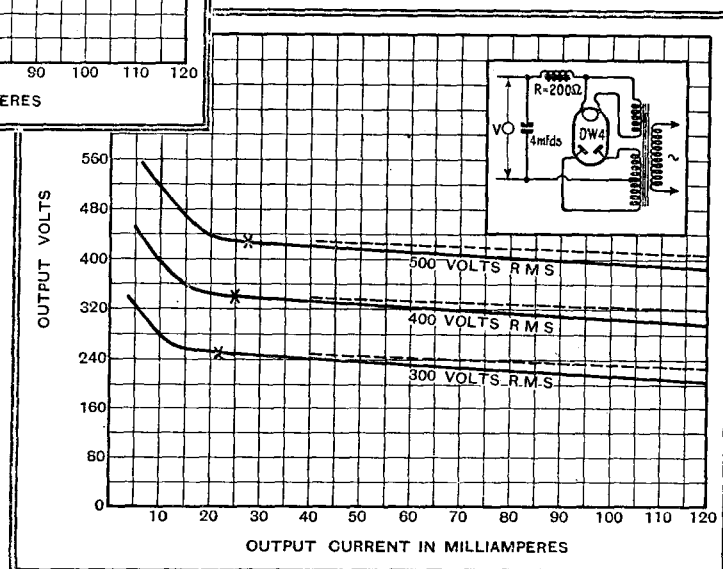

Fig. 7b.—Showing improvement in voltage regulation resulting from the use of choke input; compare with Fig. 7a

order to lessen the instantaneous load and thereby prolong the valve life. Any rectifier will be less liable to damage by slight continuous overloading if a choke input is employed.

In view of the fact that a condenser input to the filter gives an output voltage very much higher than that obtained with a choke input with the same transformer

voltages were measured across Cr, and, therefore, include the voltage drop due to the resistance of the choke. The curves of Fig. 9 give the results of tests on a Marconi MU-14 rectifier with three different transformer voltages. It can be seen that with a constant transformer voltage a different "characteristic" is obtained with each tapping. The curves relating to tap 5 (shown dotted) were taken with an 8-mfd. condenser instead of 4 mfd., as used for the other curves. The reason for this was that the inductance of this tap, at the higher values of current, resonated to the ripple frequency with 4 mfd. The substitution of the 8-mfd. condenser had little effect upon the shape of the curve but avoided the resonance. Tap 6 was not employed during the tests recorded but would also require 8 mfd.

Choke Input Filters—

It must be remembered that the choke described above was designed to enable the HT voltage to be regulated between certain limits without altering the transformer voltage. If, however, a choke were required simply to obtain the improved regulation of the choke input scheme, then a more efficient component could be obtained with the same size of core by redesigning the winding and employing an air gap, the exact figures depending upon the transformer voltage and the range of currents to be covered. The tapped choke might conveniently be referred to as a "regulator" choke and the fixed input choke as a "regulation" choke.

A rather special use for the choke input occurs in circuits where the HT supply is designed to energise the field coil of a loud speaker. To operate a permanent-magnet speaker from

unit simply to heat a resistance that plays no active part in the correct functioning of the receiver. An inspection of the families of curves in Fig. 9 shows that the correct reduction of voltage can be obtained by inserting a suitable choke between the reservoir condenser and the

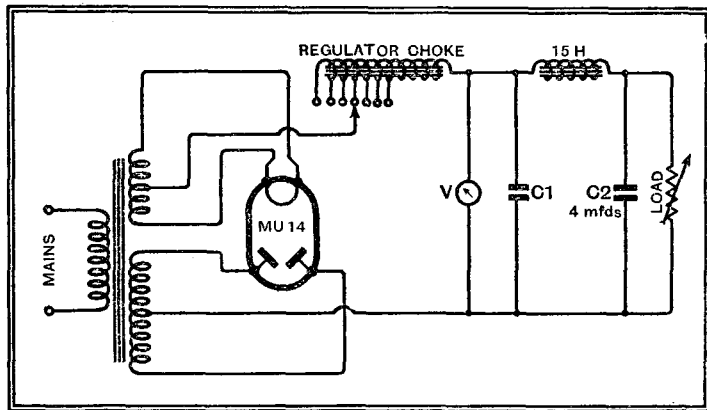

Fig. 8.—Circuit used for investigating the action of the regulator choke. C1=4 mfd. for taps 1, 2, 3, 4 and 7; 8 mfd. for taps 5 and 6.

elapse before deliveries can be made. That is only natural, for there is a deal of experimental work to be done before a commercial receiver can be put on the market by a manufacturing firm. It is largely for that reason that I have urged so strongly in these notes the desirability of starting at the earliest possible moment experimental television transmissions intended mainly for the use of manufacturers. Nothing, apparently, is going to be done until the Alexandra Palace station gets under way, and this can't be expected before the end of February. One or two firms may be in a position to supply television receivers without much delay, but I am afraid that the majority of manufacturers will regret that the experimental transmissions have been so long delayed.

Wanted, a Staff

PROBABLY you have noticed the B.B.C.'s advertisements for something like a complete staff to assist the Television Director. Rather a pity, I thought, that they didn't mention more in detail the qualifications that would be necessary in some cases. For instance, they list "Announcer (Female)" as one of their requirements, but don't say that the lady selected must possess not only a golden voice, but also the kind of face that will launch a thousand television receivers, plus charm, personality and goodness knows what else besides. Announcer (Female), forsooth!

One of the most difficult jobs when the television staff comes into action will be that of the Hostess. Her counterpart at Broadcasting House has an easy task in comparison, for microphone fright is a small thing beside televisior fright. So long as he is sufficiently soothed to keep his voice more or less steady the mere "sound" broadcaster can get away with it; but the victim in the television studio, who knows that he is going to be seen as well as heard, may take a good deal more calming down. No amount of make-up will prevent him from having that pale green feeling that we all know so well at times. Yes, the ideal television Hostess may need a bit of finding.

An Interesting Debate

ON January 11th you will hear (or perhaps I should say you may hear if you care to tune it in) an unrehearsed debate between Professor Laski and Mr. R. G. J. Boothby, M.P., the subject, or bone of contention, being "Should the House of Lords be abolished?" Before now I have had a good word to say in these notes for unrehearsed debates provided that the participants are bright and interesting speakers (as both the Professor and his opponent are) and that the chairman is one who can keep the debaters strictly in order and strictly to the point. The chairman for this particular battle of words has not yet been announced, but I expect that he will be somebody whom past experience has shown to be thoroughly up to the job. The unrehearsed debate is a first-rate item, and this time the subject chosen is a very interesting one, though I can't help wishing that it had been something non-political.

Cold Feet

WATCHING football matches is a cold business, wherefore those who sit in the stands endeavour to keep the circulation going in their feet by stamping them

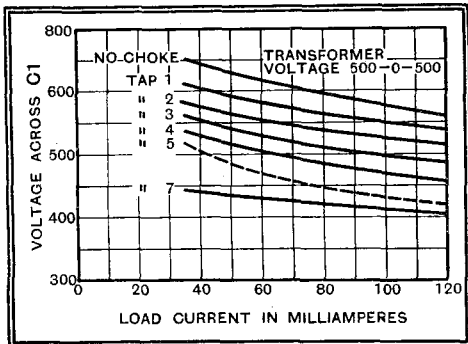
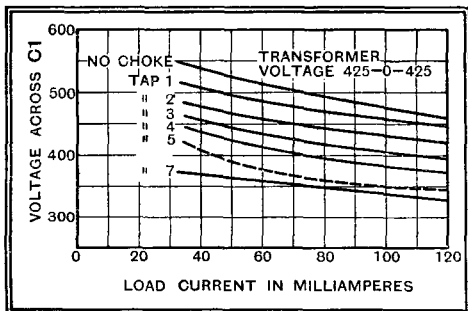
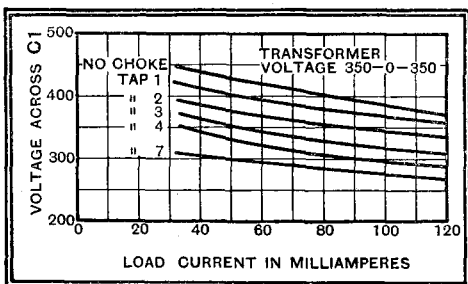

Fig. 9.—Output voltage curves with tapped regulator choke and various applied AC voltages.

such a circuit it is usual to employ an artificial field to absorb the excess voltage. This scheme is wasteful inasmuch as a number of watts are taken from the mains

rectifier filament. The advantage of so doing is that watts are not dissipated but the load on the rectifier, transformer and mains is actually reduced; thus a longer life may be expected from the rectifying valve and the mains transformer will run cooler. It should not be forgotten that a choke used as above must be paper interleaved, and, therefore, the experiment must not be attempted with an ordinary smoothing choke.

Random Radiations
By "DIALLIST"

Going Ahead in France

SINCE the 180-line television transmissions started from the Eiffel Tower, M. Mandel, the Minister of Posts and Telegraphs, has been working hard to popularise the new hobby. He has already installed viewing rooms at six different places in the city which are open to the public. As it was possible in the first instance to give television demonstrations on only one day in the week, M. Mandel has very wisely chosen Sunday, for this is the holiday day in France, when all the world and his wife and family go forth to see the sights. Sunday would not, of course, be the ideal day in this country, for we have different ideas and customs. But we do want them on a day when many people have a holiday. I hope, therefore, that the B.B.C., when it opens its viewing rooms, will not forget that Saturday afternoon is the time when the greatest number of people in this country are at leisure.

Orders for Viewing Sets

It is said that already a considerable number of television receivers have been ordered by Parisians and that several wireless manufacturing firms are going to market them. It appears, though, that some months must

on the boards at frequent intervals. Unfortunately, this kind of tap dancing comes through as a most unwelcome background to the running commentaries on football matches, particularly the rigger games at Twickenham. During the Varsity match both Captain Wakelam and "Square Five" (John Snagge) were a good deal worried by it, though I doubt if they were half as much incommoded thereby as were their listeners. Of course, you can't ask the owners of the chilly feet to keep quiet; they have paid for their seats and have every

right to stamp, even though they are thereby broadcasting to the British Isles and, by means of the Blattnerphone tape and the Empire service, to the world at large. But I do think that the B.B.C. Outside Broadcast people should try to do something to render the commentators' box rather more soundproof. Failing that, what about covering the footboards of the seats in its vicinity with felt? Or, how about providing foot-warmers—those queer things that we used to see in railway carriages years ago?

(5) Owing to the shallow cut the turntable must be on a truly horizontal plane.

(6) Fibre or "Burmese Color" needles are equally satisfactory, but they must be efficiently cut or ground.

I thoroughly endorse your correspondent's pleas for a cheap, soft wax-recording medium which can be home-baked.

Guildford. G. JARDINE.

Letters to the Editor

The Editor does not hold himself responsible for the opinions of his correspondents

HOME RECORDING

I WAS very interested to see your reference to Home Recording in the November 29th issue of your journal, and in response to your invitation to give particulars the following information may, I hope, be useful.

My apparatus has been in use for some three years, and is made up from a number of sources, as follows:—

Simpson turntable, giving a constant speed. This will drive up to ten-inch disc for cutting, but the loading on the cutter must be kept light at the maximum radius.

Cutting head and traversing screw is the Ekco Radiocorder, but the screw has been changed to allow of cutting up to twelve-inch records.

Microphone is the "Varidep," used with two stages of LF amplification and a push-pull output stage.

Alternatively, the broadcast programmes can be recorded direct. An output of some two watts is used.

The record blanks have been the real difficulty. For test work the Ekco metal records are used. These are cheap and readily obtained, and I have been surprised at the remarkably good quality which can be had from them. I find it necessary to use heavy pressure on the stylus when cutting, and have attached a lever arrangement to the cutting head for this purpose. With metal records the Simpson turntable will only drive up to eight-inch cutting; that is with the heavy cutting pressure which I use. Disadvantage of metal records is surface "hiss" and rapid wear of fibre needles. A scratch filter is used in replaying, and much useful work can be done with the metal records.

Some twelve months ago I was having considerable success with blanks issued by the Dennis Parrish Co. These were of the acid-hardening type, and could be replayed with trailing steel needles within ten minutes of cutting. For some reason, unknown to me, the firm ceased to answer any correspondence, and I have heard nothing more of what appeared likely to be a successful record blank.

At the present time I am using "Permarec" blanks, issued by the Musikon Co., of London. These are giving really excellent results. Quite a small cutting pressure is required, and in fact I have to reverse the lever previously mentioned. Quality is excellent. The records wear well, and replay with the ordinary steel needle. The drawbacks are the tedious baking process required for hardening, and the cost—three shillings per ten-inch blank.

I can assure your readers, from my own

experience, that home recording is a practical proposition, and that the apparatus need not be expensive. Apart from the microphone, which, of course, is not required if the recording is taken from the wireless programmes, the gear needed is not at all costly. A lead screw of 100 turns to the inch could be obtained, and any good pick-up would give service as a cutting head.

Considerable patience is required at the outset in making the various adjustments of cutter pressure and adjusting the input level; particularly when using the microphone. After a time, however, one develops the "feeling" of these adjustments, and I have found the making of records a most fascinating experience. With a little luck now I can make records equal in quality to the ordinary variety, and I would claim that in regard to piano recordings, the home made kind can be superior to the ordinary type.

I am now hoping, when time permits, to have a shot at making a simultaneous record of sound and sight for my home cinema.

I should be glad to see the enthusiasm for home recording rekindled, and I hope there will be a good response to your invitation.

Dudley, Worcs. A. GRAHAM.

I HAVE made a number of moderately successful records on aluminium discs with "Ekco" apparatus. First attempts were not satisfactory, but were at least encouraging.

The following points may be of value to those readers interested:—

(1) Turntable, normal commercial type driven by small induction motor (16 watts).

(2) Blanks smeared with trace of vaseline for lubrication. Cutting by steel needles as supplied for "Ekco" recorders; each needle cuts about a dozen 8in. sides.

(3) One groove cutting into next found to be due to over-modulation, particularly in the bass. About 1½ watts is ample input to recording head, and the latter's bass response was curtailed by inserting tiny slips of rubber band between the pole tips and the armature. This method is considered better than electrical attenuation, as, if the armature is not rather heavily damped, any slight play in tracking is accentuated.

(4) The playing-back head must, however, be lightly damped. Many do not realise the very big all-round improvement in reproduction that is brought about by a little attention to the rubber damping incorporated in most pick-ups. Yearly renewal of these rubbers is recommended.

SOME time ago I carried out some home-recording experiments, using "Cairmor" apparatus with sapphire and diamond stylus on aluminium discs. I was able to obtain quite pleasing results except for the bugbear of surface noise. Attempts at increasing the cutting amplitude on the record invariably lead towards track overlapping and difficulties in replaying. A deeper-cut track was tried, but introduced trouble with the motor due to the heavier load. Possibly by cutting down the bass input considerably, the problem of track overlapping might have been assisted. This meant sacrificing quality, and was considered undesirable. Comparing, say, the quality and price of records from Woolworth's with that obtainable by home recording, there appeared little to commend the latter, apart from the experimental pleasure, so home recording was in the end shelved.

I have not tried the "Permarec" type of record. The added process of stoving, outlay for stove, and expense of records have so far deterred me from giving them a trial.

O. G. COOPER.

Wembley Park, Middlesex.

I WAS very interested in the recently published letters on home recording. As a reader of your fine journal for over fifteen years, I feel I should not be doing my duty to the noble army of "fans" if I did not write you one letter in the course of so long a period.

Like Mr. Gellatly, I was able to purchase one of those "Ekco" microphones, which I found gave very good quality. I also purchased from Cairns and Morrison, of Perry Street, Tottenham Court Road, a tracking device which when firmly supported over and tightly fitting the centre spindle of the turntable gave none of the trouble mentioned by Mr. Sibun, viz., side-play. I must tell you that the tracker worked on the slide-rest, screw-cutting lathe idea, if you imagine the pick-up cutter to be the slide-rest and the long screw thread working from the centre spindle off a worm drive. The screw thread rested in a knife-edge hook, and just by pressure of its own weight drew the cutter to the centre as the turntable revolved.

This seems to answer the trouble mentioned by Mr. Quarmby as to the motor slowing up. My motor was only a Collaro single-spring one, and I cut up to an eight-inch disc without trouble. One is tempted to use too much pressure, but my experience showed that no advantage was to be gained.

It is a mistake to use an amplifier that gives too good a bass response. The ordinary balanced armature type of cutter will not handle it, and there is the trouble of deep hum. Though not troublesome to the ear it is sufficient to stop the cutter working smoothly. I found it an advantage to deliberately sacrifice the deep bass on my 4-watt amplifier, putting in a 0.125 mfd. condenser in the choke output. After all, we cannot hope to obtain perfection with the money one usually spends on a hobby, but it is surprising how good a result can be obtained. I certainly agree with Mr.

Sibun, and I think we all shall, that aluminium leaves a lot to be desired as a recording disc. When I did my recording I paid 6d. each for 6in. blanks, so for experiment I can tell you I took good care to record a few turns at a time, and then played them back as I went, noting the effects of my adjustments.

I used a sapphire-cutting stylus, and it may interest your readers to know that as a lubricant I used Meltonian shoe cream (white). There is nothing better. It must be cleaned off after with a little turpentine, making sure that it is all out of the grooves. Some more points worth mentioning are that almost any ordinary rubber-damped pick-up will work as a cutter, but beware of built-in volume controls. Ordinary dry batteries are useless for the polarising current for the mike. The current value required is, in my opinion, too high. I would suggest accumulators.

My family and I spent a most amusing evening one Christmas making records. There were roars of laughter when results were played back, especially when the fibre needle wore blunt at a most unexpected moment and stuck in the same groove for several turns.

If you want some good fun and interesting experiment I think "home recording" is worth while.

The *Wireless World* still holds my interest, and I must add to the many compliments you must receive on, I repeat, a fine journal.

London, N.21.

L. COLLIER.

ALTHOUGH I have been a reader of *The Wireless World* from No. 1, I have not previously written you in connection with any of your subject matter.

The recent correspondence regarding home recording interests me very much as I have been experimenting with this for some three years. Owing to the limitations of the plain aluminium disc, I almost gave up the matter in despair. With the advent of the coated disc home recording now becomes a possibility and proving, in my case, most successful.

My experience has shown me that the following conditions are absolutely essential to success:

(1) The driving motor must be of constant speed irrespective of fairly wide variations of load.

(2) The motor must be mechanically insulated to prevent transmission of vibration to the cutting needle.

(3) The motor must have such a power that the extra power needed for the cutting operation is a small fraction of the total available.

(4) The turntable must be massive and accurately planed.

(5) The cutting head must be absolutely rigid against side-play but perfectly free vertically.

(6) At least 6 watts undistorted output must be available.

Finally, cheap "home broadcasting" type microphones are useless on anything but speech, and poor on this.

If any of your readers are interested in an equipment which I have found most satisfactory I shall be pleased to give them full particulars if they will communicate with me.

The pleasure to be derived from a good recorder is almost endless. Amplifiers, pick-ups and microphones may be compared. Favourite broadcasts may be recorded, one's own musical and vocal efforts may be re-

corded, silent films may be given sound effects and commentaries.

May I now wish *The Wireless World* the prosperity it deserves and thank you for the

pleasure it has given me from the pre-war crystal and slider days (excluding the war period) right up to the present issue.

Grimsby, Lincs.

F. W. WOOD.

In Next Week's Issue

Imperial Short-wave Six

Waverange 6 to 100 Metres, Alternative Battery or Mains Operation

WHILST the requirements of the overseas short-wave listener differ in many important aspects from those of his *confrère* in this country, the conditions obtaining on the short waves are mutually reconcilable, in that for satisfactory and consistent results, and where loud-speaker reproduction is desired, a sensitive and selective receiver having good automatic volume control is virtually a necessity.

The Imperial Short-Wave Six is designed to comply with these requirements, and, furthermore, it has the exceptionally wide waverange of 6 to 100 metres using built-in coils and waveband switching.

It can be operated either from batteries or from the AC electric supply, no alteration being needed to the set, since it is entirely independent of its power supply equipment. This is a useful feature, though possibly of greater interest to overseas listeners who may require to use the set in towns or "up country" where battery power is the only possible method of operation.

The ultra-short waverange will, perhaps, appeal most to listeners in this country, for it covers the wavelengths to be used for high-definition television, though only the sound transmissions could, of course, be received on this set. Nevertheless, it is an exceptional advantage to be able to hear what is taking place on the ultra-short waves, especially as it does not entail any appreciable addition to the cost of the set.

LIST OF PARTS

- 1 Variable condenser, 3-gang, 0.00015 mfd. Cyldon "Bebe Special"
- 1 Dial Utility W350
- 2 Bulbs, 6 volts, 0.2 amps. Bulgin B620
- 3 IF transformers, 465 kc/s Varley Air Tune BP95
- 2 Screening boxes, 6½×6½×6 in. Magnum 1121
- Fixed Condensers
 - 5 0.0001 mfd. Dubilier 665
 - 1 0.0003 mfd. Dubilier 665
 - 1 0.003 mfd. Dubilier 670
 - 4 0.01 mfd. Dubilier 670
 - 15 0.1 mfd. tubular T.M.C.-Hydra T24
 - 1 8 mfd., electrolytic, 440 volts DC working T.C.C. 802
- 3 Pre-set condensers, 30 mmfds. (max.), mica Bulgin SW95
- 1 Pre-set condenser, 0.0005 mfd. Colvern

1 Pre-set condenser, 0.001 mfd. Formo Formodenser "G"

Resistances, 1 watt

- 1 100 ohms
- 1 250 ohms
- 12 500 ohms
- 1 5,000 ohms
- 2 10,000 ohms
- 2 25,000 ohms
- 4 100,000 ohms
- 1 250,000 ohms
- 1 500,000 ohms
- 1 1 megohm
- 1 2,000 ohms

- Polar-N.S.F.
- Polar-N.S.F.
- Polar-N.S.F.
- Polar-N.S.F.
- Polar-N.S.F.
- Polar-N.S.F.
- Polar-N.S.F.
- Polar-N.S.F.
- Polar-N.S.F.
- Polar-N.S.F.
- Dubilier

1 Potentiometer, wire wound, tapered, 5,000 ohms

Haynes Radio

1 Potentiometer, tapered, without switch, 500,000 ohms

Polar-N.S.F. V/4

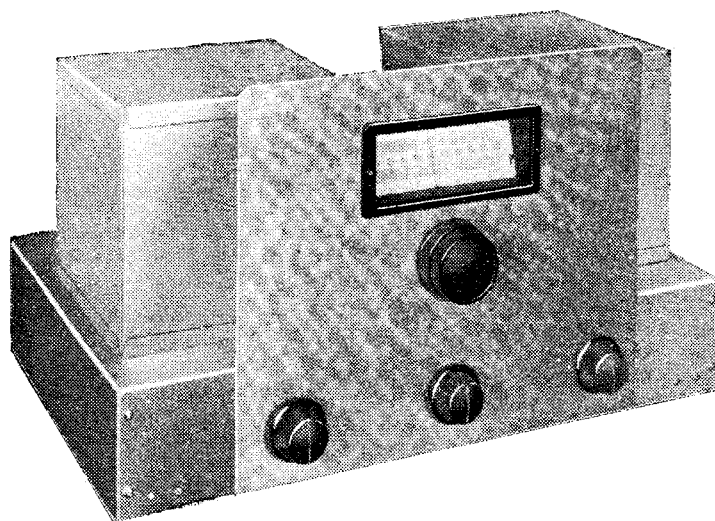

- 1 5-way multi-switch, viz., 1 driver locator with 12in. square shaft Bulgin S152
- 3 Contact units, 2-pole, without bracket Bulgin S154
- 1 Toggle on/off switch Bulgin S20T
- 5 Valve holders, 7-pin Clix Chassis Mounting Type
- 1 Valve holder, 7-pin W.E. Baseboard Type
- 3 Valve connectors, screened plug top

- 3 Valve connectors, plug top Belling-Lee 1166
- 4 Ebonite shrouded terminals, A, E, L.S. (2) Belling-Lee 1167

- 2 Lengths screened sleeving Belling-Lee "B"
- 6 Ebonite formers, 3in. length, 1in. o/a. dia., 6 wings Goltone

or Eddystone special moulded formers.

- 2 lengths 12in. 2BA brass studding with 4 nuts and washers; 2 lengths 12in. 6BA with 30 nuts and washers.

- 2 oz. No. 18 and 2 oz. No. 20 tinned copper wire, 12 lengths systoflex, small quantity No. 15 and No. 18 enamelled wire, 2 oz. No. 22 D.S.C. wire, aluminium for coil assembly, etc.

- Screws:—
- 45 6BA ½in. with nuts and washers, 2 6BA ½in. with nuts and washers, 9 4BA ½in. with nuts and washers, 8 wood screws ½in. R/hd.

Aluminium chassis, 18×12×3 in., complete with screws, nuts and washers B.T.S.

Aluminium Panel, 10×12in., No. 18 gauge, complete with screws, nuts and washers B.T.S.

- Valves:—
- 4 VP1321 Mazda, 1 H30 Osram or Marconi, 1 Pen/DD1360 Mazda.

POWER PACK

- 1 Mains transformer, primary: 200/250 volts 50 cycles. Secondaries: 250-0-250 volts 60 mA., 4 volts 1 amp. C.T., 13 volts 2 amps. C.T. Sound Sales 6VS

Smoothing choke, 45 henries Heayberd 754

Fixed condensers, electrolytic

- 1 4 mfd., 500 volts DC working Polar-N.S.F.
- 1 8 mfd., 500 volts DC working Polar-N.S.F.

1 Valve holders, 4-pin Clix Chassis Mounting Type

1 Fused mains input connector with 1 amp. fuses Belling-Lee 1098

Aluminium chassis, 9in.×5½in.×2in., complete with screws, nuts and washers B.T.S.

Valve: 1 506BU Cossor



BROADCAST BREVITIES

By
Our Special
Correspondent

19-YEAR-OLD SENORITA FRANCISCA BORIS is second announcer at Radio Catalunya (EAJ 15) and speaks Catalan and Spanish.

B.B.C.'s New Year Resolutions

NOT everyone has access to the B.B.C. in its private moments, when it lays its hand on its great warm heart and makes resolutions for leading a better life in the Year That Is To Come.

This was my privilege last week. One by one an official outlined to me the following Ten Resolutions which will govern the Corporation's outlook in the months immediately ahead.

Women Announcers

1. *Shorter symphony concerts.* The B.B.C. is really serious on this point, despite the flood of unexpected vituperation from even more unexpected quarters.

2. *Revision of previous decision not to employ women announcers.* This applies mainly to television, but there is no saying what an hour may bring forth.

3. *More Variety.* Or perhaps one should say, more frequent variety. The number of hours devoted to this feature will not be increased, but vaudeville items will have a habit of slipping into odd spaces in the programmes.

No Extra Programme Money

4. *More relays from America.* If not, Mr. Felix Greene, B.B.C. representative in New York, will want to know the reason why.

5. *More self-government for the Regions.* The tail has no wish to wag the dog, but it stands up for its inalienable right to wag itself.

6. *No extra money for programmes; more money for studios and transmitters.* Or, you can't make a silk purse out of a sow's ear.

The Mixture as Before

7. *No revolutionary attempts to break records with television.* The B.B.C. is not emulating our friends across the Channel. The motto is "Wait and See."

8. *No departures from the Sunday programme tradition.* The B.B.C. is adamant on this score, though it may concede more time to Sabbath drama.

No Breakfast Broadcasts

9. *No more studios at Broadcasting House.* The staff want room to breathe.

10. *No extension of Broadcasting hours.* People who sigh for breakfast broadcasts are doomed to another twelve months of disappointment.

What of the Ullswater Report?

Thus, in bald outline, the B.B.C.'s guiding policy for 1936. It is significant, however, that these pious resolves fail to take into account the Ullswater Committee's report, which, it seems to me, may quite easily upset some of the best laid plans at Broadcasting House.

Some of the above resolutions are not bones of contention, but there are others, notably 6, 7, 8 and 10, which might fare badly if submitted to a public enquiry.

Whatever happens, 1936 should be a very interesting year.

"Talking Book" Broadcast

SIR IAN FRASER tells me that he intends to include an actual demonstration in his talk on "The Talking Book" which he is giving in the National programme on Tuesday next at 6.55.

Those who read the article in *The Wireless World* of November 1st last on this important new aid for the blind will be interested to hear how the slow moving disc actually sounds.

Sir Ian Fraser will give the concluding passages from one side of a record and perhaps half a minute of the "turn-over."

New Dance Bands

ERIC MASCHWITZ'S recent mass audition of untried dance bands at Maida Vale has

borne fruit. Very soon the dance band sessions should lose much of the monotony which was relegated to half a dozen combinations grinding out the same tunes for ninety minutes at a stretch.

More Newcomers Soon

Here are some of the new bands: Raymond and his Romano Orchestra; Brian Lawrence and his Lansdowne House Band; Jack McCormick, of the Rialto Ballroom, Liverpool; and Al Collins and the Berkeley Hotel Orchestra.

I hear that some half-dozen other bands will make their appearance at the microphone for the first time within the next few weeks.

Run on an Old Crock

FLETCHER'S Flying Squad, as the B.B.C.'s mobile recording unit is sometimes called, has just concluded another interesting stunt for broadcasting early in the New Year.

Microphones and recorders were fitted up on an "old crock"—a motor car of pre-war vintage—so that a complete trip from start to finish was transferred to discs. Listeners will hear the crunching of the gears, the toot-toot of an Edwardian motor horn, and the panting slogs of the two-cylinder engine. All that will be missing will be the typical remarks of an Edwardian driver when the car stops on a gradient of 1 in 10,000.

Burlesquing "The Scarlet Pimpernel"

BARONESS ORCZY has given the B.B.C. permission to broadcast a burlesque of "The Scarlet Pimpernel," and it is to be undertaken by John Dighton, who wrote the recent farcical version of "Raffles."

Not even Baroness Orczy conceived that her hero would get mixed up in such adventures as befall the new Scarlet Pimpernel, played by Claude Gardner. Chauvelin becomes "Javelin," played by Bobbie Comber, and the beautiful Lady Blakeney will be portrayed by Doris Nichols, who was also in the cast of "Baffles." The burlesque will be featured in the Regional programme on January 6th.

James Watt Bicentenary

THE James Watt bicentenary is to be observed in the B.B.C. programmes by two special broadcasts—a relay of a religious service from the Town Hall, Greenock, on Sunday, January 19th, and a feature programme on Tuesday, January 21st, devised by Alastair Dunnett, a Glasgow journalist, and John Gough.

The father of the modern steam engine was born at Greenock on January 19th, 1736. He invented the steam boiler, separated from the cylinder, in 1765.

George Robey in the Studio

WITH a little imagination one can almost hear George Robey's eyebrows on those rare occasions when he broadcasts, such is his power of projecting his personality across the microphone. England's Prime Minister of Mirth is to have an hour's programme of his own on January 24th, when he takes the name part in "George for Merrie England," supported by Rupert Hazell, Elsie Day, and Mario de Pietro.

Fame in a Night

Although Robey made his first appearance at the old London Aquarium, it was at the "Star," Bermondsey, that he became famous in a night by his singing of "My Hat's a Brown One." They say in stageland that he was such a hit that he had to be sacked to give the rest of the show a chance.

The B.B.C.'s "Holiday"

OFFICIALLY speaking, the B.B.C. staff are on holiday from Wednesday, December 25th, to Sunday, December 29th inclusive, but in actual fact quite a small percentage of them will be able to enjoy an uninterrupted break. In most cases attendance is required at Broadcasting House in connection with one or other of the Christmas programmes, which demand a lot of staff work. It goes without saying that there is no holiday for producers and artists.

By cunning arrangement of shifts the engineers contrive to get a goodly proportion of holiday leave, but not one of them will have the entire five days free.

New Apparatus Reviewed

Recent Products of the Manufacturers

BURGESS SNAPLITE

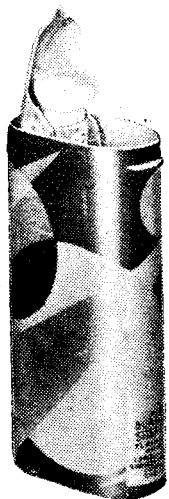

THIS small and compact electric lamp which fits a vest pocket would make a useful inspection lamp for service engineers, who often find it necessary to examine the interior of receivers in places where the lighting is none too good. It is equally useful to the ex-

New Burgess Snaplite vest pocket lamp.

perimeter and home constructor.

A point of interest regarding this new Burgess product is that the bulb is protected by a snap-type hinged top which, when opened, reveals the lamp alight. Closing the top automatically switches off the lamp. It is neat, simple to handle, and costs 1s. 6d. complete. Renewal batteries cost 6d. each.

PRISM PORTABLE AMPLIFIER

THE type ACA/51 portable amplifying equipment made by the Prism Manufacturing Company comprises a heavy-duty permanent magnet loud speaker mounted in a carrying case measuring $12\frac{1}{2} \times 20 \times 9$ in., and within the container is accommodated the amplifier unit, a piezo-electric crystal microphone and all the necessary cables. It takes but a few minutes to assemble the equipment for use, since all the parts are interconnected by cables fitted with plugs and sockets which are not interchangeable.

The amplifier unit is a fine example of compactness, for although it is rated to give an output of 8 watts maximum, it measures only $11\frac{1}{2} \times 7\frac{1}{2} \times 8\frac{1}{2}$ in., yet it is entirely self-contained. This model operates from the AC mains and consumes about 50 watts. For outdoor work it can quite easily be operated from a rotary converter driven by a car-type battery.

The minimum number of controls are fitted, there being two only; one is a volume control and the other a tone control, so that the output can be varied to best suit the acoustic conditions and the nature of the matter broadcast.

The equipment gives ample power for the normal purposes

Prism AC operated 8-watt portable amplifying equipment.

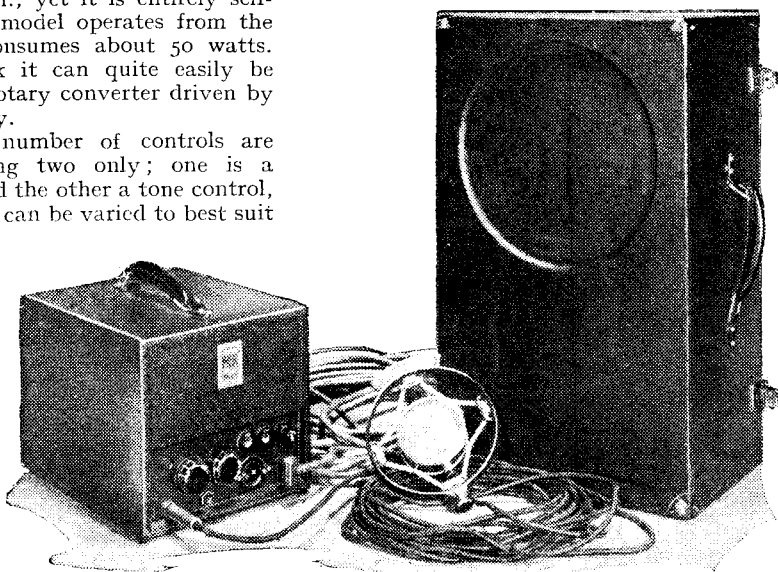

for which it will be used. No earth connection is needed, as the neutral, or earthed conductor, of the electric supply answers this purpose. With the mains plug inserted in the supply socket the right way round there was practically no hum, but if reversed it then became rather troublesome. If the amplifier is operated from a rotary converter it may be necessary, therefore, to earth one of the machine's AC terminals so as to reproduce the conditions of the ordinary domestic supply system.

Two microphones can be used simultaneously, though separate volume controls may be needed at each point, since the one incorporated is common to all input sockets. A pre-amplifying stage is embodied and is brought into use by inserting the microphone jack into the appropriate socket. The apparatus can be used, of course, for gramophone reproduction as well.

Good quality of reproduction is obtained using the crystal microphone supplied. It is sensitive and operates with a satisfactorily low background, and since the screening is particularly thorough, hum due to induction into the microphone cable is practically non-existent.

This equipment is especially well designed and ideal for use where a truly portable amplifier is needed. It has a wide scope of usefulness, and the price complete is 30 guineas.

RAYMART COMPONENTS

THE Raymart Manufacturing Co. have extended their range of short-wave components, and the new season's list includes a wide selection for use in receivers as well as for amateur transmitters. Among the latter is a sectional-wound HF choke capable of carrying 500 mA and providing a high impedance on all amateur bands up to 160 metres. It has a ceramic former

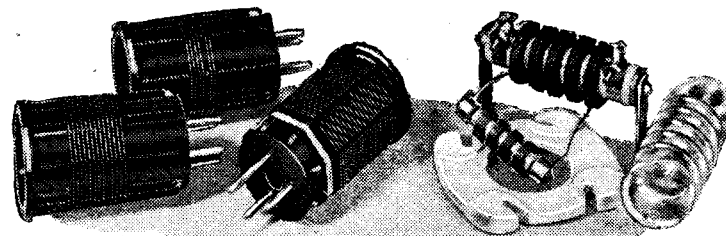

Raymart short-wave plug-in coils, HF chokes, aerial insulator, and transposition block.

$\frac{3}{8}$ in. in diameter and $2\frac{3}{4}$ in. long; the DC resistance is 27 ohms, and including mounting brackets it costs 4s. 6d.

A smaller model for receivers is available at 2s.; this has four sections wound on an isolantite core with cast end-caps and connecting wires. Both types have been tested and found entirely satisfactory for their respective functions.

For receiving there is a set of four-pin plug-in coils wound on moulded formers $1\frac{1}{2}$ in. in diameter. The three coils are stated to cover a wave range of 11 to 100 metres, and the price is 7s. 9d. the set. Fitted in an orthodox Det.-LF receiver with the aerial joined to the grid-end of the tuned coil via a small capacity, the wave band covered by each coil, using an 0.00016 mfd. condenser, was: 12.5 to 29.7, 21.5 to 50.3, and 39.5 to 93.5 metres respectively. The reaction winding is well proportioned and the coils functioned very well indeed in this simple test receiver; they are undoubtedly quite efficient.

Among other items of interest we have examined are glass aerial insulators costing 4d. each and low-loss ceramic transposition blocks for aerial downloads and feeders, these cost 6d. each, or 4s. 6d. for set of ten.

NEW FERRANTI RESISTANCE

THE range of carbon-type fixed resistances made by Ferranti, Ltd., has now been extended to include a series of two-watt models, these being similar to the half- and

Ferranti new two-watt carbon resistance.

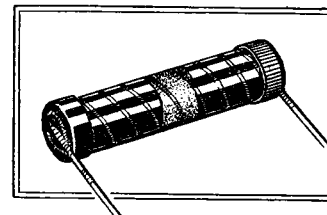

one-watt sizes, G.5 and G.1, which hitherto comprised this range.

The two-watt type is, of course, a larger resistance, and it measures $\frac{3}{8}$ in. in diameter and $1\frac{1}{2}$ in. long. Metal end-caps are fitted, to which are attached tinned-copper connecting wires. Resistance values are indicated by colours arranged in accordance with the standard code system.

Of the three specimens tested one had a resistance 1.3 per cent. greater than its marked value, while the others were 6 and 8.3 per cent. low respectively. The noise level under full load was well below the maximum permissible for this style of resistance.

These specimens were found to be quite stable on test, for after a full-load test the measured resistance, when cold, was ostensibly the same as before. The temperature rise is not excessive having regard to the power dissipated in the components. They are in every respect satisfactory and can be confidently recommended. The price is 1s. 6d. for all values up to 0.5 megohm.

Recent Inventions

Brief descriptions of interesting radio devices and improvements issued as patents are included in this section

VARIABLE-SELECTIVITY CIRCUITS

THE resonance curve of a valve amplifier is narrowed by the use of rejector circuits coupled to auxiliary grids. As shown in the Figure, the first grid is joined to the input circuit I, whilst the

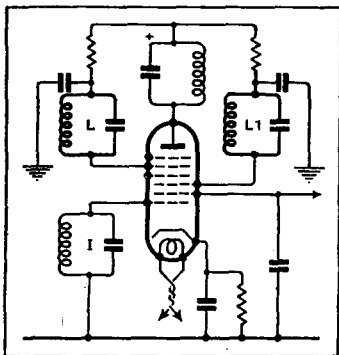

Circuit for variable selectivity.

next is a screening grid. A rejector circuit L₁, tuned to one side of the desired band, is connected to the following grid. This in turn is screened by the next grid, and the following one is coupled to a second rejector circuit L, tuned to the other side of the desired frequency band. The effect of the

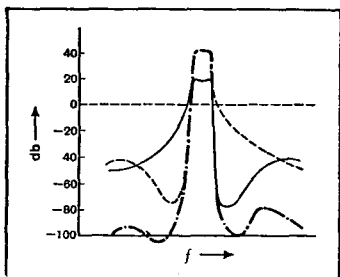

Resonance curves.

combination is shown by the heavier dotted-line portions of the resonance curve.

Patent issued to Marconi's Wireless Telegraph Co., Ltd. Convention date (Poland) 18th August, 1934. No. 431900.

PHOTO-ELECTRIC CELLS

PHOTO-ELECTRIC cells are known in which the surface of a copper electrode is covered with an oxide film in such a way that a "blocking" layer is formed between the two; and there are other types in which a "barrier" layer is used to accumulate a charge of electrons when the cell is exposed to light. The internal resistance of such cells is, however, so slight that it is difficult to amplify the pulsating currents produced by varying illumination; also the thickness of the barrier layer is found in practice to be difficult to regulate, so that different specimens of the same type of cell,

used under identical conditions, give widely-varying responses.

According to the invention, a photo-sensitive surface, such as a coating of selenium on a brass plate, is covered with a "barrier" layer of artificial resin derived from a solution of phenol. The thickness, and therefore the resistance, of this layer can be exactly determined by adjusting the amount and strength of the phenol applied. A final film of gold is applied to form the second electrode.

Patent issued to N. V. Philips' Gloeilampenfabrieken. Convention date (Germany) 25th September, 1933. No. 431746.

LIGHT VALVES

IN a light valve, suitable for television, the two Nicol prisms, together with the light-control plates, are wholly immersed in a transparent liquid, such as nitrobenzene, so as to reduce the number of surfaces at which there may be a change of refractive index. The control plates are strung between upper and lower supports, the latter being made adjustable so as to apply any required degree of tension. The whole assembly may be mounted inside a glass bulb.

Patent issued to G. W. Walton. Application date 20th November, 1933. No. 431958.

CATHODE-RAY TUBES

IN television, the spot formed by the electron stream on the screen of a cathode-ray receiver tends to produce a ring of light or "halo" which is prejudicial to clear definition. Another effect, known as "lateral-pull," which is due to the inexact alignment of the stream relative to the control electrodes, constitutes a second source of picture distortion.

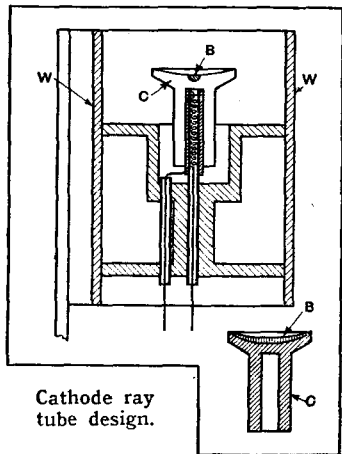

Cathode ray tube design.

According to the invention both defects are eliminated by inserting the emissive material of the cathode in a recess B, which is cut

in the cup-like depression of a mount C, accurately centred in the Wehnelt Cylinder W. The arrangement is such that all lines normal to the emissive area lie within a 10° deviation from the axis of the electrode system. The surface of the cup-shaped surface holding the emissive substance B, is highly polished to assist in concentrating the beam.

Patent issued to Radio-Akt, D. S. Loewe and K. Schlesinger. Convention date (Germany) 21st October, 1932. No. 431774.

INTERFERENCE-SUPPRESSORS

A CONDENSER-CHOKE unit is connected to the mains-supply terminals in order to suppress high-frequency impulses likely to interfere with broadcast reception. The unit comprises two chokes L, L₁, which are inserted in series with the mains supply, and two condensers C, C₁, inserted in series with the fuse F, F₁. The

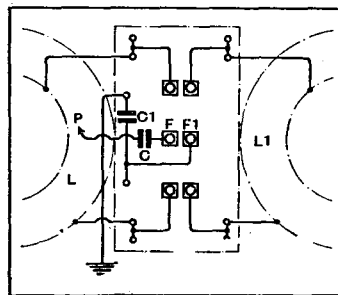

Diagram of suppressor unit.

method of connection is shown in the figure, the top and bottom terminals being joined (a) to the corresponding fuses, and (b) to the chokes L, L₁. A wander-plug P allows the chokes L, L₁, to be inserted at the input or output side, with the condenser C across the mains, one lead being earthed through the condenser C₁.

Patent issued to Belling and Lee, Ltd., and E. M. Lee. Application date 15th February, 1934. No. 431882.

DRY-CONTACT "OSCILLATORS"

PLATINUM pellets, about one-tenth of a millimetre in diameter are coated with a thin film of Vanadium oxide, and are mixed with similar pellets of Manganese oxide. The mixture possesses a negative-resistance characteristic due to the action of the residual air molecules contained in the powder, and can accordingly be used as a generator or amplifier of high-frequency oscillations. A limit to the frequencies which can be handled is normally set by the heat generated by the passage of the applied electric current. This can, however, be offset by strongly cooling the powder from outside, more particularly at the electrodes.

Patent issued to E. Habann. Convention date (Germany) 13th January, 1933. No. 431861.

LF AMPLIFIERS

TO prevent grid-current distortion, particularly in a mains-driven LF amplifier, the potentiometer P supplying grid bias to

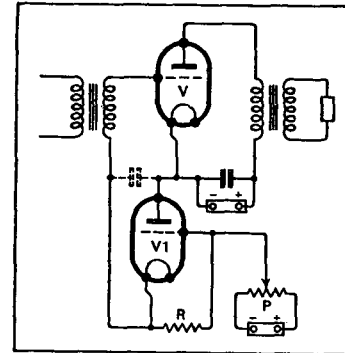

Circuit for reducing distortion.

the amplifier V is shunted by an auxiliary "control" valve V₁, or by a glow-discharge tube. A biasing resistance R in the anode-cathode circuit of the control valve V₁ serves automatically to maintain the voltage across the potentiometerappings constant, irrespective of the grid-current taken by the main amplifier V. A similar arrangement is described for automatic regulation in the case of a push-pull amplifier.

Patent issued to J. J. Numans. Convention date (Holland) 13th September, 1933. No. 432618.

TUNING CONTROL

A CLUTCH is inserted between the control knob and the variable tuning-element, so that a step-by-step adjustment can be used if desired. During the intervals between adjacent stations, the loudspeaker is automatically silenced by the action of a plunger, which rides over the teeth of a cam-wheel on the tuning-shaft and so breaks the circuit at some point between the input and the loudspeaker.

Patent issued to E. K. Cole, Ltd., and A. W. Martin. Application date 24th January, 1934. No. 432427.

DETECTOR VALVES

WHEN rectifying ultra-short waves, say, below 10 metres, the use of a grid-leak resistance of the order of 1 megohm reduces the efficiency of rectification to a low order, owing to the fact that the time taken by the electrons to pass from one electrode to another is greater than the period of the incoming oscillations.

To overcome this difficulty the inventor proposes to use a relatively high grid-bias, sufficient to produce an electron acceleration of 5 volts, in combination with a leak resistance or choke of the order of 10⁴ ohms. For anode rectification, the valve is biased so that it works on the upper bend of the characteristic curve.

Patent issued to M. von Ardenne. Convention date (Germany) 15th February, 1933. No. 432728.